

April 2024

No. TCH091
 REVISED EDITION-A

TECHNICAL & SERVICE MANUAL

<Outdoor unit>

[Model Name]

PUMY-P250YBM2
PUMY-P300YBM2
PUMY-P250YBM2-ER
PUMY-P300YBM2-ER
PUMY-P250YBM2-ET
PUMY-P300YBM2-ET

Salt proof model

PUMY-P250YBM2-BS
PUMY-P300YBM2-BS
PUMY-P250YBM2-ERBS
PUMY-P300YBM2-ERBS
PUMY-P250YBM2-ETBS
PUMY-P300YBM2-ETBS

Service Ref.

PUMY-P250YBM2.TH
PUMY-P300YBM2.TH
PUMY-P250YBM2-ER.TH
PUMY-P300YBM2-ER.TH
PUMY-P250YBM2-ET.TH
PUMY-P300YBM2-ET.TH
PUMY-P250YBM2-BS.TH
PUMY-P300YBM2-BS.TH
PUMY-P250YBM2-ERBS.TH
PUMY-P300YBM2-ERBS.TH
PUMY-P250YBM2-ETBS.TH
PUMY-P300YBM2-ETBS.TH

Revision:

- Add new indoor model for combination

TCH091 is void.

Note:

- This service manual describes technical data of the outdoor units only. As for indoor units, refer to its service manual.

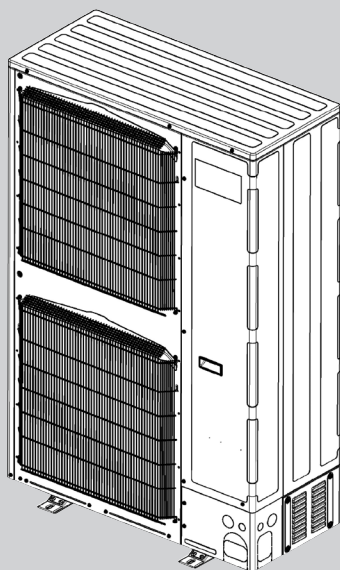

OUTDOOR UNIT

CONTENTS

1. SAFETY PRECAUTION.....	2
2. OVERVIEW OF UNITS.....	6
3. SPECIFICATIONS.....	10
4. DATA.....	11
5. OUTLINES AND DIMENSIONS.....	22
6. WIRING DIAGRAM.....	23
7. NECESSARY CONDITIONS FOR SYSTEM CONSTRUCTION.....	24
8. TROUBLESHOOTING.....	40
9. ELECTRICAL WIRING.....	111
10. REFRIGERANT PIPING TASKS.....	117
11. DISASSEMBLY PROCEDURE.....	125
12. REMOTE CONTROLLER.....	131

PARTS CATALOG (TCB091)

1-1. CAUTIONS RELATED TO NEW REFRIGERANT

Cautions for units utilizing refrigerant R410A

Preparation before the repair service

- Prepare the proper tools.
- Prepare the proper protectors.
- Provide adequate ventilation.
- After stopping the operation of the air conditioner, turn off the power-supply breaker.
- Discharge the condenser before the work involving the electric parts.

Use new refrigerant pipes.

Avoid using thin pipes.

Make sure that the inside and outside of refrigerant piping is clean and it has no contaminants such as sulfur, oxides, dirt, shaving particles, etc., which are hazardous to refrigerant cycle. In addition, use pipes with specified thickness.

Contamination inside refrigerant piping can cause deterioration of refrigerant oil, etc.

Follow the instructions below to prevent abrasive components contained in sandpaper and cutting tools from entering the refrigerant circuit because those components can cause failures of the compressor and valves.

- To deburr pipes, use a reamer or other deburring tools, not sandpaper.
- To cut pipes, use a pipe cutter, not a grinder or other tools that use abrasive materials.
- When cutting or deburring pipes, do not allow cutting chips or other foreign matters to enter the pipes.
- If cutting chips or other foreign matters enter pipes, wipe them off the inside of the pipes.

Store the piping indoors, and keep both ends of the piping sealed until just before brazing. (Leave elbow joints, etc. in their packaging.)

If dirt, dust or moisture enters into refrigerant cycle, that can cause deterioration of refrigerant oil or malfunction of compressor.

The refrigerant oil applied to flare and flange connections must be ester oil, ether oil or alkylbenzene oil in a small amount.

If large amount of mineral oil enters, that can cause deterioration of refrigerant oil, etc.

Charge refrigerant from liquid phase of gas cylinder.

If the refrigerant is charged from gas phase, composition change may occur in refrigerant and the efficiency will be lowered.

Precautions during the repair service

- Do not perform the work involving the electric parts with wet hands.
- Do not pour water into the electric parts.
- Do not touch the refrigerant.
- Do not touch the hot or cold areas in the refrigerating cycle.
- When the repair or the inspection of the circuit needs to be done without turning off the power, exercise great caution not to touch the live parts.
- When opening or closing the valve below freezing temperatures, refrigerant may spurt out from the gap between the valve stem and the valve body, resulting in injuries.

Use a vacuum pump with a reverse flow check valve.

Vacuum pump oil may flow back into refrigerant cycle and that can cause deterioration of refrigerant oil, etc.

Use the following tools specifically designed for use with R410A refrigerant.

The following tools are necessary to use R410A refrigerant.

Tools for R410A	
Gauge manifold	Flare tool
Charge hose	Size adjustment gauge
Gas leak detector	Vacuum pump adaptor
Torque wrench	Electronic refrigerant charging scale

Handle tools with care.

If dirt, dust or moisture enters into refrigerant cycle, that can cause deterioration of refrigerant oil or malfunction of compressor.

Do not use a charging cylinder.

If a charging cylinder is used, the composition of refrigerant will change and the efficiency will be lowered.

Ventilate the room if refrigerant leaks during operation. If refrigerant comes into contact with a flame, poisonous gases will be released.

Use the specified refrigerant only.

Never use any refrigerant other than that specified. Doing so may cause a burst, an explosion, or fire when the unit is being used, serviced, or disposed of. Correct refrigerant is specified in the manuals and on the spec labels provided with our products. We will not be held responsible for mechanical failure, system malfunction, unit breakdown or accidents caused by failure to follow the instructions.

Do not use refrigerant other than R410A.

If other refrigerant (R22, etc.) is used, chlorine in refrigerant can cause deterioration of refrigerant oil, etc.

Do not pump down the system when a gas leak has been detected.

The intake of air or other gases causes abnormally high pressure in the refrigeration cycle, which may cause explosion or injury.

[1] Cautions for service

- (1) Perform service after recovering the refrigerant left in unit completely.
- (2) Do not release refrigerant in the air.
- (3) After completing service, charge the cycle with specified amount of refrigerant.
- (4) If moisture or foreign matter might have entered the refrigerant piping during service, ensure to remove them.

[2] Additional refrigerant charge

When charging directly from cylinder

- (1) Check that cylinder for R410A on the market is a syphon type.
- (2) Charging should be performed with the cylinder of syphon stood vertically. (Refrigerant is charged from liquid phase.)

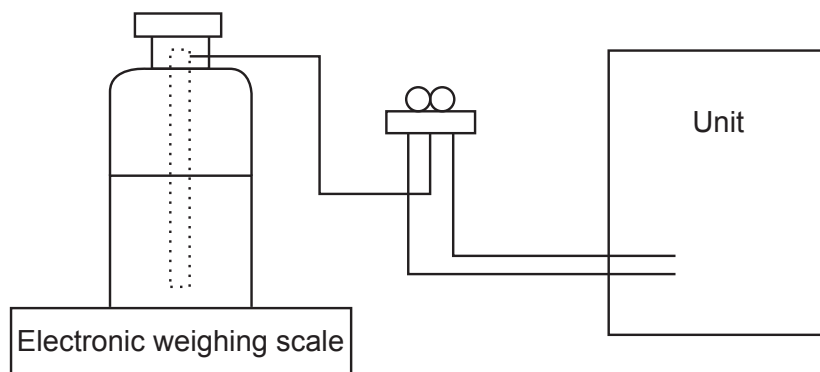

[3] Service tools

Use the below service tools as exclusive tools for R410A refrigerant.

No.	Tool name	Specifications
①	Gauge manifold	· Only for R410A
		· Use the existing fitting specifications. (UNF1/2)
		· Use high-tension side pressure of 5.3MPa·G or over.
②	Charge hose	· Only for R410A
		· Use pressure performance of 5.09MPa·G or over.
③	Electronic weighing scale	—
④	Gas leak detector	· Use the detector for R134a, R407C or R410A.
⑤	Adaptor for reverse flow check	· Attach on vacuum pump.
⑥	Refrigerant charge base	—
⑦	Refrigerant cylinder	· Only for R410A · Top of cylinder (Pink)
		· Cylinder with syphon
⑧	Refrigerant recovery equipment	—

1-2. PRECAUTIONS FOR SALT PROOF TYPE "-BS" MODEL

Although "-BS" model has been designed to be resistant to salt damage, observe the following precautions to maintain the performance of the unit.

- (1) Avoid installing the unit in a location where it will be exposed directly to seawater or sea breeze.
- (2) If the cover panel may become covered with salt, be sure to install the unit in a location where the salt will be washed away by rainwater. (If a sunshade is installed, rainwater may not clean the panel.)
- (3) To ensure that water does not collect in the base of the outdoor unit, make sure that the base is level, not at angle. Water collecting in the base of the outdoor unit could cause rust.
- (4) If the unit is installed in a coastal area, clean the unit with water regularly to remove any salt build-up.
- (5) If the unit is damaged during installation or maintenance, be sure to repair it.
- (6) Be sure to check the condition of the unit regularly.
- (7) Be sure to install the unit in a location with good drainage.

1-3. Cautions for refrigerant piping work

New refrigerant R410A is adopted for replacement inverter series. Although the refrigerant piping work for R410A is same as for R22, exclusive tools are necessary so as not to mix with different kind of refrigerant. Furthermore as the working pressure of R410A is 1.6 times higher than that of R22, their sizes of flared sections and flare nuts are different.

① Thickness of pipes

Because the working pressure of R410A is higher compared to R22, be sure to use refrigerant piping with thickness shown below. (Never use pipes of 0.7 mm or below.)

Diagram below: Piping diameter and thickness

Nominal dimensions (inch)	Outside diameter (mm)	Thickness (mm)	
		R410A	R22
1/4	6.35	0.8	0.8
3/8	9.52	0.8	0.8
1/2	12.70	0.8	0.8
5/8	15.88	1.0	1.0
3/4	19.05	1.0*	1.0
7/8	22.2	1.0*	1.0
1	25.4	1.0*	1.0

* Use 1/2 H or H pipes.

② Dimensions of flare cutting and flare nut

The component molecules in HFC refrigerant are smaller compared to conventional refrigerants. In addition to that, R410A is a refrigerant, which has higher risk of leakage because its working pressure is higher than that of other refrigerants. Therefore, to enhance airtightness and strength, flare cutting dimension of copper pipe for R410A has been specified separately from the dimensions for other refrigerants as shown below. The dimension B of flare nut for R410A also has partly been changed to increase strength as shown below. Set copper pipe correctly referring to copper pipe flaring dimensions for R410A below. For 1/2 and 5/8 inch pipes, the dimension B changes. Use torque wrench corresponding to each dimension.

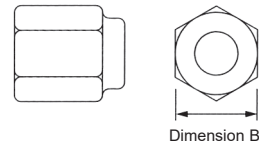
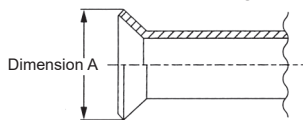

Flare cutting dimensions

Nominal dimensions (inch)	Outside diameter (mm)	Dimension A ($^{0}_{-0.4}$) (mm)	
		R410A	R22
1/4	6.35	9.1	9.0
3/8	9.52	13.2	13.0
1/2	12.70	16.6	16.2
5/8	15.88	19.7	19.4
3/4	19.05	—	23.3

Flare nut dimensions

Nominal dimensions (inch)	Outside diameter (mm)	Dimension B (mm)	
		R410A	R22
1/4	6.35	17.0	17.0
3/8	9.52	22.0	22.0
1/2	12.70	26.0	24.0
5/8	15.88	29.0	27.0
3/4	19.05	—	36.0

③ Tools for R410A (The following table shows whether conventional tools can be used or not.)

Tools and materials	Use	R410A tools	Can R22 tools be used?	Can R407C tools be used?
Gauge manifold	Air purge, refrigerant charge and operation check	Tool exclusive for R410A	×	×
Charge hose		Tool exclusive for R410A	×	×
Gas leak detector	Gas leak check	Tool for HFC refrigerant	×	○
Refrigerant recovery equipment	Refrigerant recovery	Tool exclusive for R410A	×	×
Refrigerant cylinder	Refrigerant charge	Tool exclusive for R410A	×	×
Applied oil	Apply to flared section	Ester oil, ether oil and alkylbenzene oil (minimum amount)	×	Ester oil, ether oil: ○ Alkylbenzene oil: minimum amount
Safety charger	Prevent compressor malfunction when charging refrigerant by spraying liquid refrigerant	Tool exclusive for R410A	×	×
Charge valve	Prevent gas from blowing out when detaching charge hose	Tool exclusive for R410A	×	×
Vacuum pump	Vacuum drying and air purge	Tools for other refrigerants can be used if equipped with adopter for reverse flow check	△(Usable if equipped with adopter for reverse flow)	△(Usable if equipped with adopter for reverse flow)
Flare tool*	Flaring work of piping	Tools for other refrigerants can be used by adjusting flaring dimension	△(Usable by adjusting flaring dimension)	△(Usable by adjusting flaring dimension)
Bender	Bend the pipes	Tools for other refrigerants can be used	○	○
Pipe cutter*	Cut the pipes	Tools for other refrigerants can be used	○	○
Welder and nitrogen gas cylinder	Weld the pipes	Tools for other refrigerants can be used	○	○
Refrigerant charging scale	Refrigerant charge	Tools for other refrigerants can be used	○	○
Vacuum gauge or thermistor vacuum gauge and vacuum valve	Check the degree of vacuum. (Vacuum valve prevents back flow of oil and refrigerant to thermistor vacuum gauge)	Tools for other refrigerants can be used	○	○
Charging cylinder	Refrigerant charge	Tool exclusive for R410A	×	-

×: Prepare a new tool. (Use the new tool as the tool exclusive for R410A.)

△: Tools for other refrigerants can be used under certain conditions.

○: Tools for other refrigerants can be used.

* Follow the instructions below to prevent abrasive components contained in sandpaper and cutting tools from entering the refrigerant circuit because those components can cause failures of the compressor and valves.

- To deburr pipes, use a reamer or other deburring tools, not sandpaper.
- To cut pipes, use a pipe cutter, not a grinder or other tools that use abrasive materials.
- When cutting or deburring pipes, do not allow cutting chips or other foreign matters to enter the pipes.
- If cutting chips or other foreign matters enter pipes, wipe them off the inside of the pipes.

2

OVERVIEW OF UNITS

2-1. SYSTEM CONSTRUCTION

Outdoor unit		10HP	12HP
		P250YBM2	P300YBM2
Applicable indoor unit	Capacity	Type 10 to Type 250	
	Number of units	1 to 30 units	
	Total system capacity range	50 to 130 % of outdoor unit capacity (14.0 to 36.4 kW)	50 to 130 % of outdoor unit capacity (16.8 to 43.5 kW)

Branching pipe components	CMY-Y62-G-E	CMY-Y64-G-E	CMY-Y68-G-E
	Branch header (2 branches)	Branch header (4 branches)	Branch header (8 branches)

Connectable indoor unit lineup		P10	P15	P20	P25	P32	P40	P50	P63	P71	P80	P100	P125	P140	P200	P250
1-way cassette	PMFY-P·VBM-E			•	•	•	•									
2-way cassette	PLFY-P·VLMD-E			•	•	•	•	•	•		•	•	•			
4-way cassette	PLFY-M·VEM-E			•	•	•	•	•	•		•	•	•			
	PLFY-P·VEM-E			•	•	•	•	•	•		•	•	•			
	PLFY-M·VEM6-E			•	•	•	•	•	•	•	•	•	•			
2 by 2	PLFY-P·VFM-E1		•	•	•	•	•	•								
Ceiling concealed	PEFY-P·VMS1(L)-E		•	•	•	•	•	•	•							
	PEFY-P·VMHS-E							•	•	•	•	•	•	•	•	•
	PEFY-P·VMR-E-L/R			•	•	•										
	PEFY-M·VMA(2)(L)-A			•	•	•	•	•	•	•	•	•	•	•		
	PEFY-P·VMA(L)-E1			•	•	•	•	•	•	•	•	•	•	•		
	PEFY-P·VMA(L)-E3			•	•	•	•	•	•	•	•	•	•	•		
	PEFY-P·VMH-E/E2							•	•	•	•	•	•	•	•	•
	PEFY-P·VMX(L)-E(1)		•	•	•	•	•	•								
	PEFY-M·VMA(L)-A1			•	•	•	•	•	•	•	•	•	•	•	•	
	PEFY-P·VMA(L)-E2			•	•	•	•	•	•	•	•	•	•	•		
Ceiling suspended	PCFY-P·VKM-E						•		•		•	•				
Wall mounted	PKFY-P·VKM-E								•			•				
	PKFY-P·VLM-E	•	•	•	•	•	•	•								
Ceiling concealed (Fresh air type) *1	PEFY-P·VMHS-E-F															•
Floor standing	PFFY-P·VLEM-E			•	•	•	•	•	•							
	PFFY-P·VKM-E2			•	•	•	•									
	PFFY-P·VCM-E			•	•	•	•	•	•							
Rosnay*3	GUF-·RD(H)4							•			•					

CONNECTION KIT PAC-LV11M-J

M series indoor unit²
 MSZ-EF Series
 MSZ-FH Series
 MSZ-LN Series
 MFZ-KT Series
 MSZ-AP Series
 MSZ-AY Series

M series remote controller

Note: The lineup of a connectable indoor unit depends on a district/areas/country.

Remote controller	Name	M-NET remote controller	MA remote controller
	Model number	PAR-F27MEA-E, PAR-U02MEDA	PAR-4xMAA, PAR-3xMAA ("x" represents 0 or later)
	Functions	· A handy remote controller for use in conjunction with the Melans centralized management system. · Addresses must be set.	· Address setting is not necessary.

*1 PUMY is connectable to Fresh Air type indoor unit. It is possible to connect 1 Fresh Air type indoor unit to 1 outdoor unit. (1:1 system) Operating temperature range (outdoor temperature) for fresh air type indoor units differ from other indoor units. Refer to "2-4-(3). Operating temperature range".

*2 When connecting the CONNECTION KIT (PAC-LV11M-J) and an M-series indoor unit, refer to the installation manual for the CONNECTION KIT. Refer to the connectable indoor unit lineup in "2-2 SYSTEM CONSTRUCTION (BRANCH BOX SYSTEM) for connectable indoor unit models.

*3 Do not connect Lossnay remote controller(s). (PZ-61DR-E, PZ-60DR-E, PZ-52SF-E, PZ-43SMF-E)

2-2. SYSTEM CONSTRUCTION (BRANCH BOX SYSTEM)

Outdoor unit		10HP	12HP
		P250YBM2	P300YBM2
Applicable indoor unit	Capacity	kW unit: Type 15 to Type 50	
	Number of units	2 to 12 units	
	Total system capacity range	50 to 130% of outdoor unit capacity (14.0 to 36.4 kW)	50 to 130% of outdoor unit capacity (16.8 to 43.5 kW)
Branch box that can be connected	Number of units	1 to 3 units*	

* The maximum total capacity of the units that can be connected to each branch box is 20.2kW

		Connectable indoor unit lineup											
Model type	Model name	P15	P18	P20	P22	P25	P35	P42	P50	P60	P71	P80	P100
Wall mounted	MSZ-EF·VG-E2/ER2/ET2		●		●	●	●	●					
	MSZ-EF·VGK-E1/ER1/ET1		●		●	●	●	●					
	MSZ-AP·VG(K)-E1/ER1/ET1	●		●									
	MSZ-AP·VG(K)-E2/E7					●	●	●					
	MSZ-AY·VG(K)(P)	●		●		●	●	●	●				
	MSZ-LN·VG2					●	●		●				
	MSZ-FH·VE2					●	●		●				
	MSZ-RW·VG-E1					●	●		●				
Floor standing	MFZ-KT·VG					●	●		●				
Ceiling concealed	SEZ-M·DA(L)2					●	●		●	●	●		
	PEAD-M·JA(L)2(-ET/-ER)								●	●	●		●
Ceiling suspended	PCA-M·KA2						●		●	●	●		●
2 by 2	SLZ-M·FA2	●				●	●		●				
4-Way cassette	PLA-M·EA2(.UK)						●		●	●	●		●
1-Way cassette	MLZ-KY·VG-E1		●										

Note: The lineup of a connectable indoor unit depends on a district/areas/country.

Branch box	PAC-MK54BC	PAC-MK34BC
Number of branches (Indoor unit that can be connected)	5-branches (MAX. 5 units)	3-branches (MAX. 3 units)

Note:
A maximum of 3 branch boxes can be connected to 1 outdoor unit.

2-branch pipe (joint): Optional parts							
In the case of using 1- branch box	No need						
In the case of using 2 or 3 branch boxes	<table border="1"> <thead> <tr> <th>Model name</th> <th>Connection method</th> </tr> </thead> <tbody> <tr> <td>MSDD-50AR-E</td> <td>flare</td> </tr> <tr> <td>MSDD-50BR-E</td> <td>brazing</td> </tr> </tbody> </table>	Model name	Connection method	MSDD-50AR-E	flare	MSDD-50BR-E	brazing
	Model name	Connection method					
	MSDD-50AR-E	flare					
MSDD-50BR-E	brazing						
Select a model according to the connection method.							

Option	Optional accessories of indoor units and outdoor units are available.
--------	---

2-3. SYSTEM CONSTRUCTION (MIXED SYSTEM)

Outdoor unit		10HP			12HP			
		P250YBM2			P300YBM2			
Applicable indoor unit	Capacity	CITY MULTI indoor unit *3			Type 10 to Type 250			
		Via branch box			kW unit: Type 15 to Type 50			
	Number of units		Total	Via branch box	CITY MULTI indoor	Total	Via branch box	CITY MULTI indoor
		1 branch box *1	Max. 30	Max. 5	Max. 25	Max. 30	Max. 5	Max. 25
		2 branch boxes *1	Max. 30	Max. 10	Max. 23	Max. 30	Max. 10	Max. 23
	3 branch boxes *1	Max. 30	Max. 12	Max. 22	Max. 30	Max. 12	Max. 22	
Total system capacity range		14.0 to 36.4kW			16.8 to 43.5kW			

*1 The maximum total capacity of the units that can be connected to each branch box is 20.2kW

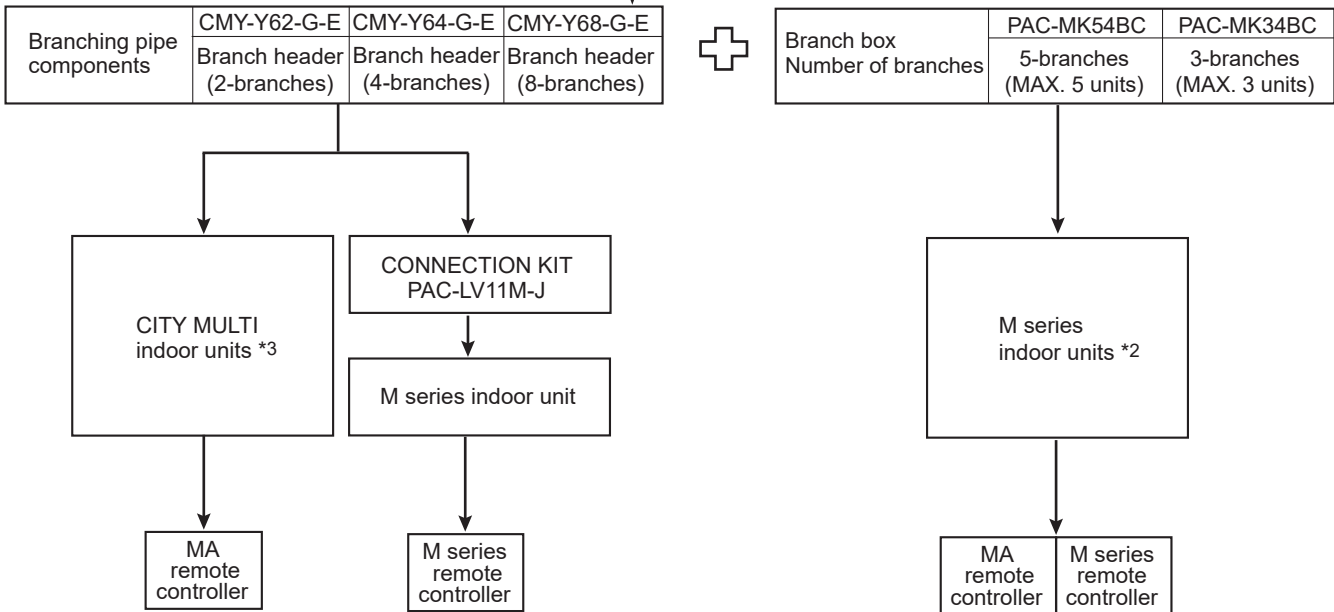

*2 Refer to "2-1. SYSTEM CONSTRUCTION" or "2-2. SYSTEM CONSTRUCTION (BRANCH BOX SYSTEM)", for more detail.

*3 PKFY-P10/15/20/25/32VLM, PFFY-P*VKM, PFFY-P*VCM, PFFY-P*VL* type indoor units cannot be used with MIXED SYSTEM.

2-4. SYSTEM SPECIFICATIONS

(1) Outdoor Unit

Outdoor unit		P250YBM2	P300YBM2
Capacity	Cooling (kW)	28.0	33.5
	Heating (kW)	31.5	37.5

Cooling/Heating capacity indicates the maximum value at operation under the following condition.

Cooling	Indoor:	D.B. 27°C/W.B. 19.0°C
	Outdoor:	D.B. 35°C
Heating	Indoor:	D.B. 20°C
	Outdoor:	D.B. 7°C/W.B. 6°C

(2) Method for identifying

■ Outdoor unit <When using model 250 >

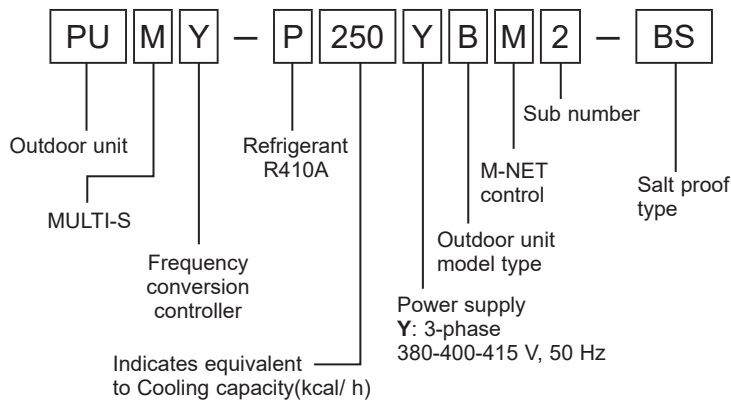

(3) Operating temperature range

	Cooling	Heating
Indoor intake air temperature	W.B. 15 to 24°C	D.B. 15 to 27°C
Outdoor intake air temperature	D.B. -5 to 52°C*1	W.B. -20 to 15°C

Notes: D.B.: Dry Bulb Temperature
W.B.: Wet Bulb Temperature

*1 10 to 52°C D.B.: When connecting PKFY-P10/15/20/25/32VLM, PFFY-P20/25/32VKM, PFFY-P20/25/32VCM, PFFY-P20/25/32VLEM, PEFY-P63/71/80VMA3-E; and M series type indoor unit.

■ When connecting fresh air type indoor unit.

• PEFY-P·VMHS-E-F

	Cooling	Heating
Indoor and outdoor intake air temperature	D.B. 17 to 43°C *2 W.B. 15.5 to 35°C	D.B. -10 to 20°C *3

*2 Thermo-OFF (FAN-mode) automatically starts if the outdoor temp. is lower than 17°C D.B.

*3 Thermo-OFF (FAN-mode) automatically starts if the outdoor temp. is higher than 21°C D.B.

3-1. OUTDOOR UNIT

Model		PUMY-P250YBM2 (-BS)	PUMY-P300YBM2 (-BS)		
Power source		3-phase, 380-400-415V, 50Hz			
Cooling capacity (Nominal)	kW ^{*1}	28.0	33.5		
	kcal/h ^{*1}	24,100	28,800		
	Btu/h ^{*1}	95,500	114,300		
	Power input kW	8.21	11.96		
	Current input A	13.41 - 12.74 - 12.28	19.54 - 18.56 - 17.89		
	EER	kW/kW	3.41	2.80	
Temp. range of cooling	Indoor temp.	W.B.	15 to 24°C		
	Outdoor temp.	D.B.	-5 to 52°C ^{*3,*4}		
Heating capacity (Nominal)	kW ^{*2}	31.5	37.5		
	kcal/h ^{*2}	27,100	32,200		
	Btu/h ^{*2}	107,500	128,000		
	Power input kW	7.91	9.69		
	Current input A	12.92 - 12.28 - 11.83	15.83 - 15.04 - 14.50		
	COP	kW/kW	3.98	3.87	
Temp. range of heating	Indoor temp.	D.B.	15 to 27°C		
	Outdoor temp.	W.B.	-20 to 15°C		
Indoor unit connectable	Total capacity		50 to 130% of outdoor unit capacity		
	Model/Max Quantity	CITY MULTI	P10 - P250/ 30		
		Branch box	kW type: P15 - P50/ 12		
		Branch box 1 unit	CITY MULTI	P10-P250/ 25	P10-P250/ 25
			Branch box	kW type: P15-P50/ 5	kW type: P15-P50/ 5
			Total (Quantity)	30	30
		Branch box 2 units	CITY MULTI	P10-P250/ 23	P10-P250/ 23
			Branch box	kW type: P15-P50/ 10	kW type: P15-P50/ 10
			Total (Quantity)	30	30
		Branch box 3 units	CITY MULTI	P10-P250/ 22	P10-P250/ 22
Branch box			kW type: P15-P50/ 12	kW type: P15-P50/ 12	
Total (Quantity)	30		30		
Sound pressure level (SPL) (measured in anechoic room)	dB <A>	55 / 61	57 / 62		
Power pressure level (PWL) (measured in anechoic room)	dB <A>	74 / 79	75 / 79		
Refrigerant piping diameter	Liquid pipe	mm (inch)	ø9.52 (3/8) ^{*5}	ø12.7 (1/2)	
	Gas pipe	mm (inch)	ø22.2 (7/8)	ø22.2 (7/8)	
FAN	Type × Quantity		Propeller Fan × 2		
	Airflow rate	m ³ /min	165/183	165/183	
		L/s	2750/3050	2750/3050	
		cfm	5826/6462	5826/6462	
	Control, Driving mechanism		DC control		
	Motor output	kW	0.375 × 2		
External static pressure		0Pa / 30Pa ^{*6}			
Compressor	Type × Quantity		Scroll hermetic compressor × 1		
	Manufacturer		Siam Compressor Industry Co., Ltd.		
	Starting method		Inverter		
	Motor output	kW	8.87	10.15	
	Case heater	kW	-	-	
Lubricant		FVC68D (3.0 liter)			
External finish		Galvanized Steel Sheet Munsell No. 3Y 7.8/1.1			
External dimension HxWxD		mm	1,662 × 1,050 × 460(+45)		
		inch	65-7/16 × 41-11/32 × 187/64 (+ 1-49/64)		
Protection devices	High pressure protection		High pressure Switch		
	Inverter circuit (COMP./FAN)		Overcurrent detection, Overheat detection (Heat sink thermistor)		
	Compressor		Compressor thermistor, Overcurrent detection, Compressor protector		
	Fan motor		Overheating, Voltage protection		
Refrigerant	Type × original charge		R410A 9.3 kg		
	Control		Linear Expansion Valve		
Net weight	kg (lb) [-BS kg (lbs)]	196 (432) [198 (437)]			
Heat exchanger		Cross Fin and Copper tube			
HIC circuit (HIC: Heat Inter-Changer)		Double pipe heat exchanger			
Defrosting method		Reversed refrigerant circuit			
Standard attachment	Installation Manual				
	Document	Grounded lead wire ×1			
Accessory	Joint pipe×1 set, Grounding lead wire ×1				
Optional parts		Joint: CMY-Y62-G-E Header: CMY-Y64/68-G-E			

*1. Nominal cooling conditions (subject to ISO 15042)

Indoor: 27°C D.B./19°C W.B. [81°F D.B./66°F W.B.], Outdoor: 35°C D.B. [95°F D.B.], Pipe length: 7.5 m [24-9/16 ft.], Level difference: 0 m [0 ft.]

*2. Nominal heating conditions (subject to ISO 15042)

Indoor: 20°C D.B. [68°F D.B.], Outdoor: 7°C D.B./6°C W.B. [45°F D.B./43°F W.B.], Pipe length: 7.5 m [24-9/16 ft.], Level difference: 0 m [0 ft.]

*3. 10 to 52°C, when connecting following models: PKFY-P10/15/20/25/32VLM, PFFY-P20/25/32VKM, PFFY-P20/25/32VCM, PFFY-P20/25/32VLEM, PEFY-P63/71/80VMA3-E; and M series type indoor unit.

*4. -15 to 52°C, when using an optional air protect guide [PAC-SK21AG-E]. However, this condition does not apply to the indoor unit listed in *3.

*5. Liquid pipe diameter: 12.7mm, when further piping length is longer than 90m, and when PEFY-P200 or P250 is connected.

*6. It is possible to set the External static pressure to 30 Pa by Dip Switch.

Notes:

• Nominal conditions *1, *2 are subject to ISO15042

• Due to continuing improvement, above specifications may be subject to change without notice.

Unit converter

kcal/h = kW × 860
Btu/h = kW × 3,412
cfm = m³/min × 35.31
lb = kg/0.4536

Above specification data is subject to rounding variation.

4-1. SELECTION OF COOLING/HEATING UNITS

<Cooling>

Design Condition	
Outdoor Design Dry Bulb Temperature	39°C
Total Cooling Load	25.0 kW
Room1, Room2	
Indoor Design Dry Bulb Temperature	27°C
Indoor Design Wet Bulb Temperature	20°C
Cooling Load	5.4 kW
Room3, Room4	
Indoor Design Dry Bulb Temperature	24°C
Indoor Design Wet Bulb Temperature	18°C
Cooling Load	7.1 kW
<Other>	
Indoor/Outdoor Equivalent Piping Length	20 m

Capacity of indoor unit

Unit: kW

P-FY Series	Model Number for indoor unit	Model 10	Model 15	Model 20	Model 25	Model 32	Model 40	Model 50	Model 63	Model 71	Model 80	Model 100	Model 125	Model 140	Model 200	Model 250
	Model Capacity	1.2	1.7	2.2	2.8	3.6	4.5	5.6	7.1	8.0	9.0	11.2	14.0	16.0	22.4	28.0
M Series S Series P Series	Model Number for indoor unit	Model 15	Model 18	Model 20	Model 22	Model 25	Model 35	Model 42	Model 50	Model 60	Model 71	Model 100	—	—	—	—
	Model Capacity	1.5	1.8	2.0	2.2	2.5	3.5	4.2	5.0	6.0	7.1	10.0	—	—	—	—

1. Cooling Calculation

(1) Temporary Selection of Indoor Units

Room1, Room2	PEFY-P50	5.6 kW (Rated)
Room3, Room4	PEFY-P71	8.0 kW (Rated)

(2) Total Indoor Units Capacity

$$P50 + P50 + P71 + P71 = P242$$

(3) Selection of Outdoor Unit

The P250 outdoor unit is selected as total indoor units capacity is P242
PUMY-P250YBM2 **28.0 kW**

(4) Total Indoor Units Capacity Correction Calculation

Room1, Room2	Indoor Design Wet Bulb Temperature Correction (20°C)	1.03 (Refer to Figure 1)
Room3, Room4	Indoor Design Wet Bulb Temperature Correction (18°C)	0.94 (Refer to Figure 1)
Total Indoor Units Capacity (CTi)		
CTi = \sum (Indoor Unit Rating \times Indoor Design Temperature Correction)		
= $5.6 \times 1.03 + 5.6 \times 1.03 + 8.0 \times 0.94 + 8.0 \times 0.94$		
= 26.6 kW		

(5) Outdoor Unit Correction Calculation

Outdoor Design Dry Bulb Temperature Correction (39°C)	0.94 (Refer to Figure 2)
Piping Length Correction (20 m)	0.97 (Refer to Figure 3)

Total Outdoor Unit Capacity (CTo)

$$\begin{aligned} CT_o &= \text{Outdoor Rating} \times \text{Outdoor Design Temperature Correction} \times \text{Piping Length Correction} \\ &= 28.0 \times 0.94 \times 0.97 \\ &= 25.5 \text{ kW} \end{aligned}$$

(6) Determination of Maximum System Capacity

Comparison of Capacity between Total Indoor Units Capacity (CTi) and Total Outdoor Unit Capacity (CTo)

$$\begin{aligned} CT_i &= 26.6 > CT_o = 25.5, \text{ thus, select } CT_o. \\ CT_x &= CT_o = 25.5 \text{ kW} \end{aligned}$$

(7) Comparison with Essential Load

Against the essential load 25.0kW, the maximum system capacity is 25.5 kW: Proper outdoor units have been selected.

(8) Calculation of Maximum Indoor Unit Capacity of Each Room

CTx = CTo, thus, calculate by the calculation below

Room1, 2

$$\begin{aligned} &\text{Maximum Capacity} \times \text{Room1, or 2 Capacity after the Temperature Correction} / (\text{Room1 to 4 Total Capacity after the Temperature Correction}) \\ &= 25.5 \times (5.6 \times 1.03) / (5.6 \times 1.03 \times 2 + 8.0 \times 0.94 \times 2) \\ &= 5.5 \text{ kW} \quad \text{OK: fulfills the load 5.4 kW} \end{aligned}$$

Room3, 4

$$\begin{aligned} &\text{Maximum Capacity} \times \text{Room3 or 4 Capacity after the Temperature Correction} / (\text{Room1 to 4 Total Capacity after the Temperature Correction}) \\ &= 25.5 \times (8.0 \times 0.94) / (5.6 \times 1.03 \times 2 + 8.0 \times 0.94 \times 2) \\ &= 7.2 \text{ kW} \quad \text{OK: fulfills the load 7.1 kW} \end{aligned}$$

Note: If CTx = CTi, please refer to the <Heating> section to calculate the Maximum Indoor Unit Capacity of Each Room. Go on to the heating trial calculation since the selected units fulfill the cooling loads of Room 1 to 4.

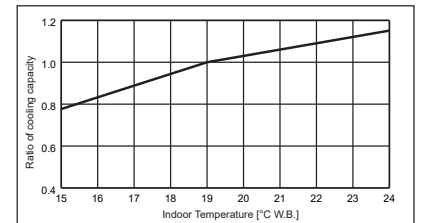

Figure 1 Indoor unit temperature correction
To be used to correct indoor unit only

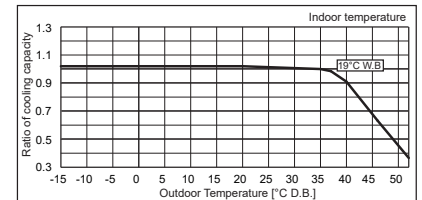

Figure 2 Outdoor unit temperature correction
To be used to correct outdoor unit only

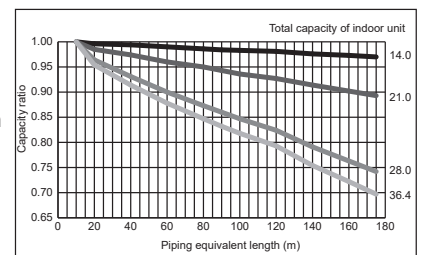

Figure 3 Correction of refrigerant piping length

<Heating>

Design Condition	
Outdoor Design Wet Bulb Temperature	2°C
Total Heating Load	25.0 kW
Room1, Room2	
Indoor Design Dry Bulb Temperature	24°C
Heating Load	6.0 kW
Room3, Room4	
Indoor Design Dry Bulb Temperature	25°C
Heating Load	6.5 kW
<Other>	
Indoor/Outdoor Equivalent Piping Length	30 m

Capacity of indoor unit

Unit: kW

P*FY Series	Model Number for indoor unit	Model 10	Model 15	Model 20	Model 25	Model 32	Model 40	Model 50	Model 63	Model 71	Model 80	Model 100	Model 125	Model 140	Model 200	Model 250
	Model Capacity	1.4	1.9	2.5	3.2	4.0	5.0	6.3	8.0	9.0	10.0	12.5	16.0	18.0	25.0	31.5
M Series	Model Number for indoor unit	Model 15	Model 18	Model 20	Model 22	Model 25	Model 35	Model 42	Model 50	Model 60	Model 71	Model 100	—	—	—	—
	Model Capacity	1.7	2.1	2.3	2.5	2.9	4.0	4.8	5.7	6.9	8.1	11.2	—	—	—	—

2. Heating Calculation

(1) Temporary Selection of Indoor Units

- Room1, Room2
PEFY-P63 **8.0 kW (Rated)**
- Room3, Room4
PEFY-P71 **9.0 kW (Rated)**

(2) Total Indoor Units Capacity

P63 + P63 + P71 + P71 = P268

(3) Selection of Outdoor Unit

The P300 outdoor unit is selected as total indoor units capacity is P268
PUMY-P300YBM2 **37.5 kW**

(4) Total Indoor Units Capacity Correction Calculation

- Room1, Room2
Indoor Design Dry Bulb Temperature Correction (24°C) 0.84 (Refer to Figure 4)
- Room3, Room4
Indoor Design Dry Bulb Temperature Correction (25°C) 0.80 (Refer to Figure 4)
- Total Indoor Units Capacity (CTi)
CTi = Σ (Indoor Unit Rating × Indoor Design Temperature Correction)
= 8.0×0.84 + 8.0×0.84 + 9.0×0.80 + 9.0×0.80
= 27.8 kW

(5) Outdoor Unit Correction Calculation

- Outdoor Design Wet Bulb Temperature Correction (2°C) 1.00 (Refer to Figure 5)
- Piping Length Correction (30 m) 0.98 (Refer to Figure 6)
- Defrost Correction 0.89 (Refer to Table 1)
- Total Outdoor Unit Capacity (CTo)
CTo = Outdoor Unit Rating × Outdoor Design Temperature Correction × Piping Length Correction × Defrost Correction
= 37.5 × 1.00 × 0.98 × 0.89
= 32.7 kW

(6) Determination of Maximum System Capacity

Comparison of Capacity between Total Indoor Units Capacity (CTi) and Total Outdoor Unit Capacity (CTo)
CTi = 27.8 < CTo = 32.7, thus, select CTi.
CTx = CTi = 27.8 kW

(7) Comparison with Essential Load

Against the essential load 25.0kW, the maximum system capacity is 27.8 kW: Proper outdoor units have been selected.

(8) Calculation of Maximum Indoor Unit Capacity of Each Room

- CTx = CTi, thus, calculate by the calculation below
- Room1, 2
Indoor Unit Rating × Indoor Design Temperature Correction
= 8.0 × 0.84
= 6.7 kW **OK: fulfills the load 6.0 kW**
- Room3, 4
Indoor Unit Rating × Indoor Design Temperature Correction
= 9.0 × 0.80
= 7.2 kW **OK: fulfills the load 6.5 kW**

Table 1 Table of correction factor at frost and defrost

Outdoor Intake Temperature (°C W.B.)	6	4	2	0	-2	-4	-6	-8	-10	-15	-20
Correction factor	1.00	0.98	0.89	0.88	0.89	0.90	0.95	0.95	0.95	0.95	0.95

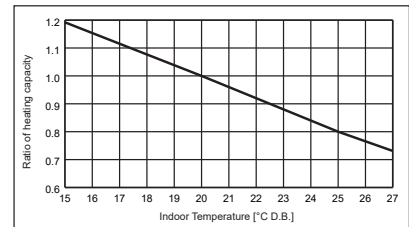

Figure 4 Indoor unit temperature correction
To be used to correct indoor unit only

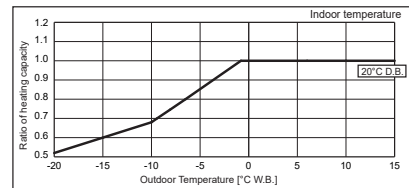

Figure 5 Outdoor unit temperature correction
To be used to correct outdoor unit only

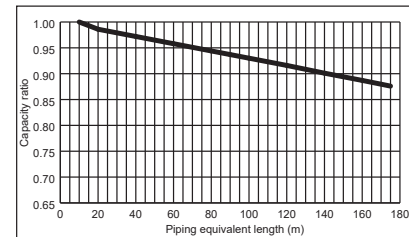

Figure 6 Correction of refrigerant piping length

4-2. CORRECTION BY TEMPERATURE

The outdoor units have varied capacity at different designing temperature. Using the nominal cooling/heating capacity value and the ratio below, the capacity can be observed at various temperature.

<Cooling>

Figure 7 Indoor unit temperature correction

To be used to correct indoor unit capacity only

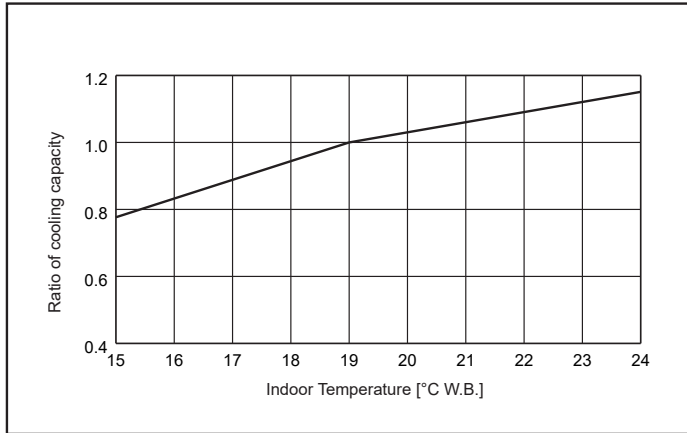
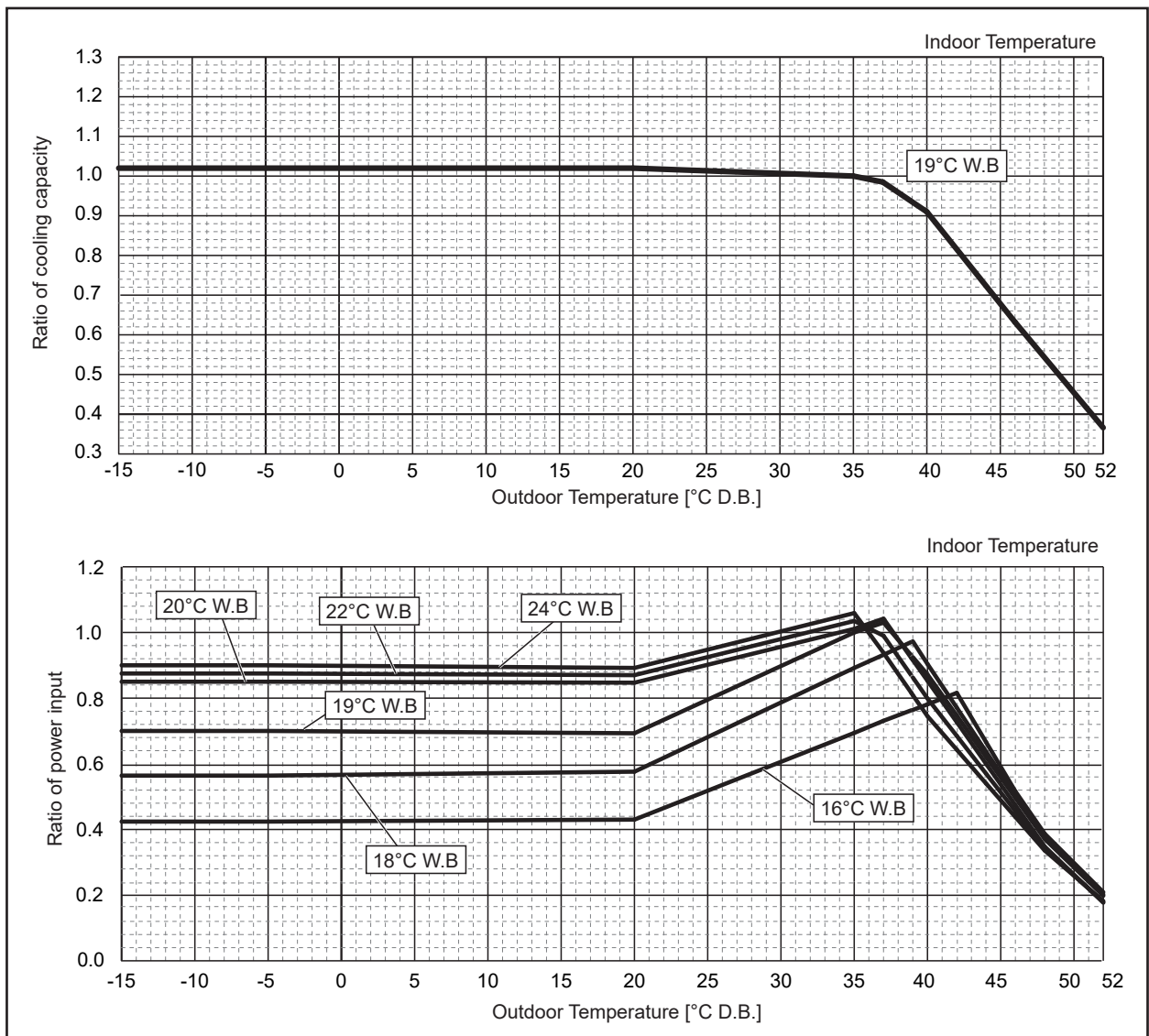

Figure 8 Outdoor unit temperature correction

To be used to correct outdoor unit capacity only



<Heating>

Figure 9 Indoor unit temperature correction
To be used to correct indoor unit capacity only

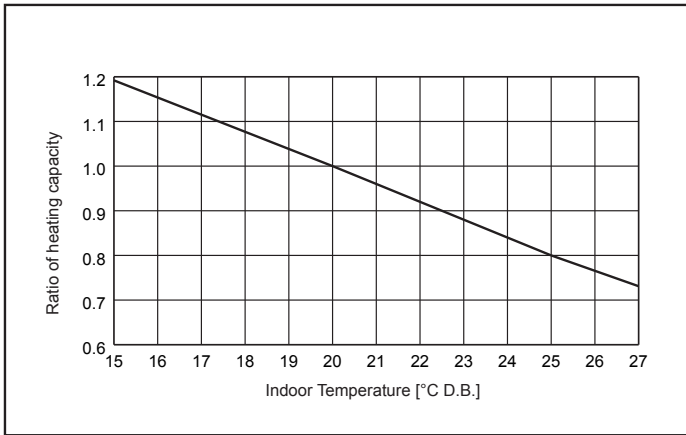
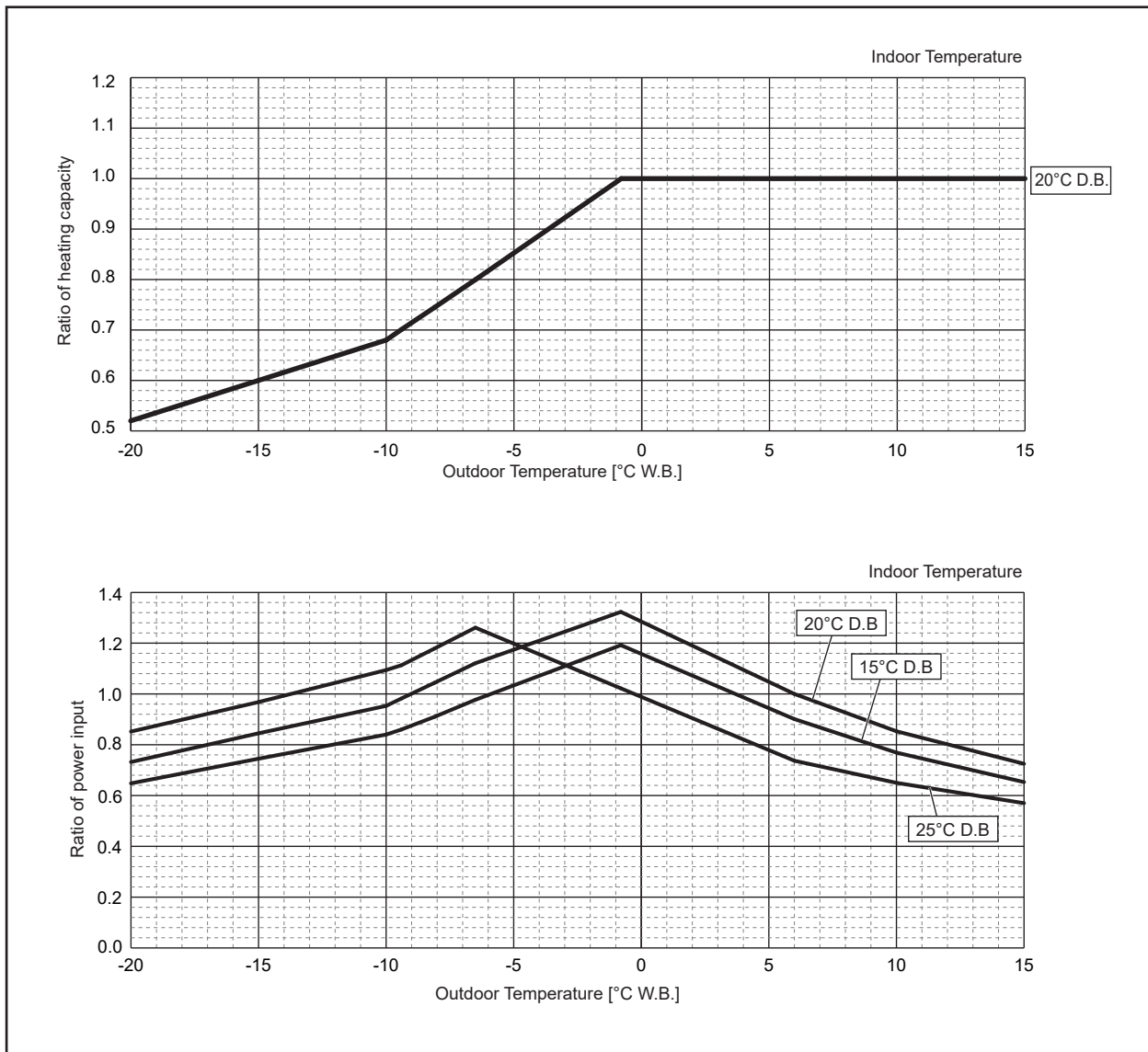

Figure 10 Outdoor unit temperature correction
To be used to correct outdoor unit capacity only



4-3. STANDARD CAPACITY DIAGRAM

Before calculating the sum of total capacity of indoor units, please convert the value into the kW model capacity following the formula on "4-1. SELECTION OF COOLING/HEATING UNITS".

4-3-1. PUMY-P250YBM2

<Cooling>

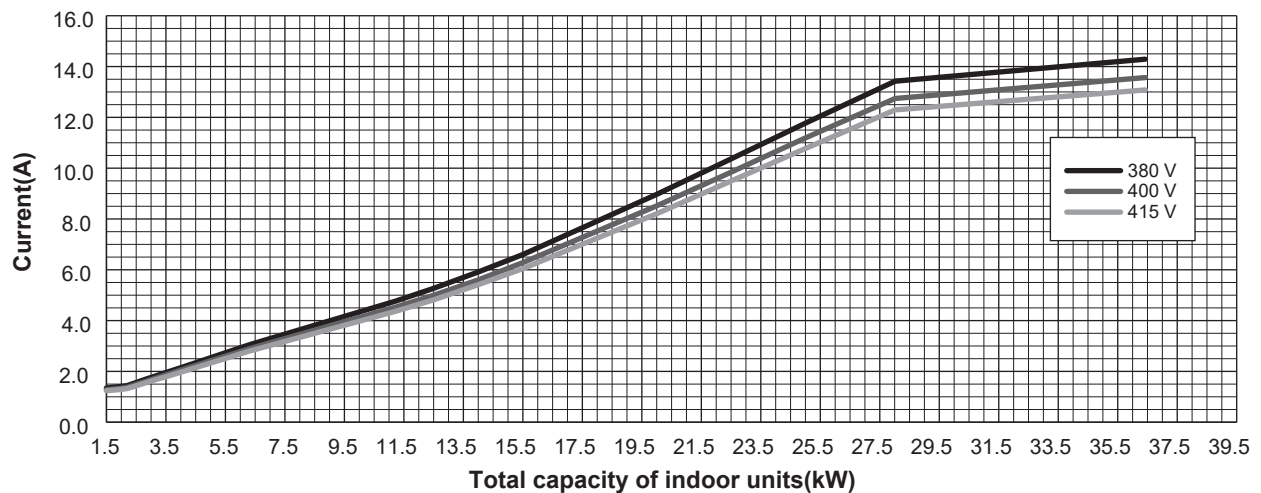
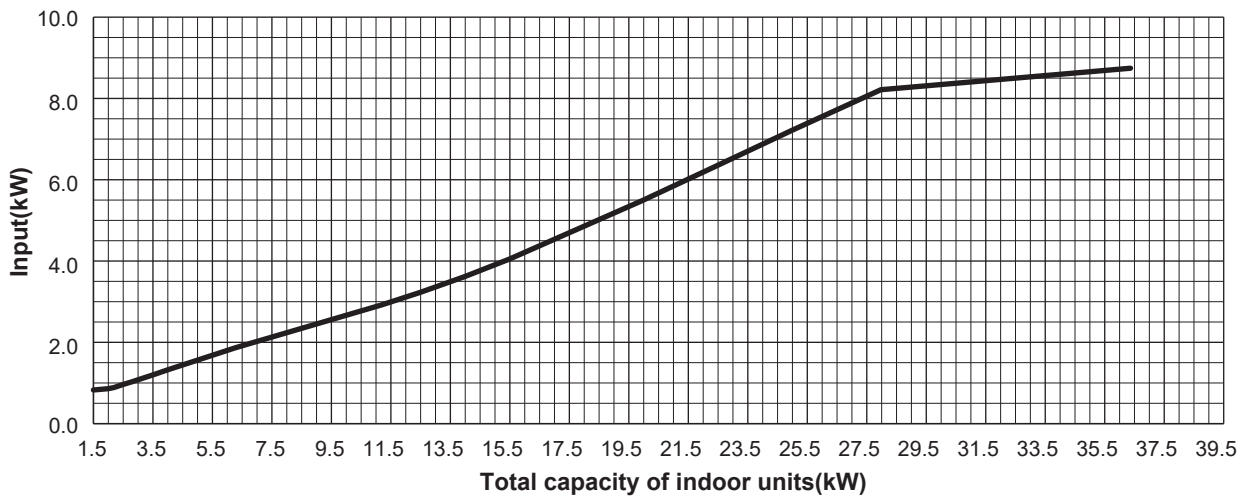
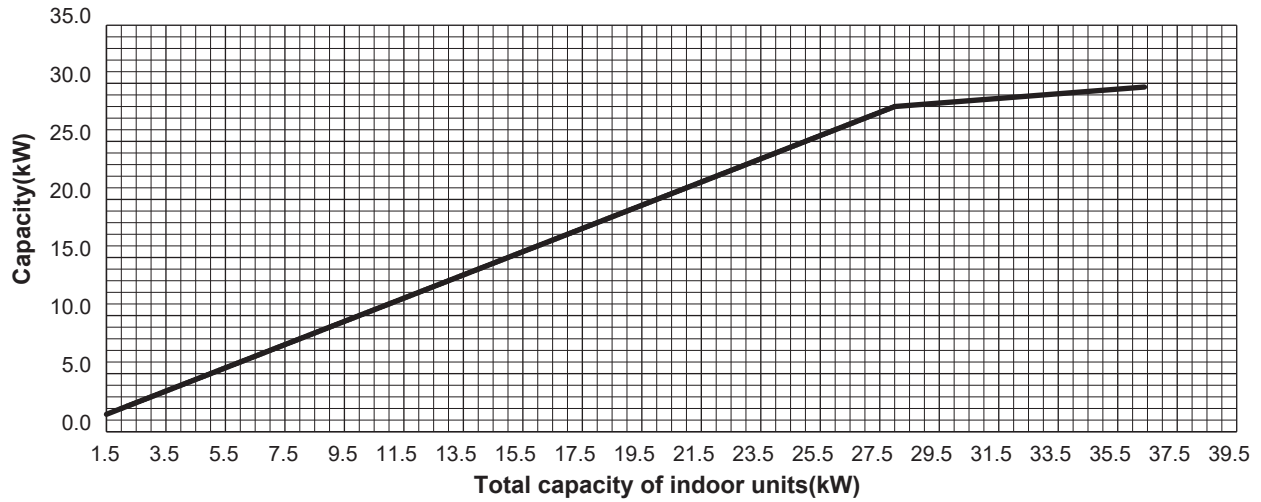

4-3-2. PUMY-P300YBM2

<Cooling>

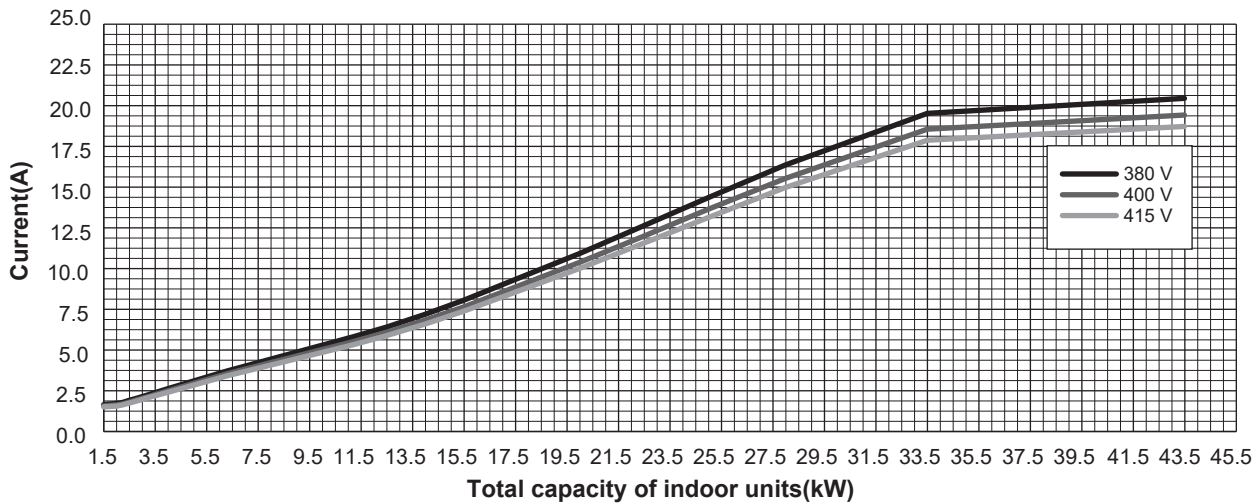
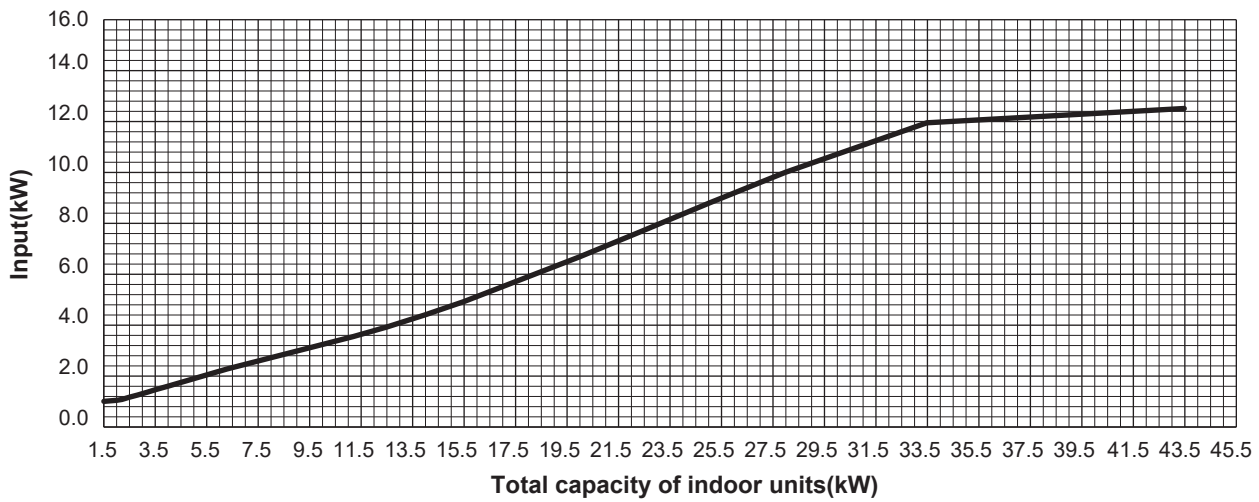
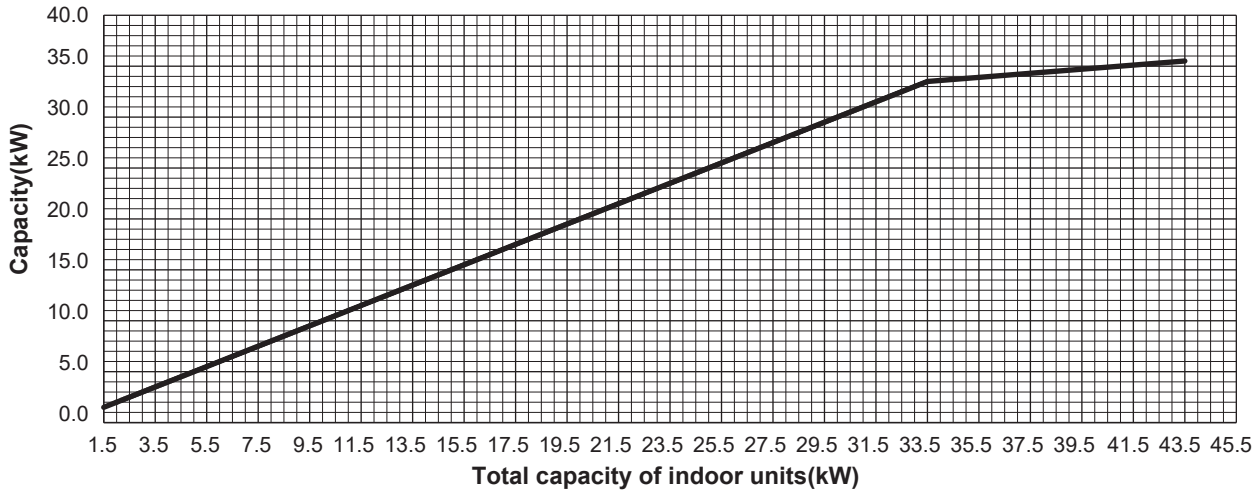

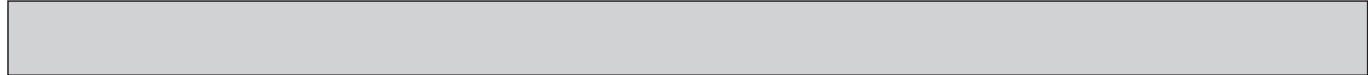

4-3-3. PUMY-P250YBM2

<Heating>

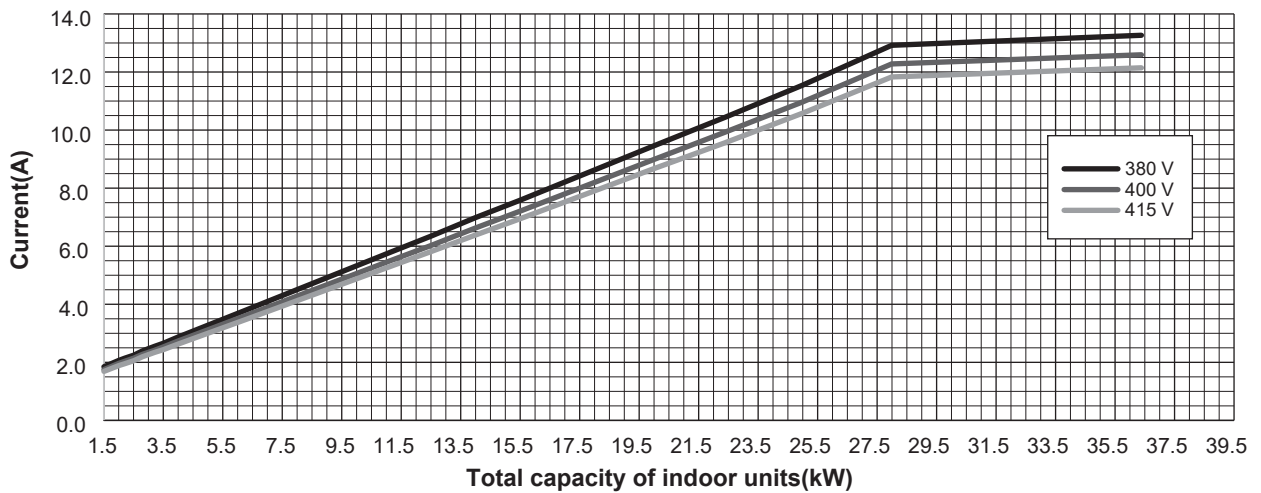
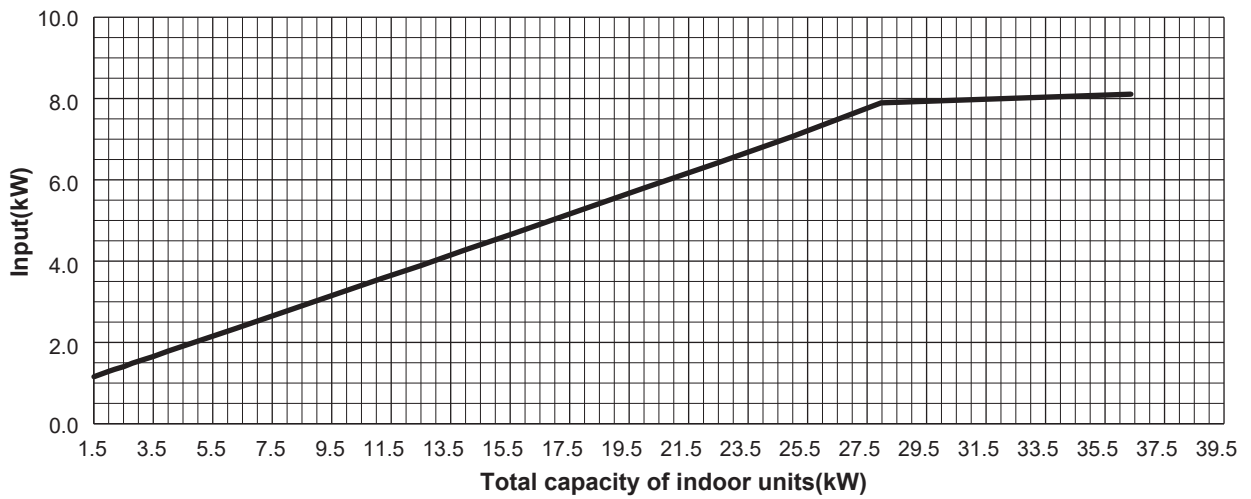
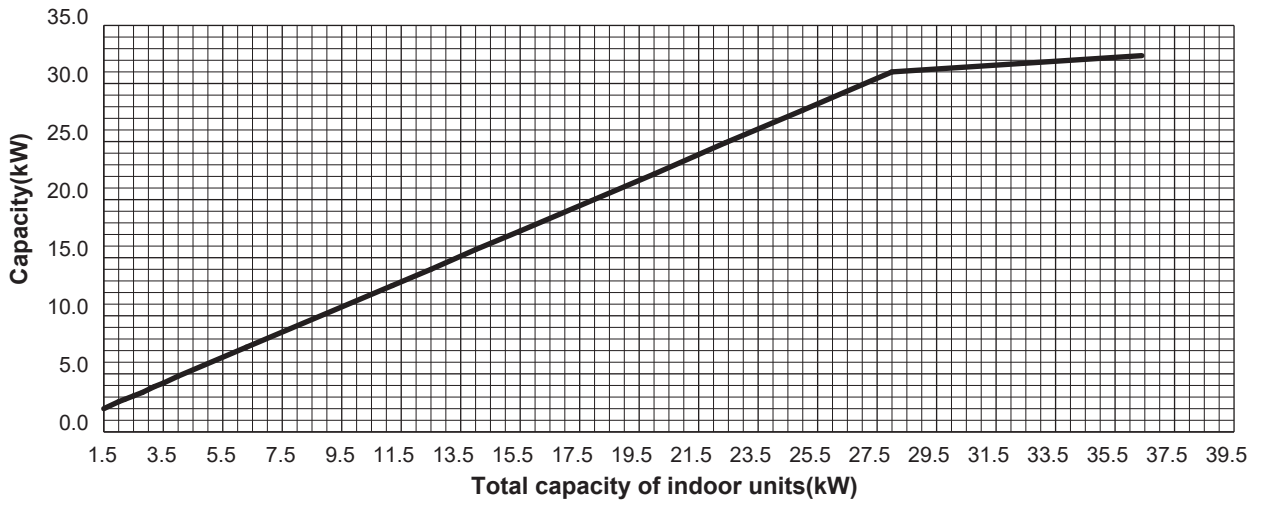

4-3-4. PUMY-P300YBM2

<Heating>

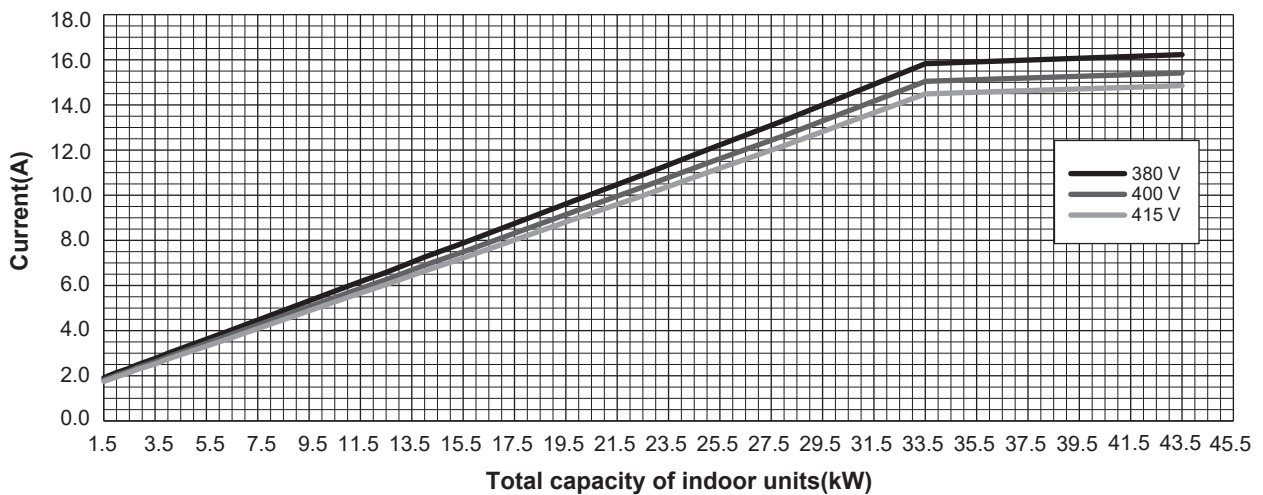
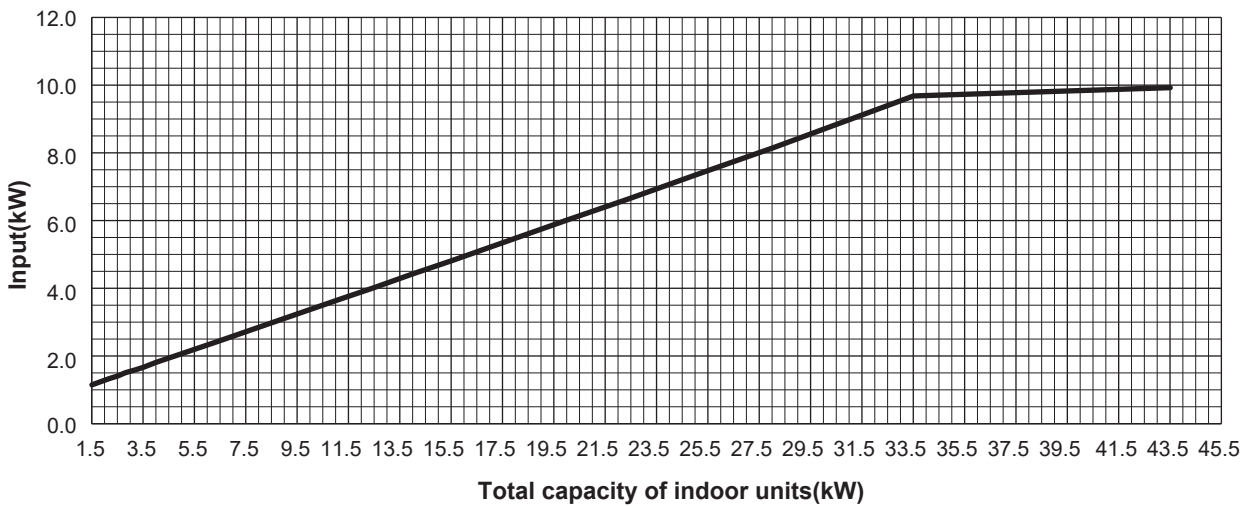
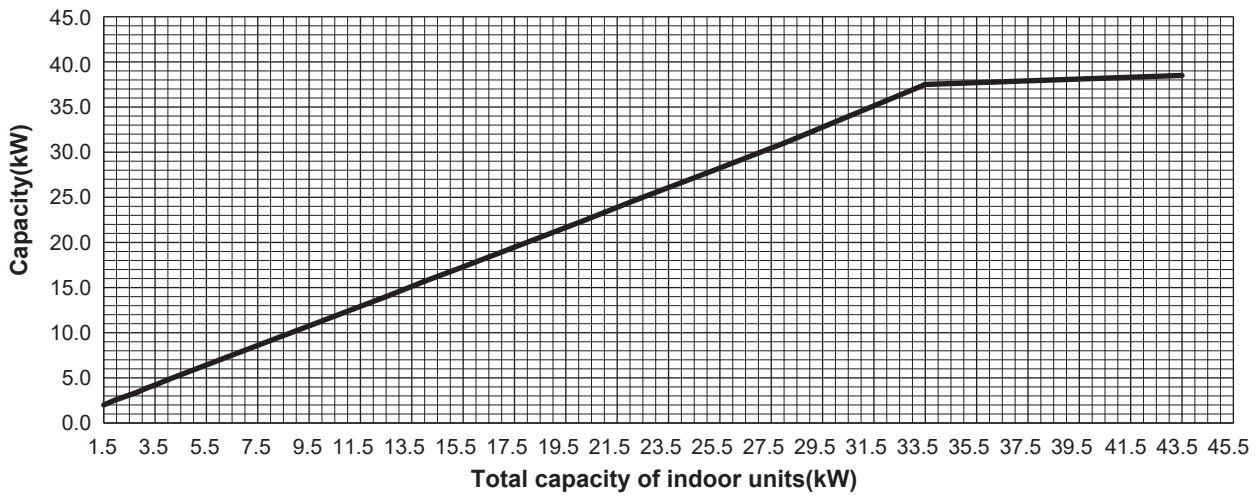

4-4. CORRECTING CAPACITY FOR CHANGES IN THE LENGTH OF REFRIGERANT PIPING

- During cooling, obtain the ratio (and the equivalent piping length) of the outdoor units rated capacity and the total in-use indoor capacity, and find the capacity ratio corresponding to the standard piping length from Figure 11. Then multiply by the cooling capacity from Figure 7 and 8 in "4-2. CORRECTION BY TEMPERATURE" to obtain the actual capacity.
- During heating, find the equivalent piping length, and find the capacity ratio corresponding to standard piping length from Figure 12. Then multiply by the heating capacity from Figure 9 and 10 in "4-2. CORRECTION BY TEMPERATURE" to obtain the actual capacity.

(1) Capacity Correction Curve

Figure 11 PUMY-P250YBM2

<Cooling>

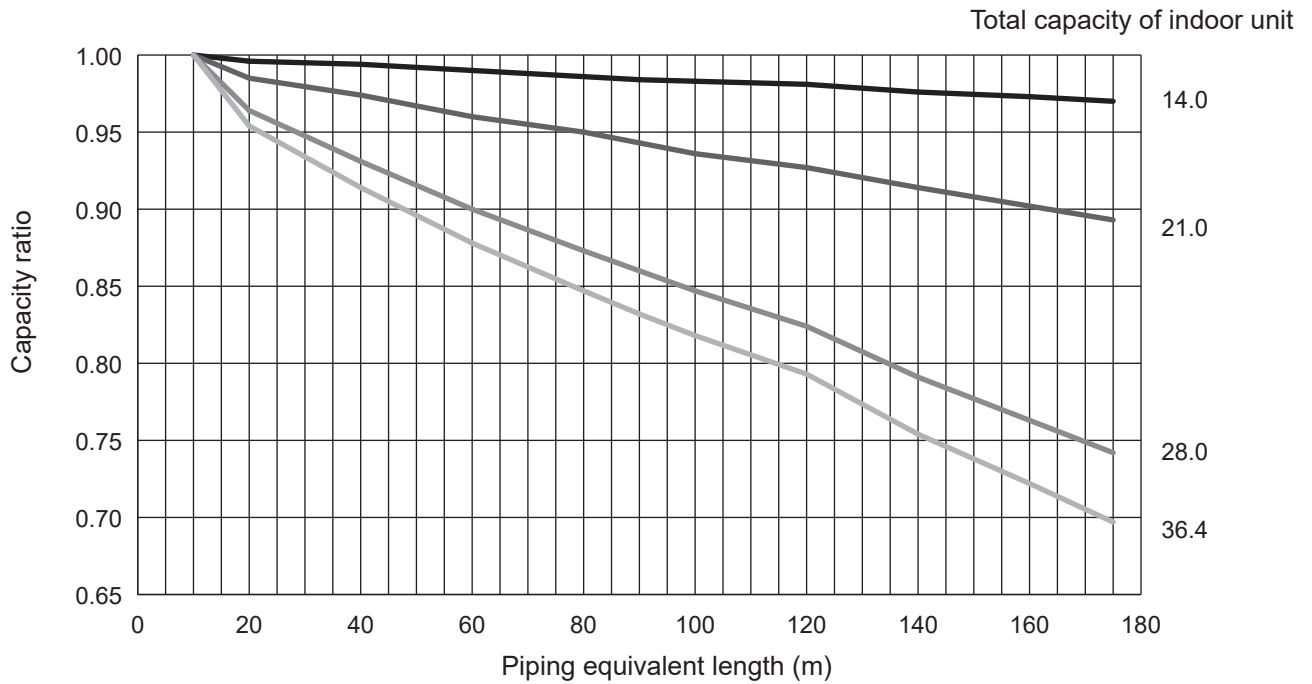

Figure 12 PUMY-P250YBM2

<Heating>

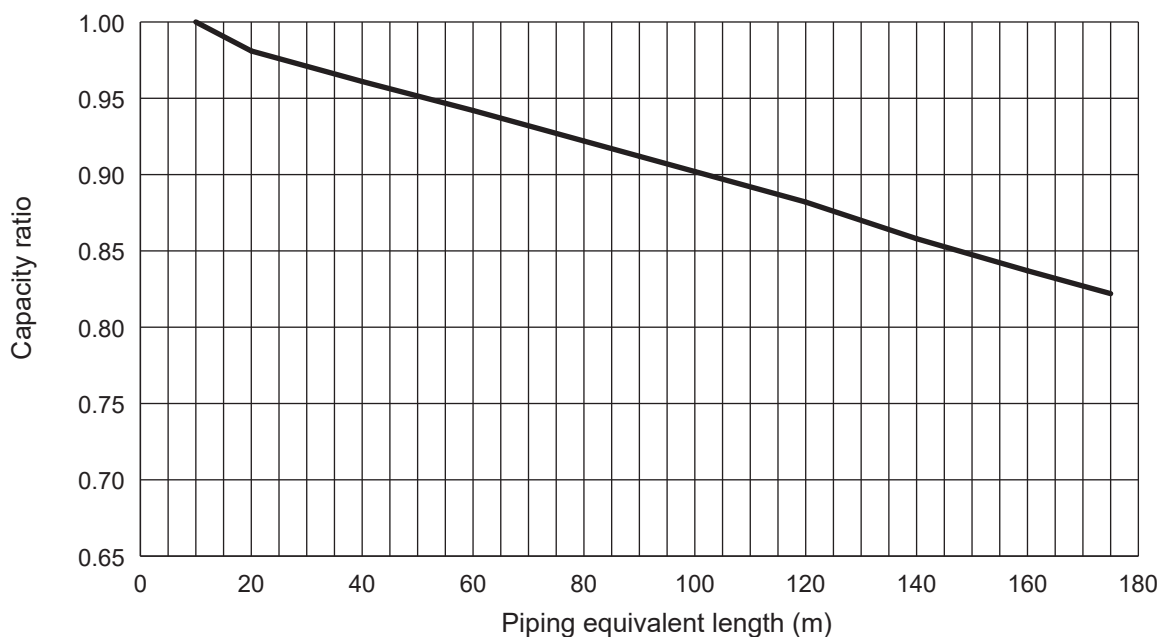

Figure 13 PUMY-P300YBM2

<Cooling>

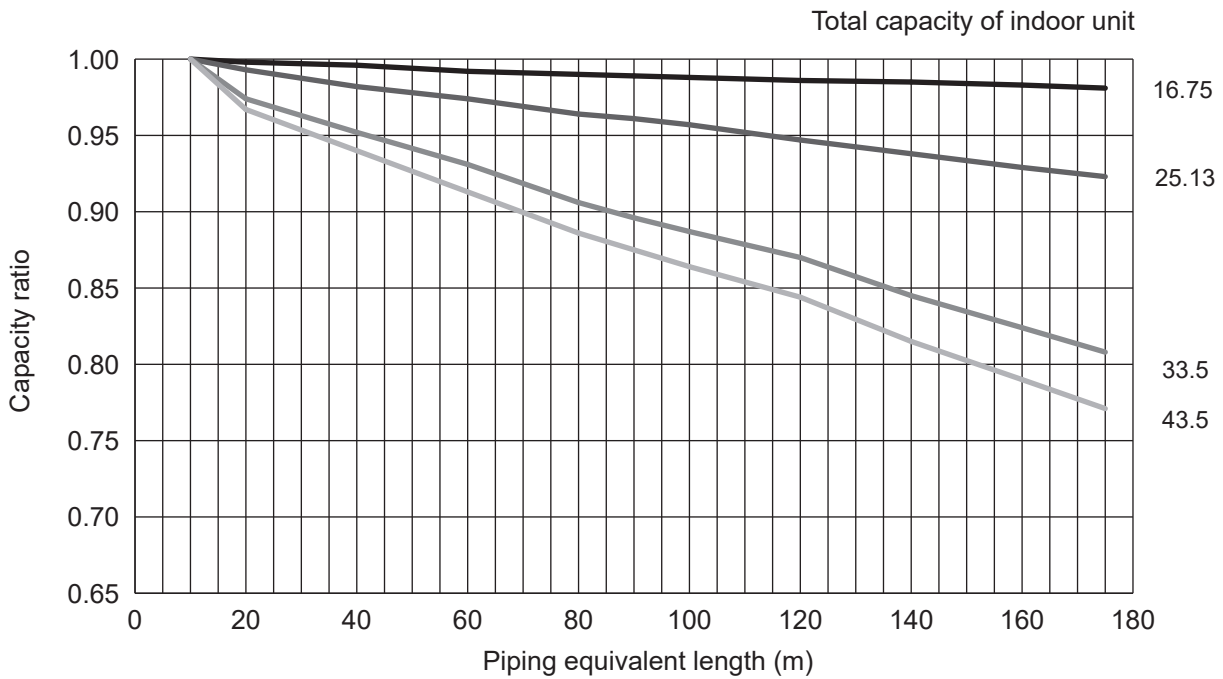
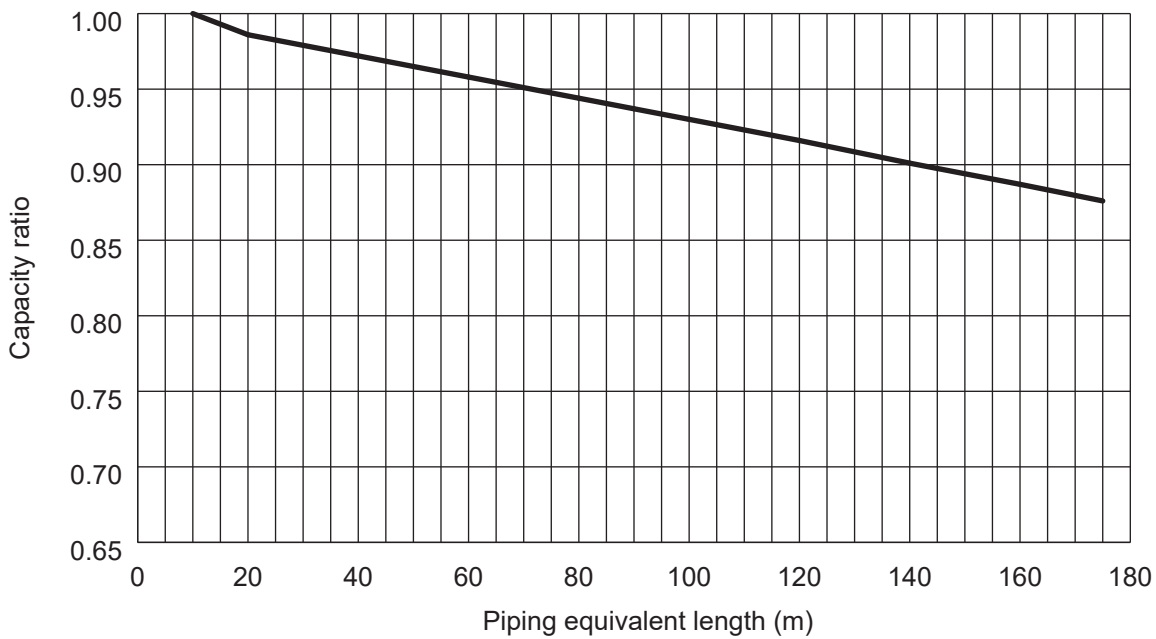

Figure 14 PUMY-P300YBM2

<Heating>



(2) Method for Obtaining the Equivalent Piping Length

Equivalent length = (length of piping to farthest indoor unit) + (0.3 × number of bends in the piping) (m)

4-4-1. Correction of Heating Capacity for Frost and Defrosting

If heating capacity has been reduced due to frost formation or defrosting, multiply the capacity by the appropriate correction factor from the following table to obtain the actual heating capacity.

Correction factor diagram

Outdoor Intake temperature (°C W.B.)	6	4	2	0	-2	-4	-6	-8	-10	-15	-20
Correction factor	1.00	0.98	0.89	0.88	0.89	0.90	0.95	0.95	0.95	0.95	0.95

4-5. NOISE CRITERION CURVES

PUMY-P250YBM2

MODE	SPL(dB)	LINE
COOLING	55	○—○
HEATING	61	●—●

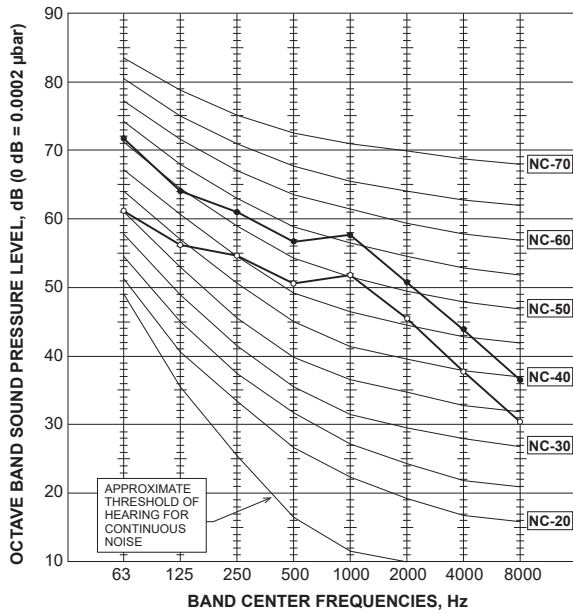

PUMY-P300YBM2

MODE	SPL(dB)	LINE
COOLING	57	○—○
HEATING	62	●—●

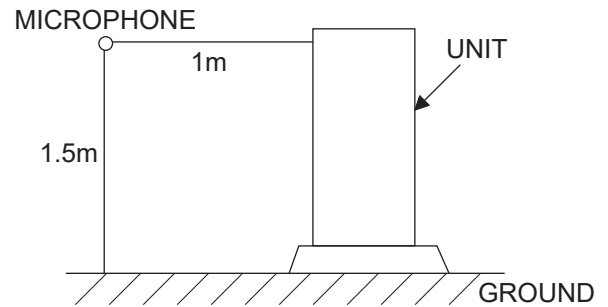
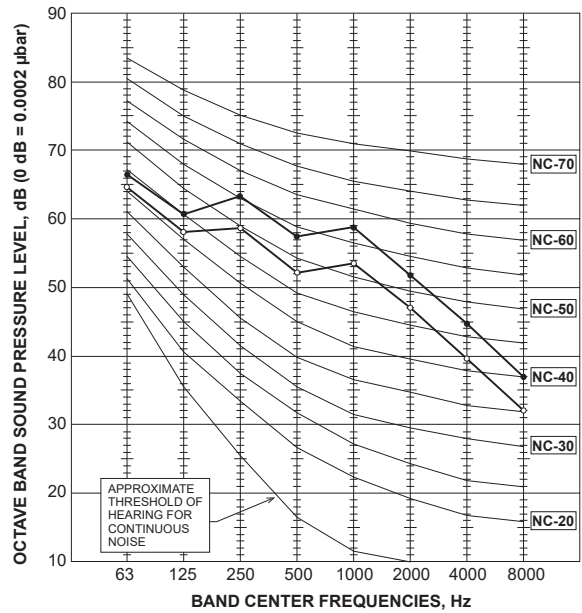

4-6. STANDARD OPERATION DATA (REFERENCE DATA)

Operation				PUMY-P250YBM2		PUMY-P300YBM2	
	Ambient temperature	Indoor	DB/WB	27°C/19°C	20°C/—	27°C/19°C	20°C/—
		Outdoor		35°C/24°C	7°C/6°C	35°C/24°C	7°C/6°C
Operating conditions	Indoor unit	No. of connected units	Unit	4		5	
		No. of units in operation		4		5	
	Piping	Model	m	63 x 4		63 x 4 + 50 x 1	
		Main pipe		5		5	
		Branch pipe		5		5	
Total pipe length	25		30				
Fan speed		—	Hi		Hi		
Amount of refrigerant		kg	13.6		14.9		
Outdoor unit	Electric current	A	12.85	12.30	18.99	14.59	
	Voltage	V	380		380		
	Compressor frequency	Hz	63	76	82	87	
Pressure	High pressure/Low pressure	MPa	3.09/0.98	2.30/0.60	3.40/0.90	2.30/0.61	
Temp. of each section	Outdoor unit	Discharge	°C	72.3	57.9	81.8	62.4
		Heat exchanger outlet		38.9	7.1	40.4	5.9
		Accumulator inlet		9.9	-1.1	8.4	-2.2
		Compressor inlet		12.0	-1.7	9.3	-3.0
	Indoor unit	LEV inlet		26.0	24.8	31.8	20.9
		Heat exchanger inlet		13.2	31.1	13.3	25.6

Unit: mm

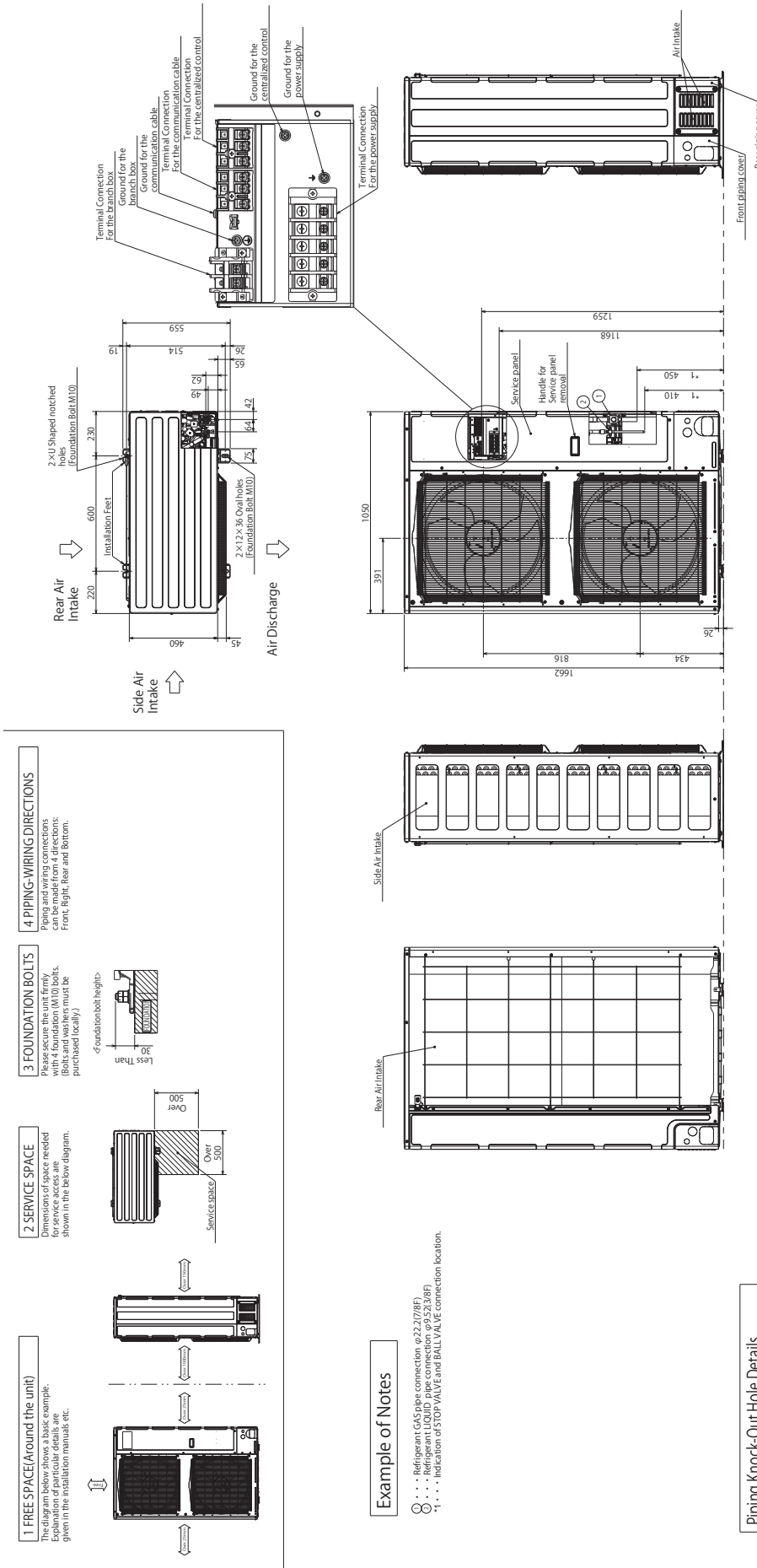

Piping Knock-Out Hole Details

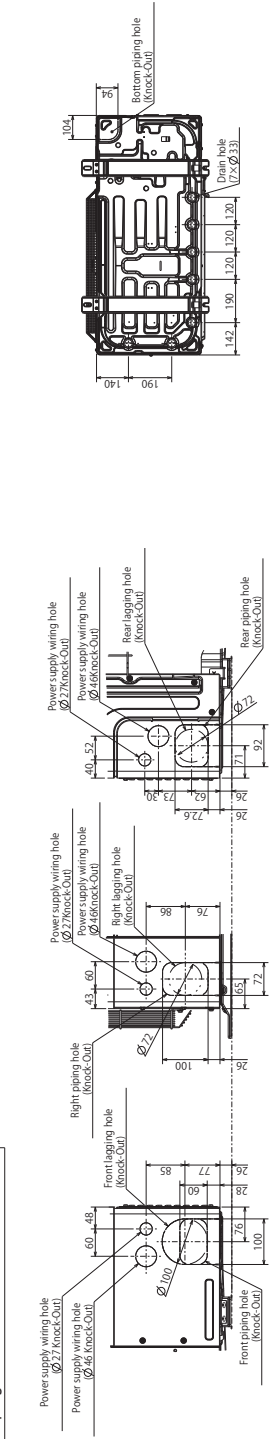

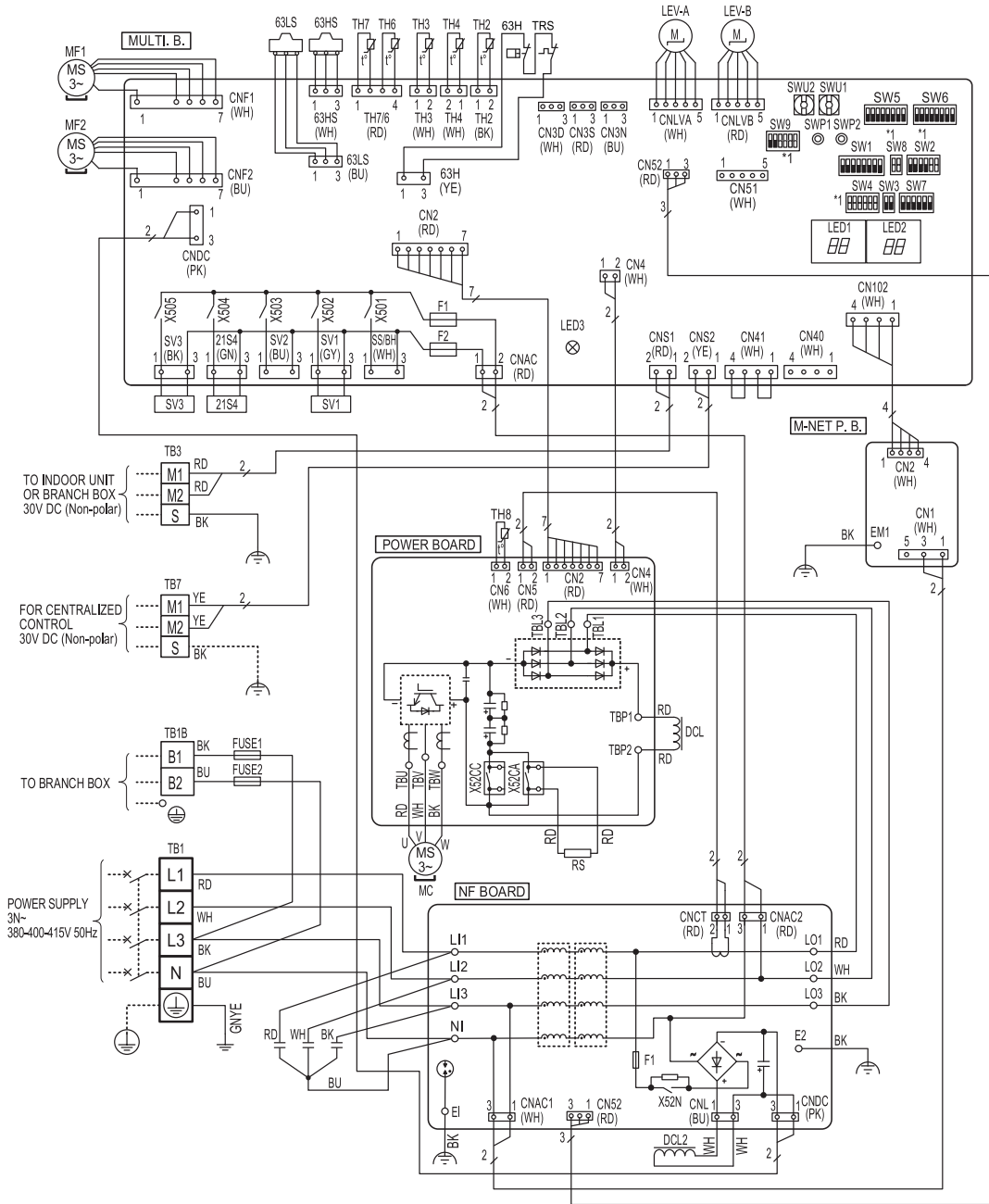

*1 MODEL SELECT
The black square (■) indicates a switch position.

MODELS	SW2	SW4	SW8	SW9
PUMY-P250YBM2	ON OFF ■ 5 6	ON OFF ■ 1 2 3 4 5 6	ON OFF ■ 1 2	ON OFF ■ 3 4 5 6
PUMY-P300YBM2	ON OFF ■ 5 6	ON OFF ■ 1 2 3 4 5 6	ON OFF ■ 1 2	ON OFF ■ 3 4 5 6

[LEGEND]

SYMBOL	NAME	SYMBOL	NAME	SYMBOL	NAME
TB1	Terminal Block <Power Supply>	TRS	Compressor protector	SW4	Switch <Model Selection>
TB1B	Terminal Block <Branch Box>	RS	Rush Current Protect Resistor	SW5	Switch <Function Selection>
TB3	Terminal Block <Branch Box/Outdoor Transmission Line>	LEV-A, LEV-B	Linear Expansion Valve	SW6	Switch <Function Selection>
TB7	Terminal Block <Centralized Control Transmission Line>	DCL	Reactor	SW7	Switch <Function Selection>
FUSE1, FUSE2	Fuse <T20AL250V>	DCL2	Reactor	SW8	Switch <Model Selection>
MC	Motor for Compressor	POWER BOARD	Power Circuit Board	SW9	Switch <Function/Model Selection>
MF1, MF2	Fan Motor	TB1, TB2, TB3	Connection Terminal <L1/L2/L3-Power Supply>	SWP1	Switch <Display Selection>
63H	High Pressure Switch	TBP1, TBP2	Connection Terminal <Reactor>	SWP2	Switch <Display Selection>
63HS	High Pressure Sensor	TBU, TBV, TBW	Connection Terminal <U/V/W-Phase>	SWU1	Switch <Unit Address Selection, ones digit>
63LS	Low Pressure Sensor	X52CA, X52CC	Relay with Connection Terminal	SWU2	Switch <Unit Address Selection, tens digit>
SV1	Solenoid Valve Coil <Bypass Valve>	NF BOARD	Noise Filter Circuit Board	SS/BH	Connector <Connection for Option>
SV3	Solenoid Valve Coil <Oil return Valve>	LH1, LH2, LH3, NI	Connection Terminal <L1/L2/L3/N-Power Supply>	CN3D	Connector <Connection for Option>
21S4	Solenoid Valve Coil <4-Way Valve>	LO1, LO2, LO3	Connection Terminal <L1/L2/L3-Power Supply>	CN3S	Connector <Connection for Option>
TH2	Thermistor <HC Pipe>	E1, E2	Connection Terminal <Electrical Parts Box>	CN3N	Connector <Connection for Option>
TH3	Thermistor <Outdoor Liquid Pipe>	F1	Fuse <T10AL250V>	CN51	Connector <Connection for Option>
TH4	Thermistor <Compressor>	MULTI.B.	Multi Controller Circuit Board	LED1, LED2	LED <Operation Inspection Display>
TH6	Thermistor <Suction Pipe>	SW1	Switch <Display Selection>	LED3	LED <Power Supply to Main Microcomputer>
TH7	Thermistor <Ambient>	SW2	Switch <Function/Model Selection>	F1, F2	Fuse <T6.3AL250V>
TH8	Thermistor <Heat Sink>	SW3	Switch <Test Run>	M-NET P.B.	M-NET Power Circuit Board
				EM1	Connection Terminal <Electrical Parts Box>

7-2. REFRIGERANT SYSTEM DIAGRAM

7-2-1. Connection without Branch box

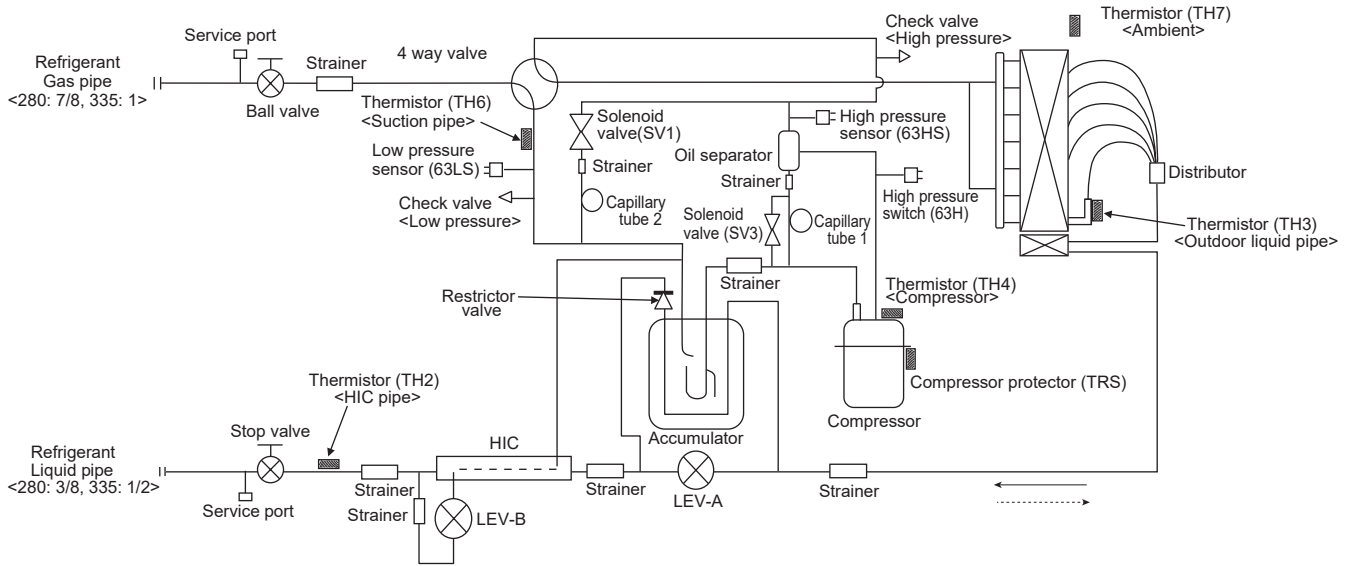

Unit: mm

Outdoor unit	Capillary tube 1	Capillary tube 2
PUMY-P250/300YBM2	ø2.4×ø0.8×L600	ø4.0×ø3.0×L220

Refrigerant piping specifications <dimensions of flared connector>

Unit: mm <in>

Capacity		Item	Liquid piping	Gas piping
Indoor unit	P15, 20, 25, 32, 40, 50		ø6.35 <1/4>	ø12.7 <1/2>
	P63, 80, 100, 125, 140		ø9.52 <3/8>	ø15.88 <5/8>
	P200		ø9.52 <3/8>	ø19.05 <3/4>
	P250		ø9.52 <3/8>	ø22.2 <7/8>
Outdoor unit	P250		ø9.52 <3/8> *	ø22.2 <7/8>
	P300		ø12.7 <1/2>	ø22.2 <7/8>

* Use ø12.7 when the farthest piping length is longer than 90 m or PEFY-P200 or/and 250 is/are connected.

Note:

When connecting the CONNECTION KIT (PAC-LV11M-J) and an M-series indoor unit, refer to the installation manual for the CONNECTION KIT.

7-2-2. Connection with Branch box

In case of using 1-branch box

Flare connection employed. (No. brazing)

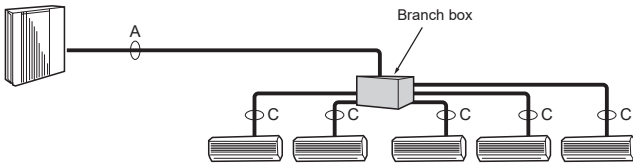

In case of using 2-branch boxes

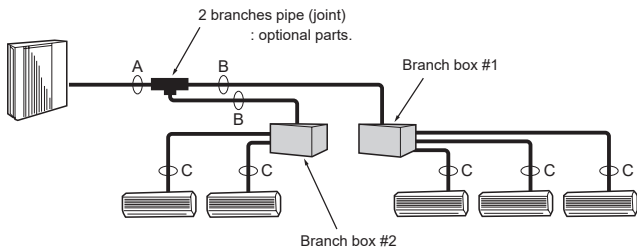

In case of using 3-branch boxes

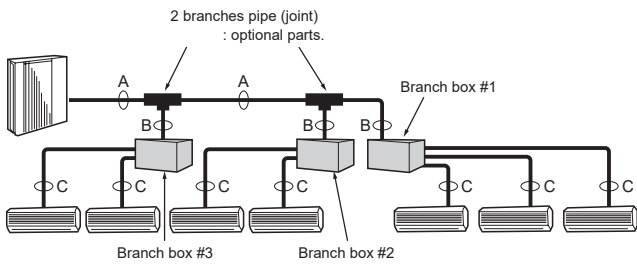

Fig. 7-1

(1) Valve size of branch box for outdoor unit

For liquid	ø9.52 mm
For gas	ø15.88 mm

(2) Valve size of branch box for indoor unit

UNIT	Pipe type	Valve size (mm)
A UNIT	Liquid pipe	ø6.35 mm
	Gas pipe	ø9.52 mm
B UNIT	Liquid pipe	ø6.35 mm
	Gas pipe	ø9.52 mm
C UNIT	Liquid pipe	ø6.35 mm
	Gas pipe	ø9.52 mm
D UNIT	Liquid pipe	ø6.35 mm
	Gas pipe	ø9.52 mm
E UNIT	Liquid pipe	ø6.35 mm
	Gas pipe	ø12.7 mm

* 3-branch type : only A, B, C unit

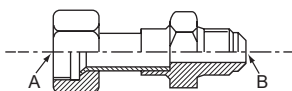

Fig. 7-2

Conversion formula

1/4 F	ø6.35
3/8 F	ø9.52
1/2 F	ø12.7
5/8 F	ø15.88
3/4 F	ø19.05
7/8 F	ø22.2
1 F	ø25.4

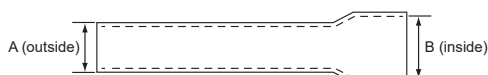

Fig. 7-3

Selecting pipe size (Fig. 7-1)

A

Model	Liquid pipe	Gas pipe
P250	ø9.52	ø22.2
P300	ø12.7	ø22.2

B

Total down-stream capacity of indoor units	Model	Liquid pipe	Gas pipe
- 16.0 kW	P250	ø9.52	ø15.88
	P300	ø12.7	
16.1 kW - 22.4 kW	P250	ø9.52	ø19.05
	P300	ø12.7	
22.5 kW -	P250	ø9.52	ø22.2
	P300	ø12.7	

C

The piping connection size differs according to the type and capacity of indoor units. Match the piping connection size of branch box with indoor unit.

If the piping connection size of branch box does not match the piping connection size of indoor unit, use optional different-diameter (deformed) joints to the branch box side.
(Connect deformed joint directly to the branch box side.)

Different-diameter joint (optional parts) (Fig. 7-2, 7-3)

Model name	Connected pipes diameter	Diameter A	Diameter B
	mm	mm	mm
MAC-A454JP	ø9.52 → ø12.7	ø9.52	ø12.7
MAC-A455JP	ø12.7 → ø9.52	ø12.7	ø9.52
MAC-A456JP	ø12.7 → ø15.88	ø12.7	ø15.88
PAC-493PI	ø6.35 → ø9.52	ø6.35	ø9.52
PAC-SG76RJ-E	ø9.52 → ø15.88	ø9.52	ø15.88
PAC-SG75RJ-E	ø15.88 → ø19.05	ø15.88	ø19.05
PAC-SG71RJ-E	ø15.88 *1 → ø22.2 *2	ø15.88 *1	ø22.2 *2

*1 When connecting to MSDD-50AR-E or a branch box, flare the pipes on-site.

Use the nuts that are included with the 2-branch pipe and branch box.

*2 Brazing

2 branch pipe (Joint) : Optional parts (According to the connection method, you can choose the favorite one.)

Model name	Connection method
MSDD-50AR-E	flare
MSDD-50BR-E	brazing

Installation procedure (2 branches pipe (Joint))

Refer to the installation manuals of MSDD-50AR-E and MSDD-50BR-E.

The lineup of a connectable indoor unit depends on the district/area/country.

Pipe size (Branch box-Indoor unit) *Case of M, S, P series Indoor unit

Indoor unit type	(kW)	15	20	22	25	35	42	50
Pipe size (mm)	Liquid	ø6.35	ø6.35	ø6.35	ø6.35	ø6.35	ø6.35	ø6.35
	Gas	ø9.52	ø9.52	ø9.52	ø9.52	ø9.52	ø9.52	ø12.7

7-2-3. Mixed system (CITY MULTI indoor units and M series indoor units [Via Branch box])

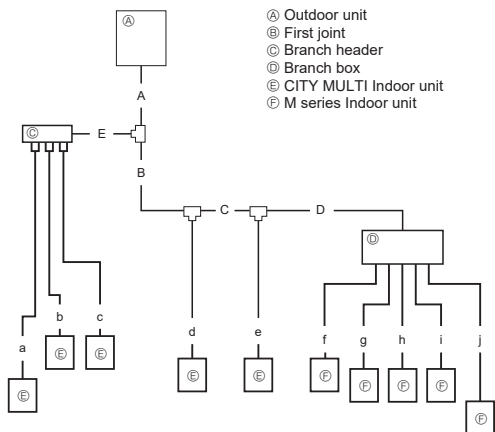

Fig. 7-4

Branch box pipe size

(1) Valve size of branch box for outdoor unit

For liquid	ø9.52 mm
For gas	ø15.88 mm

(2) Valve size of branch box for indoor unit

UNIT		
A UNIT	Liquid pipe	ø6.35 mm
	Gas pipe	ø9.52 mm
B UNIT	Liquid pipe	ø6.35 mm
	Gas pipe	ø9.52 mm
C UNIT	Liquid pipe	ø6.35 mm
	Gas pipe	ø9.52 mm
D UNIT	Liquid pipe	ø6.35 mm
	Gas pipe	ø9.52 mm
E UNIT	Liquid pipe	ø6.35 mm
	Gas pipe	ø12.7 mm

* 3-branch type : only A, B, C unit

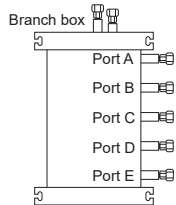

A

Model	Liquid pipe	Gas pipe
P250	ø9.52*	ø22.2
P300	ø12.7	ø22.2

B, C, D, E

Total down-stream capacity of indoor units	Model	Liquid pipe	Gas pipe
- 16.0 kW	P250	ø9.52*	ø15.88
	P300	ø12.7	
16.1 kW - 22.4 kW	P250	ø9.52*	ø19.05
	P300	ø12.7	
22.5 kW -	P250	ø9.52*	ø22.2
	P300	ø12.7	

* ø12.7 when connecting the indoor unit for PEFY-P200 or P250

a, b, c - j

Indoor unit series	Model number		Liquid pipe	Gas pipe
	kW	cal		
City Multi	- 50	-	ø6.35	ø12.7
	63 - 140	-		
	200	-	ø9.52	ø19.05
	250	-		
M series	- 35	- 32	ø6.35	ø9.52
	50	-		
	-	50	ø9.52	ø15.88
	60 -	63 -		
S series	- 35	-	ø6.35	ø9.52
	50 - 60	-		
	-	-	ø9.52	ø15.88
	71 -	-		

2-branch joint	CMY-Y62-G-E
4-branch header	CMY-Y64-G-E
8-branch header	CMY-Y68-G-E

Different-diameter joint (optional parts) (Fig. 7-2, 7-3)

Model name	Connected pipes diameter	Diameter A	Diameter B
	mm	mm	mm
MAC-A454JP	ø9.52 → ø12.7	ø9.52	ø12.7
MAC-A455JP	ø12.7 → ø9.52	ø12.7	ø9.52
MAC-A456JP	ø12.7 → ø15.88	ø12.7	ø15.88
PAC-493PI	ø6.35 → ø9.52	ø6.35	ø9.52
PAC-SG76RJ-E	ø9.52 → ø15.88	ø9.52	ø15.88
PAC-SG75RJ-E	ø15.88 → ø19.05	ø15.88	ø19.05
PAC-SG71RJ-E	ø15.88 *1 → ø22.2 *2	ø15.88 *1	ø22.2 *2

*1 When connecting to MSDD-50AR-E or a branch box, flare the pipes on-site.

Use the nuts that are included with the 2-branch pipe and branch box.

*2 Brazing

2 branch pipe (Joint) : Optional parts (According to the connection method, you can choose the favorite one.)

Model name	Connection method
MSDD-50AR-E	flare
MSDD-50BR-E	brazing

7-3. SYSTEM CONTROL

7-3-1. Example for the System

• Example for wiring control cables, wiring method and address setting, permissible lengths, and the constraint items are listed in the standard system with detailed explanation.

A. Example of an M-NET remote controller system (address setting is necessary.)

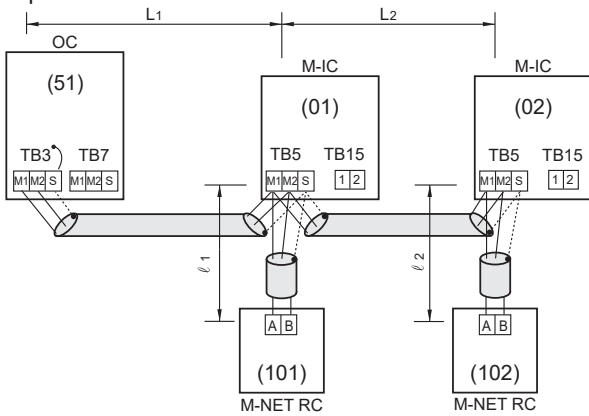
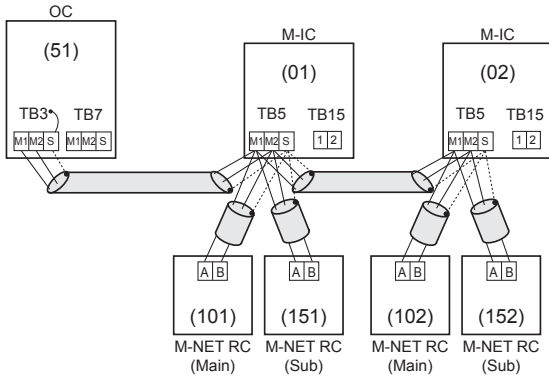
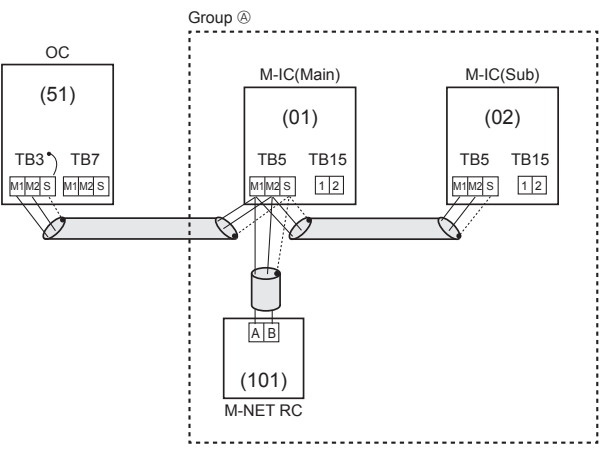
Example of wiring control cables	Wiring Method and Address Setting															
<p>1. Standard operation</p>  <ul style="list-style-type: none"> • 1 M-NET remote controller for each CITY MULTI series indoor unit • There is no need for setting the 100 position on the M-NET remote controller. 	<p>a. Use feed wiring to connect terminals M1 and M2 on transmission cable block (TB3) for the outdoor unit (OC) to terminals M1 and M2 on the transmission cable block (TB5) of each CITY MULTI series indoor unit (M-IC). Use non-polarized 2-core wire.</p> <p>b. Connect terminals M1 and M2 on transmission cable terminal block (TB5) for each indoor unit with the terminal block (TB6) for M-NET the remote controller (M-NET RC).</p> <p>c. Set the address setting switch (on outdoor unit P.C.B) as shown below.</p> <table border="1" data-bbox="837 772 1447 985"> <thead> <tr> <th>Unit</th> <th>Range</th> <th>Setting Method</th> </tr> </thead> <tbody> <tr> <td>CITY MULTI series indoor unit (M-IC)</td> <td>001 to 050</td> <td>—</td> </tr> <tr> <td>Outdoor unit (OC)</td> <td>051 to 100</td> <td>Use the smallest address of all the indoor unit plus 50.</td> </tr> <tr> <td>M-NET Remote controller (M-NET RC)</td> <td>101 to 150</td> <td>Indoor unit address plus 100</td> </tr> </tbody> </table>	Unit	Range	Setting Method	CITY MULTI series indoor unit (M-IC)	001 to 050	—	Outdoor unit (OC)	051 to 100	Use the smallest address of all the indoor unit plus 50.	M-NET Remote controller (M-NET RC)	101 to 150	Indoor unit address plus 100			
Unit	Range	Setting Method														
CITY MULTI series indoor unit (M-IC)	001 to 050	—														
Outdoor unit (OC)	051 to 100	Use the smallest address of all the indoor unit plus 50.														
M-NET Remote controller (M-NET RC)	101 to 150	Indoor unit address plus 100														
<p>2. Operation using 2 M-NET remote controllers</p>  <ul style="list-style-type: none"> • Using 2 M-NET remote controllers for each CITY MULTI series indoor unit. 	<p>a. Same as above 1.a</p> <p>b. Same as above 1.b</p> <p>c. Set address switch (on outdoor unit P.C.B) as shown below.</p> <table border="1" data-bbox="837 1108 1447 1411"> <thead> <tr> <th>Unit</th> <th>Range</th> <th>Setting Method</th> </tr> </thead> <tbody> <tr> <td>CITY MULTI series indoor unit (M-IC)</td> <td>001 to 050</td> <td>—</td> </tr> <tr> <td>Outdoor unit (OC)</td> <td>051 to 100</td> <td>Use the smallest address of all the indoor units plus 50.</td> </tr> <tr> <td>Main M-NET Remote Controller (M-NET RC)</td> <td>101 to 150</td> <td>Indoor unit address plus 100</td> </tr> <tr> <td>Sub M-NET Remote Controller (M-NET RC)</td> <td>151 to 200</td> <td>Indoor unit address plus 150</td> </tr> </tbody> </table>	Unit	Range	Setting Method	CITY MULTI series indoor unit (M-IC)	001 to 050	—	Outdoor unit (OC)	051 to 100	Use the smallest address of all the indoor units plus 50.	Main M-NET Remote Controller (M-NET RC)	101 to 150	Indoor unit address plus 100	Sub M-NET Remote Controller (M-NET RC)	151 to 200	Indoor unit address plus 150
Unit	Range	Setting Method														
CITY MULTI series indoor unit (M-IC)	001 to 050	—														
Outdoor unit (OC)	051 to 100	Use the smallest address of all the indoor units plus 50.														
Main M-NET Remote Controller (M-NET RC)	101 to 150	Indoor unit address plus 100														
Sub M-NET Remote Controller (M-NET RC)	151 to 200	Indoor unit address plus 150														
<p>3. Group operation</p>  <ul style="list-style-type: none"> • Multiple CITY MULTI series indoor units operated together by 1 M-NET remote controller 	<p>a. Same as above 1.a</p> <p>b. Connect terminals M1 and M2 on transmission cable terminal block (TB5) of the M-IC main unit with the most recent address within the same CITY MULTI series indoor unit (M-IC) group to terminal block (TB6) on the M-NET remote controller.</p> <p>c. Set the address setting switch (on outdoor unit P.C.B) as shown below.</p> <table border="1" data-bbox="837 1668 1447 2004"> <thead> <tr> <th>Unit</th> <th>Range</th> <th>Setting Method</th> </tr> </thead> <tbody> <tr> <td>M-IC (Main)</td> <td>001 to 050</td> <td>Use the smallest address within the same group of CITY MULTI series indoor units.</td> </tr> <tr> <td>M-IC (Sub)</td> <td>001 to 050</td> <td>Use an address, other than that of the M-IC (Main) from among the units within the same group of indoor units. This must be in sequence with the M-IC (Main).</td> </tr> <tr> <td>Outdoor unit</td> <td>051 to 100</td> <td>Use the smallest address of all the CITY MULTI series indoor units plus 50.</td> </tr> <tr> <td>Main M-NET Remote Controller (M-NET RC)</td> <td>101 to 150</td> <td>Set at an M-IC (Main) address within the same group plus 100.</td> </tr> </tbody> </table> <p>d. Use the CITY MULTI series indoor unit (M-IC) within the group with the most functions as the M-IC (Main) unit.</p>	Unit	Range	Setting Method	M-IC (Main)	001 to 050	Use the smallest address within the same group of CITY MULTI series indoor units.	M-IC (Sub)	001 to 050	Use an address, other than that of the M-IC (Main) from among the units within the same group of indoor units. This must be in sequence with the M-IC (Main).	Outdoor unit	051 to 100	Use the smallest address of all the CITY MULTI series indoor units plus 50.	Main M-NET Remote Controller (M-NET RC)	101 to 150	Set at an M-IC (Main) address within the same group plus 100.
Unit	Range	Setting Method														
M-IC (Main)	001 to 050	Use the smallest address within the same group of CITY MULTI series indoor units.														
M-IC (Sub)	001 to 050	Use an address, other than that of the M-IC (Main) from among the units within the same group of indoor units. This must be in sequence with the M-IC (Main).														
Outdoor unit	051 to 100	Use the smallest address of all the CITY MULTI series indoor units plus 50.														
Main M-NET Remote Controller (M-NET RC)	101 to 150	Set at an M-IC (Main) address within the same group plus 100.														

Combinations of 1 through 3 above are possible.

• Name, Symbol and the Maximum Remote controller Units for Connection

Name	Symbol	Maximum units for connection
Outdoor unit	OC	—
CITY MULTI series Indoor unit	M-IC	Refer to "2-1. SYSTEM CONSTRUCTION".
M-NET remote controller	M-NET RC	Maximum 2 M-NET RC for 1 indoor unit, Maximum 12 M-NET RC for 1 OC

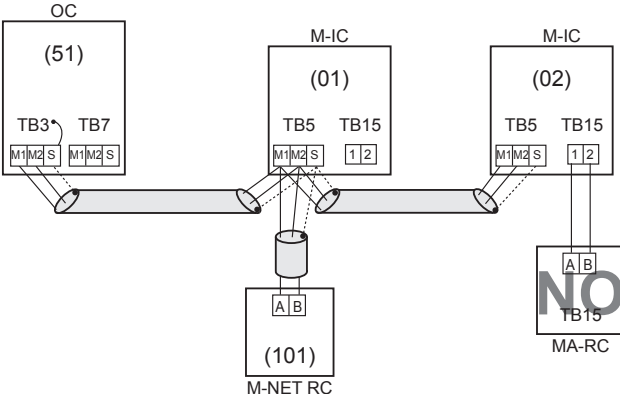
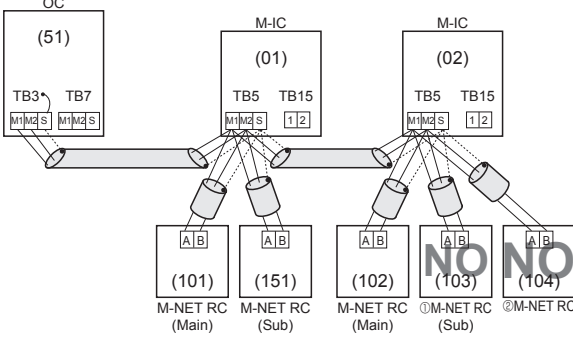
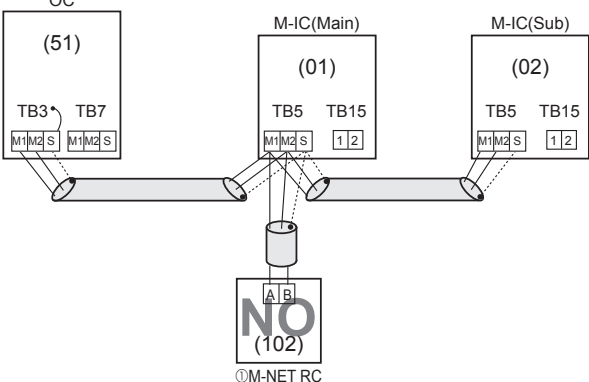
Permissible Lengths	Constraint items
<p>Indoor/outdoor transmission line Maximum distance (1.25 mm²) $L_1 + L_2 \leq 200$ m M-NET Remote controller cable length 1. If 0.5 to 1.25 mm² $l_1, l_2 \leq 10$ m 2. If the length exceeds 10 m, the exceeding section should be 1.25 mm² and that section should be a value within the total extension length of the transmission cable and maximum transmission cable length.</p>	<ul style="list-style-type: none"> M-NET remote controller (M-NET RC) and MA remote controller (MA RC) cannot be used together. Do not connect anything with TB15 of CITY MULTI series indoor unit (M-IC). 
Same as above	 <ul style="list-style-type: none"> ① Use the CITY MULTI series indoor unit (M-IC) address plus 150 as the sub M-NET remote controller address. In this case, it should be 152. ② 3 or more M-NET remote controllers (M-NET RC) cannot be connected to 1 CITY MULTI series indoor unit.
Same as above	 <ul style="list-style-type: none"> ① The M-NET remote controller address is the CITY MULTI series indoor unit main address plus 100. In this case, it should be 101.

B. Example of a group operation system with 2 or more outdoor units and an M-NET remote controller.
(Address settings are necessary.)

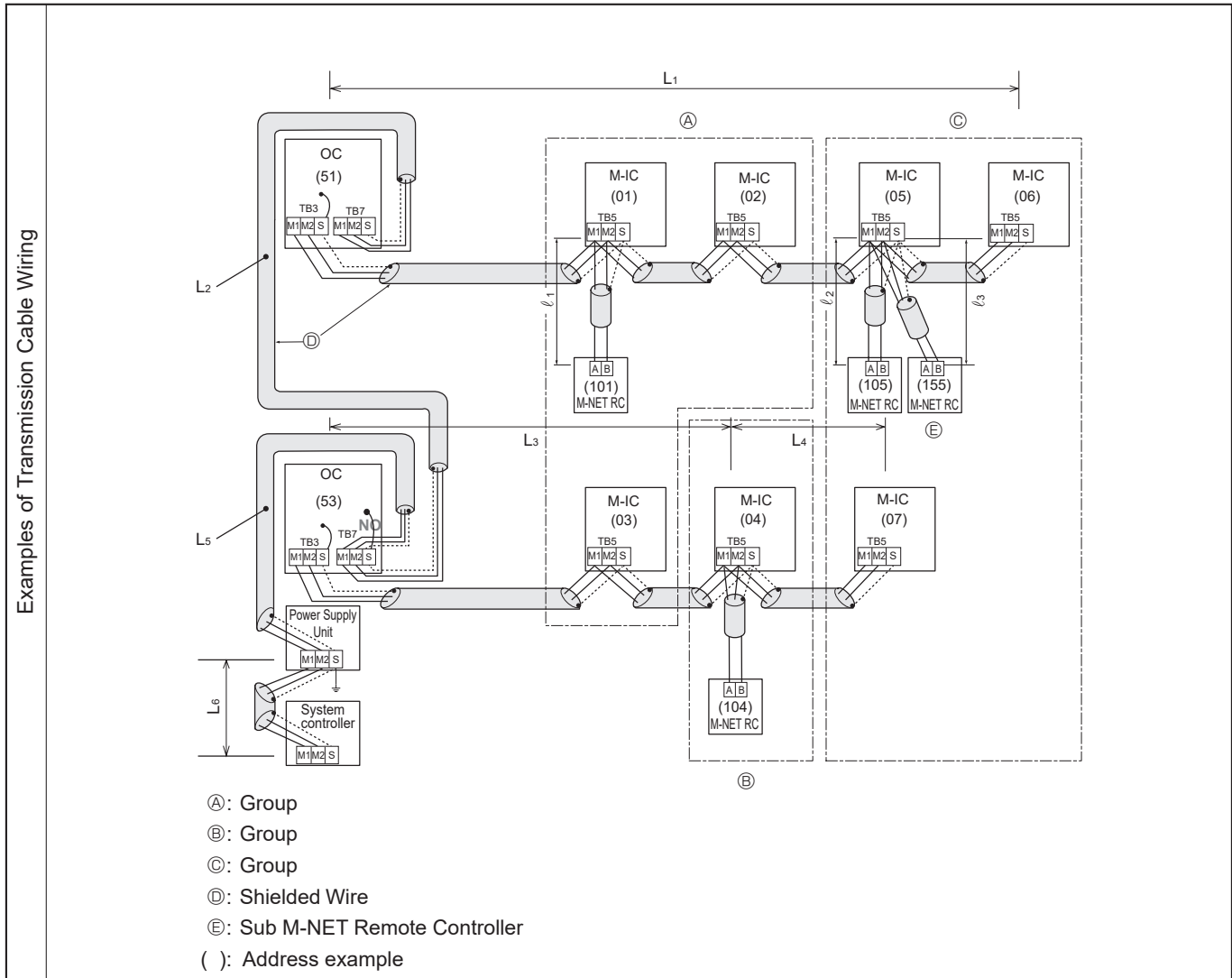

- Wiring Method Address Settings
- Always use shielded wire when making connections between the outdoor unit (OC) and the CITY MULTI series indoor unit (M-IC), as well as for all OC-OC, and IC-IC wiring intervals.
 - Use feed wiring to connect terminals M1 and M2 and the ground terminal on the transmission cable terminal block (TB3) of each outdoor unit (OC) to terminals M1 and M2 on the terminal S on the transmission cable terminal block of the CITY MULTI series indoor unit (M-IC).
 - Connect terminals M1 and M2 on the transmission cable terminal block of the CITY MULTI series indoor unit (M-IC) that has the most recent address within the same group to the terminal block on the M-NET remote controller (M-NET RC).
 - Connect together terminals M1, M2 and terminal S on the terminal block for centralized control (TB7) for the outdoor unit (OC).
 - DO NOT change the jumper connector CN41 on outdoor multi controller circuit board.
 - The earth processing of S terminal for the centralized control terminal block (TB7) is unnecessary. Connect the terminal S on the power supply unit with the earth.
 - Set the address setting switch as follows.

Unit	Range	Setting Method
M-IC (Main)	01 to 50	Use the smallest address within the same group of CITY MULTI series indoor units.
M-IC (Sub)	01 to 50	Use an address, other than the M-IC (Main) in the same group of CITY MULTI series indoor units. This must be in sequence with the M-IC (Main).
Outdoor Unit	51 to 100	Use the smallest address of all the CITY MULTI series indoor units plus 50. The address automatically becomes "100" if it is set as "01-50".
Main M-NET Remote Controller	101 to 150	Set at an M-IC (Main) address within the same group plus 100.
Sub M-NET Remote Controller	151 to 200	Set at an M-IC (Main) address within the same group plus 150.
MA Remote Controller	—	Address setting is not necessary. (Main/sub setting is necessary.)

- The group setting operations among the multiple CITY MULTI series indoor units are done by the M-NET remote controller (M-NET RC) after the electrical power has been turned on.

• Name, Symbol, and the Maximum Units for Connection

- Permissible Length**
- Maximum line distance via outdoor unit: $L_1+L_2+L_3+L_4, L_3+L_4+L_5+L_6, L_1+L_2+L_5+L_6 \leq 500$ meters (1.25 mm^2)
 - Indoor/outdoor transmission line Maximum distance: $L_1, L_3+L_4, L_2+L_5, L_6 \leq 200$ m (1.25 mm^2)
 - M-NET Remote controller cable length: $l_1, l_2+l_3 \leq 10$ m (0.5 to 1.25 mm^2)
 If the length exceeds 10 m, use a 1.25 mm^2 shielded wire.
 The section of the cable that exceeds 10 m must be included in the max length via outdoor units and max transmission cable length.

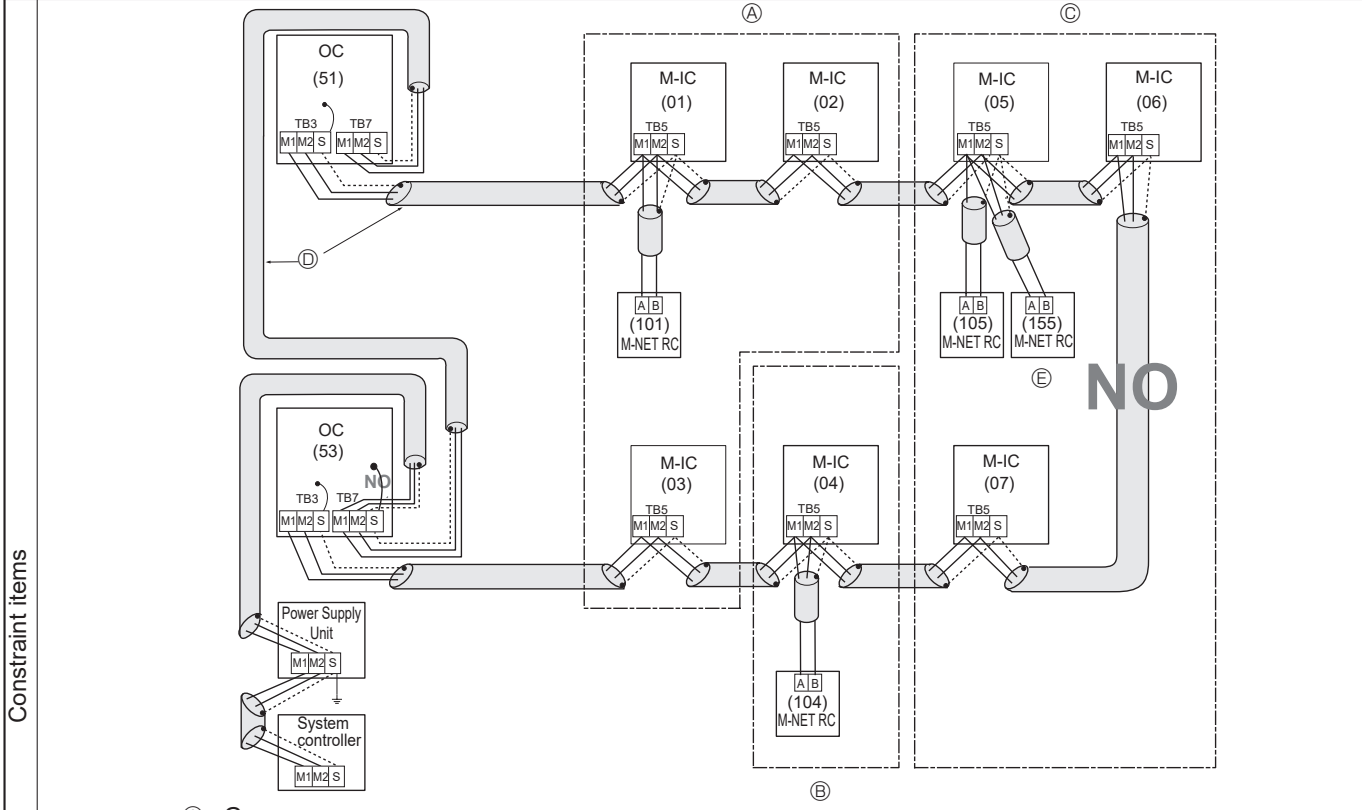

- Ⓐ : Group
- Ⓑ : Group
- Ⓒ : Group
- Ⓓ : Shielded Wire
- Ⓔ : Sub M-NET Remote Controller
- () : Address example

- Never connect together the terminal blocks (TB5) for transmission wires for CITY MULTI series indoor units (M-IC) that have been connected to different outdoor units (OC).
- Set all addresses to ensure that they are not overlapped.
- M-NET remote controller and MA remote controller cannot be connected with the CITY MULTI series indoor unit of the same group wiring together.

C. Example of an MA remote controller system (address setting is not necessary.)

NOTE: In the case of same group operation, need to set the address that is only main CITY MULTI series indoor unit.

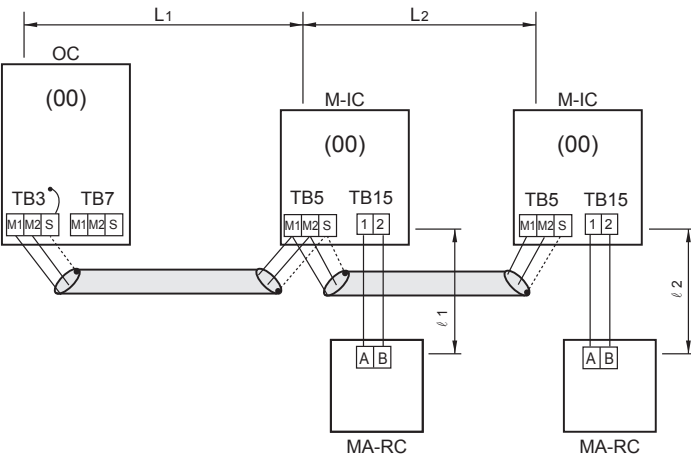
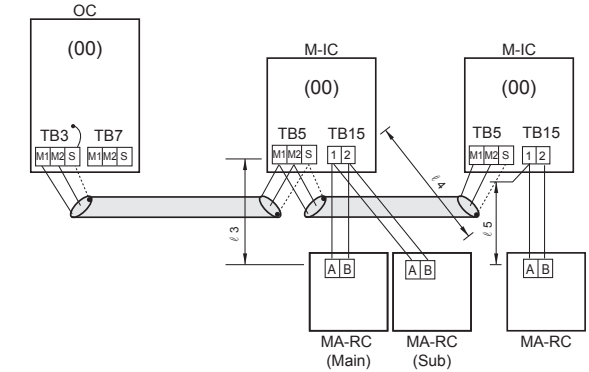
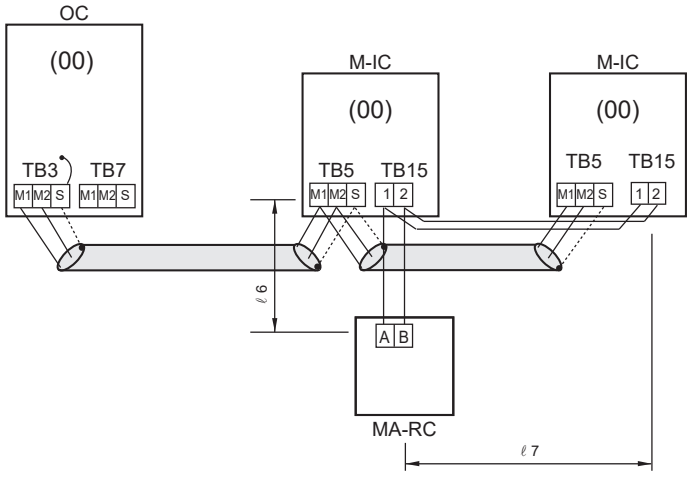
Example of wiring control cables	Wiring Method and Address Setting
<p>1. Standard operation</p>  <p>• 1 MA remote controller for each indoor unit.</p>	<p>a. Use feed wiring to connect terminals M1 and M2 on transmission cable block (TB3) for the outdoor unit (OC) to terminals M1 and M2 on the transmission cable block (TB5) of each CITY MULTI series indoor unit (M-IC). Use non-polarized 2-core wire.</p> <p>b. Connect terminals 1 and 2 on transmission cable terminal block (TB15) for each CITY MULTI series indoor unit with the terminal block for the MA remote controller (MA-RC).</p>
<p>2. Operation using 2 remote controllers</p>  <p>• Using 2 MA remote controllers for each CITY MULTI series indoor unit.</p>	<p>a. The same as above 1.a</p> <p>b. The same as above 1.b</p> <p>c. In the case of using 2 remote controllers, connect terminals 1 and 2 on transmission cable terminal block (TB15) for each indoor unit with the terminal block for 2 MA remote controllers.</p> <p>· Set either one of the MA remote controllers to "sub remote controller". Refer to the installation manual of MA remote controller.</p>
<p>3. Group operation</p>  <p>• Multiple indoor units operated together by 1 MA remote controller.</p>	<p>a. The same as above 1.a</p> <p>b. The same as above 1.b</p> <p>c. In the case of group operation using MA remote controller (MA-RC), connect terminals 1 and 2 on transmission cable terminal block (TB15) of each CITY MULTI series indoor unit. Use non-polarized 2-core wire.</p> <p>d. In the case of same group operation, need to set the address that is only main CITY MULTI series indoor unit. Please set the smallest address within number 01–50 of the CITY MULTI series indoor unit with the most functions in the same group.</p>
<p>Combinations of 1 through 3 above are possible.</p>	

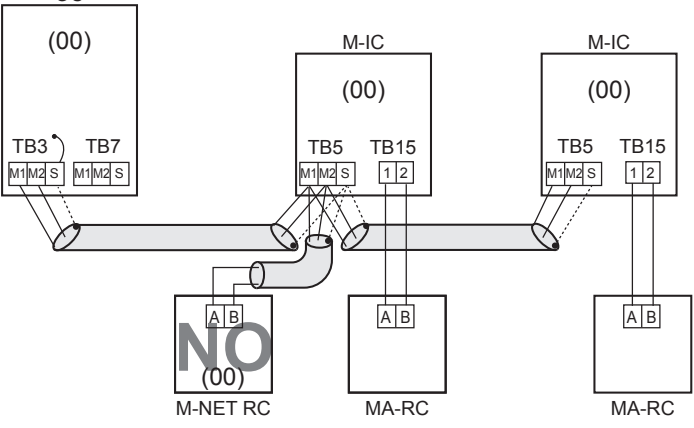
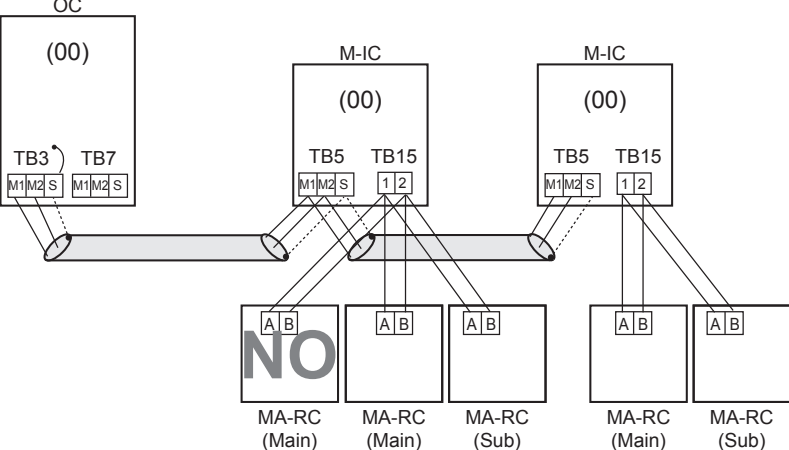
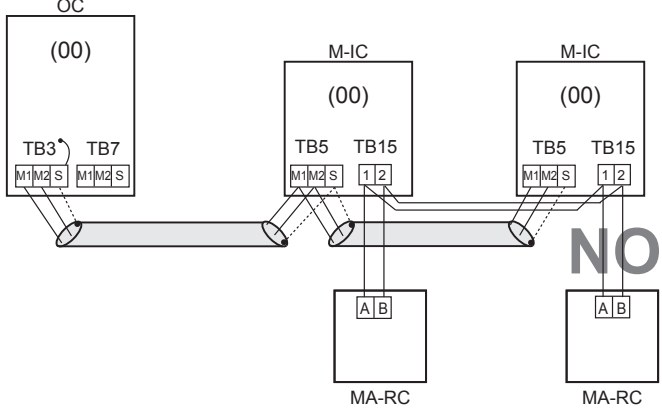
Permissible Lengths	Constraint items
<p>Indoor/outdoor transmission line Maximum distance: $L_1 + L_2 \leq 200 \text{ m}$ (1.25 mm²) MA remote controller cable length: $l_1, l_2 \leq 200 \text{ m}$ (0.3 to 1.25 mm²)</p>	<p>The MA remote controller and the M-NET remote controller cannot be used together with the CITY MULTI series indoor unit of the same group. M-NET remote controller cannot be connected without address setting.</p> 
<p>Indoor/outdoor transmission line Maximum distance: $L_1 + L_2 \leq 200 \text{ m}$ (1.25 mm²) MA remote controller cable length: $l_3 + l_4, l_5 \leq 200 \text{ m}$ (0.3 to 1.25 mm²)</p>	<p>3 MA remote controllers or more cannot be connected with the CITY MULTI series indoor unit of the same group.</p> 
<p>Indoor/outdoor transmission line Maximum distance: $L_1 + L_2 \leq 200 \text{ m}$ (1.25 mm²) MA remote controller cable length: $l_6 + l_7 \leq 200 \text{ m}$ (0.3 to 1.25 mm²)</p>	<p>The second MA remote controller is connected with the terminal block (TB15) for the MA remote controller of the same CITY MULTI series indoor unit (M-IC) as the first MA remote control.</p> 

D. Example of a group operation with 2 or more outdoor units and an MA remote controller.
 (Address settings are necessary.)

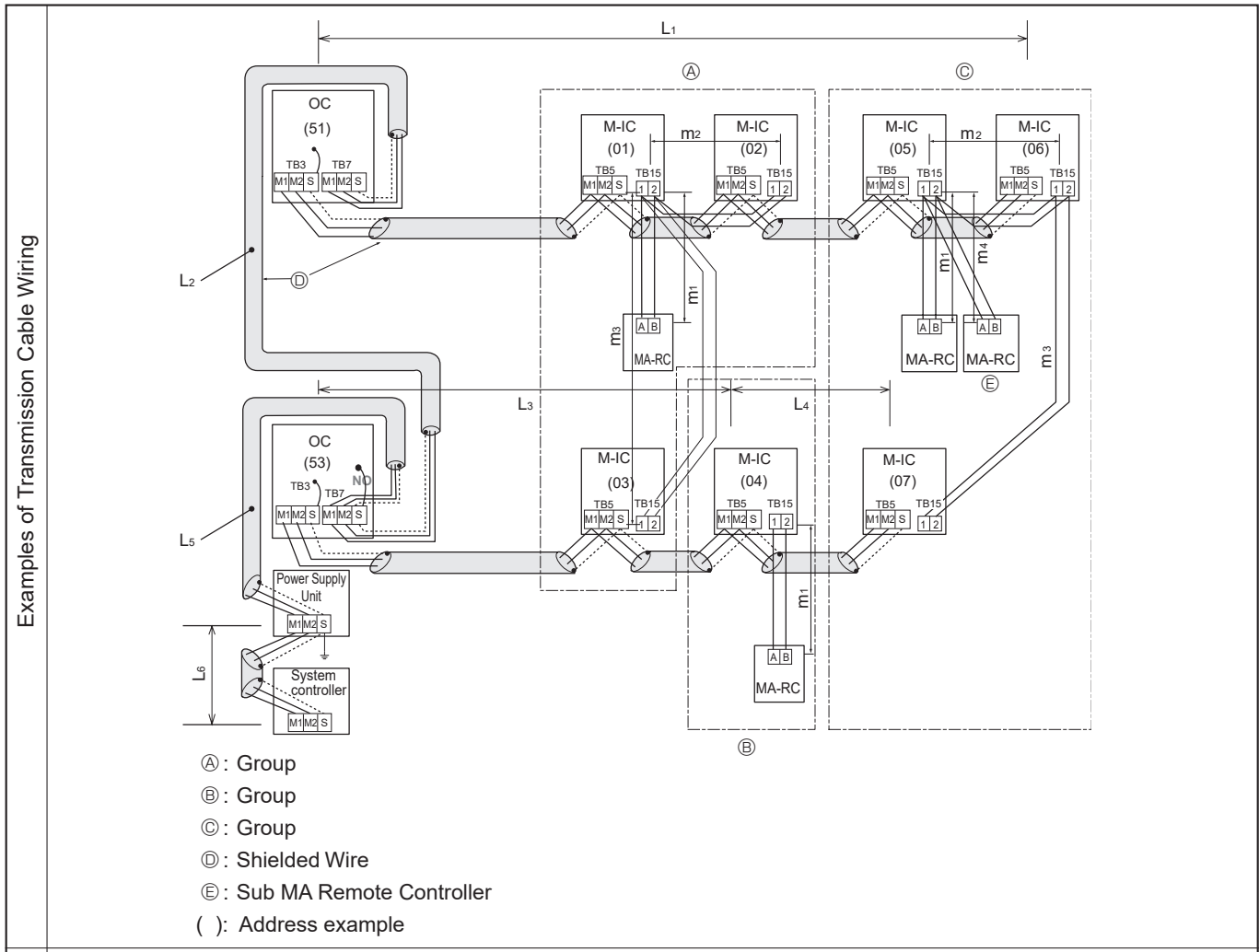

- Wiring Method Address Settings
- Always use shielded wire when making connections between the outdoor unit (OC) and the CITY MULTI series indoor unit (M-IC), as well for all OC-OC, and IC-IC wiring intervals.
 - Use feed wiring to connect terminals M1 and M2 and the ground terminal on the transmission cable terminal block (TB3) of each outdoor unit (OC) to terminals M1 and M2 on the terminal S on the transmission cable terminal block of the CITY MULTI series indoor unit (M-IC).
 - Connect terminals 1 and 2 on the terminal block for MA remote controller line (TB15) on the indoor unit (IC) to the terminal block on the MA remote controller (MA-RC). (Nonpolarized two-wire)
 - Connect together terminals M1, M2 and terminal S on the terminal block for centralized control (TB7) for the outdoor unit (OC).
 - DO NOT change the jumper connector CN41 on outdoor multi controller circuit board.
 - The earth processing of S terminal for the centralized control terminal block (TB7) is unnecessary. Connect the terminal S on the power supply unit with the earth.
 - Set the address setting switch as follows.

Unit	Range	Setting Method
M-IC (Main)	01 to 50	Use the smallest address within the same group of indoor units.
M-IC (Sub)	01 to 50	Use an address, other than the M-IC (Main) in the same group of CITY MULTI series indoor units. This must be in sequence with the M-IC (Main).
Outdoor Unit	51 to 100	Use the smallest address of all the indoor units plus 50. The address automatically becomes "100" if it is set as "01-50".
Main M-NET Remote Controller	101 to 150	Set at an M-IC (Main) address within the same group plus 100.
Sub M-NET Remote Controller	151 to 200	Set at an M-IC (Main) address within the same group plus 150.
MA Remote Controller	—	Address setting is not necessary. (Main/sub setting is necessary.)

• Name, Symbol, and the Maximum Units for Connection

Permissible Length
 Maximum line distance via outdoor unit (M-NET cable): $L_1+L_2+L_3+L_4$ and $L_1+L_2+L_6+L_7 \leq 500$ m (1.25 mm² more)
 Indoor/outdoor transmission line Maximum distance (M-NET cable): L_1 and L_3+L_4 and L_2+L_6 and $L_7 \leq 200$ m (1.25 mm² or more)
 MA Remote controller cable length: m_1 and $m_1+m_2+m_3$ and $m_1+m_2+m_3+m_4 \leq 200$ m (0.3 to 1.25 mm²)

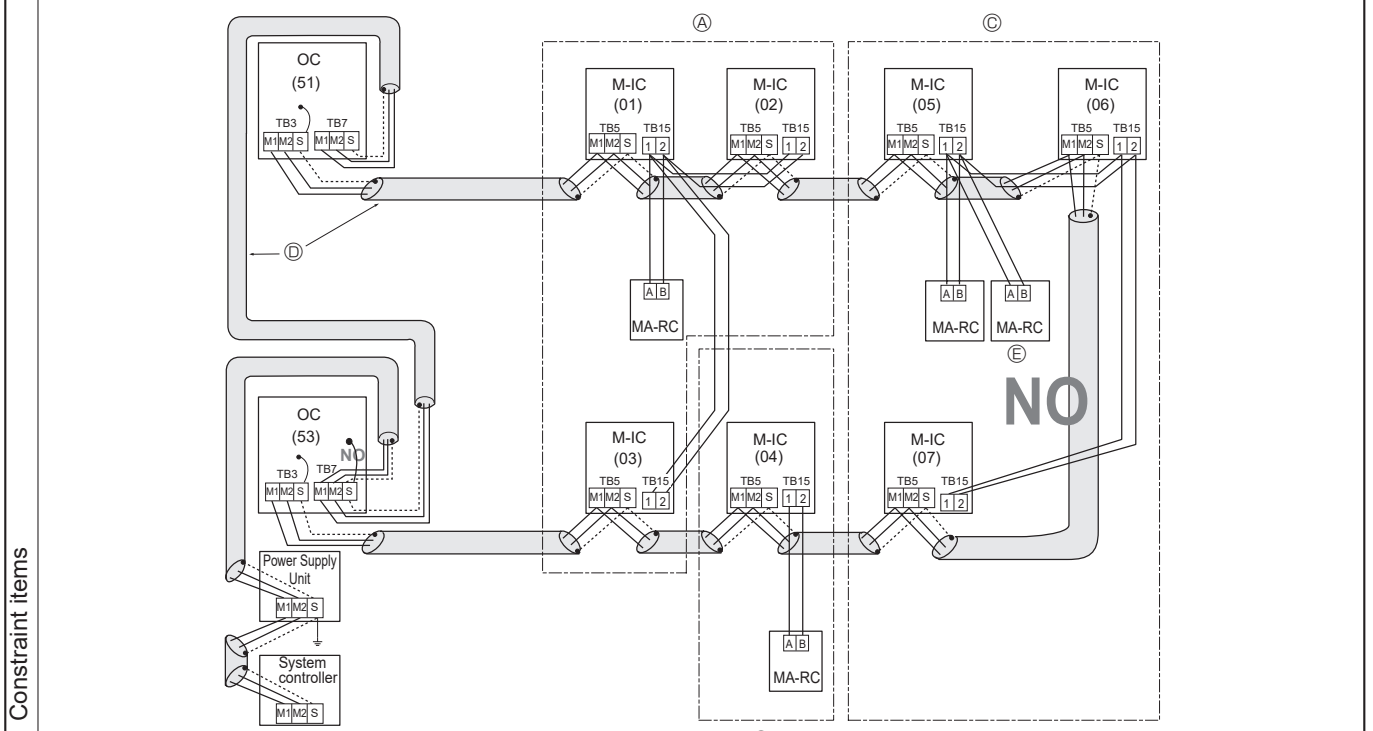

- (A) : Group
- (B) : Group
- (C) : Group
- (D) : Shielded Wire
- (E) : Sub MA Remote Controller
- () : Address example

- Never connect together the terminal blocks (TB5) for transmission wires for CITY MULTI series indoor units (M-IC) that have been connected to different outdoor units (OC).
- M-NET remote controller and MA remote controller cannot be connected with the CITY MULTI series indoor unit of the same group wiring together.

E. Example of a system using Branch Box and A-Control indoor unit

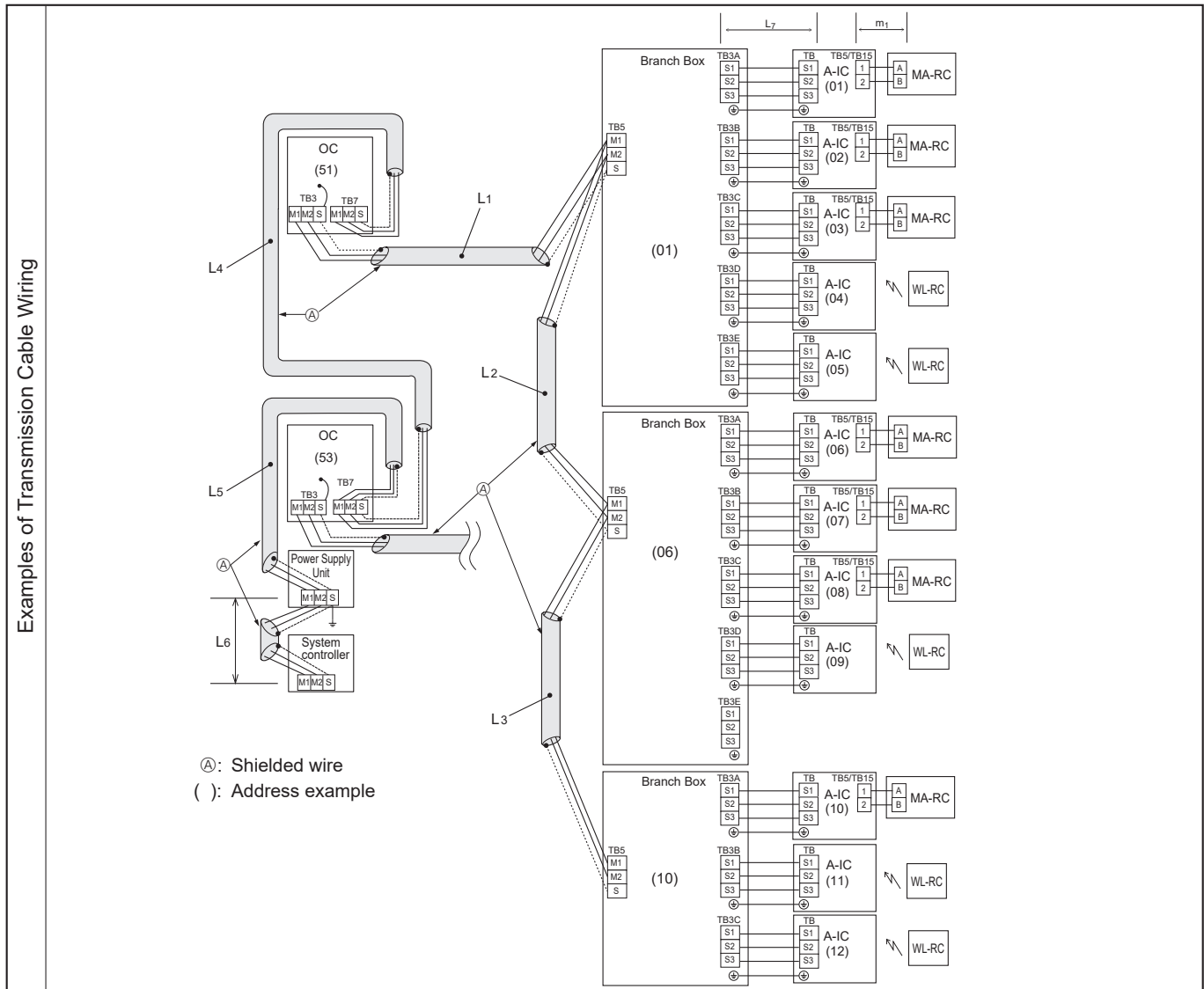

- Wiring Method Address Settings
- Always use shielded wire when making connections between the outdoor unit (OC) and the Branch Box, as well for all OC-OC wiring intervals.
 - Use feed wiring to connect terminals M1 and M2 and the ground terminal on the transmission cable terminal block (TB3) of each outdoor unit (OC) to terminals M1 and M2 on the terminal S on the transmission cable terminal block (TB5) of the Branch Box.
 - Connect terminals 1 and 2 on the transmission cable terminal block (TB5/TB15) of the A-control indoor unit (A-IC), to the terminal block on the MA remote controller (MA-RC).
 - Connect together terminals M1, M2 and terminal S on the terminal block for centralized control (TB7) for the outdoor unit (OC).
 - DO NOT change the jumper connector CN41 on outdoor multi controller circuit board.
 - The earth processing of S terminal for the centralized control terminal block (TB7) is unnecessary. Connect the terminal S on the power supply unit to the earth.
 - Set the address setting switch as follows.

Unit	Range	Setting Method
A-IC	01 to 50	According to the set address of connected Branch Box, set the A-IC addresses sequentially by SW1 on Branch Box. (For example, when setting the Branch Box address to 01, A-IC addresses set 02,03,04, and 05.)
Branch Box	01 to 50	Use a number within the range 1–50, but it should not make the highest address of connected A-IC exceed 50.
Outdoor Unit	51 to 100	Use the smallest address of all the Branch Box plus 50. The address automatically becomes “100” if it is set as “01–50”.
MA Remote Controller	–	Address setting is not necessary.

• Name, Symbol, and the Maximum Units for Connection

Permissible Length

Maximum line distance via outdoor unit (M-NET cable): $L_1+L_2+L_3+L_4+L_5+L_6 \leq 500$ m (1.25 mm² or more)
 Branch box/outdoor transmission line Maximum distance (M-NET cable): $L_1+L_2+L_3, L_4+L_5, L_6 \leq 200$ m (1.25 mm² or more)
 Indoor/branch box transmission line Maximum distance (A-Control cable): $L_7 \leq 25$ m (1.5 mm²)
 Remote controller cable length: $m_1 \leq 200$ m (0.3 to 1.25 mm²)

Constraint items

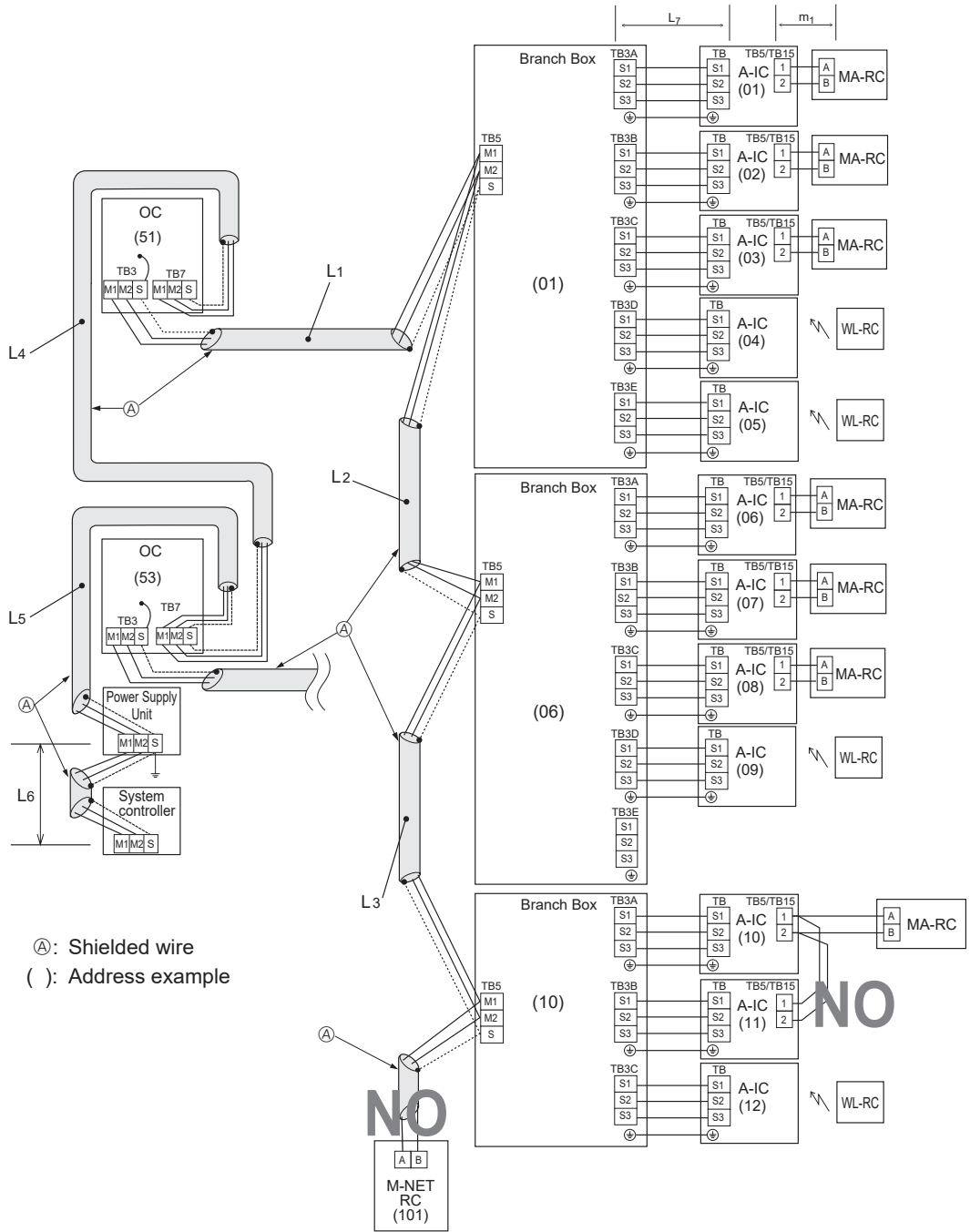

- Plural indoor units cannot be operated by an MA single remote controller.
- Different refrigerant systems cannot be connected together.
- M-NET Remote controller cannot be connected to this system.

Example of a system using Branch Box and A-Control indoor unit

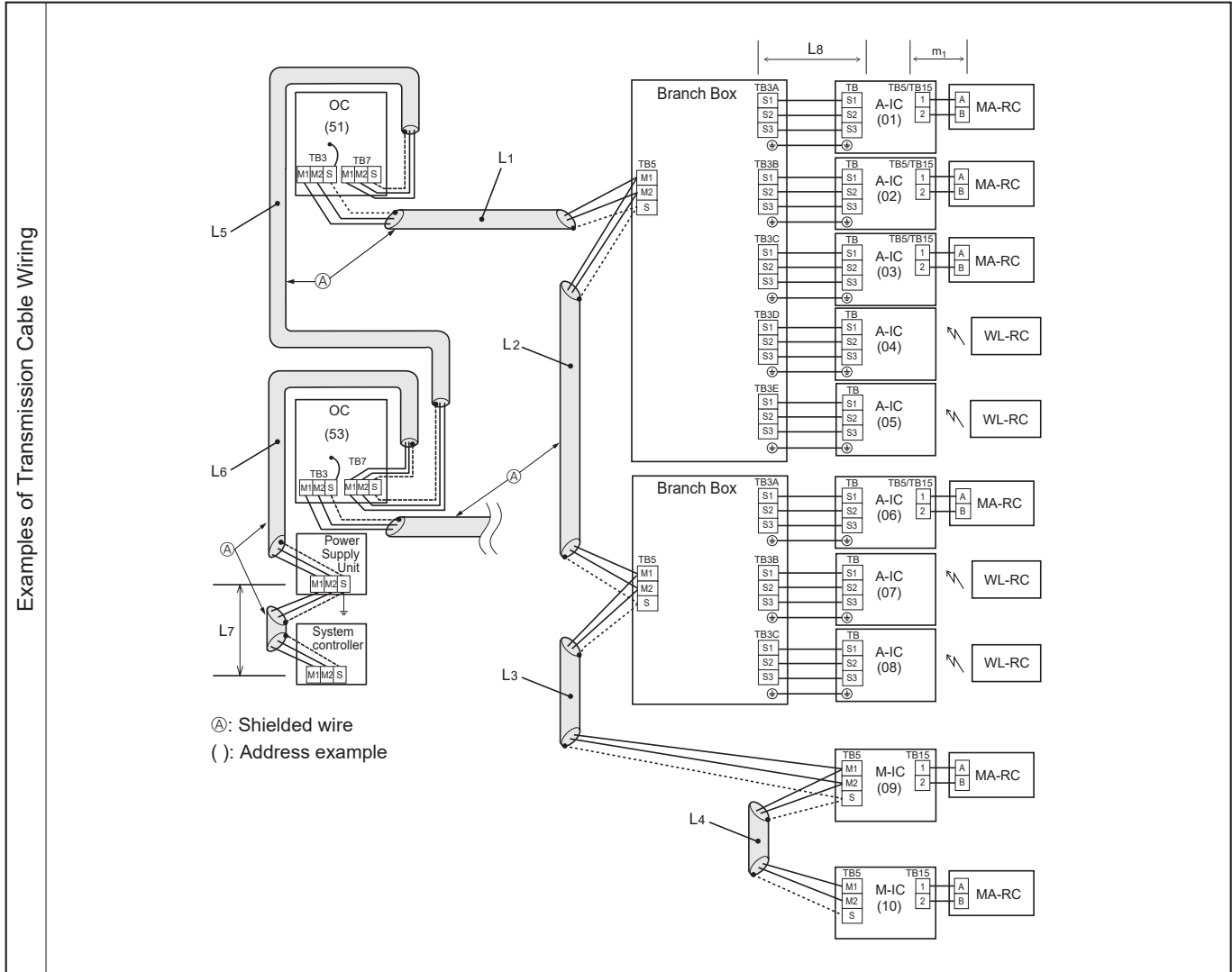

- Wiring Method Address Settings
- a. Always use shielded wire when making connections between the outdoor unit (OC) and the Branch Box as well for all OC-OC wiring intervals.
 - b. Use feed wiring to connect terminals M1 and M2 and the ground terminal on the transmission cable terminal block (TB3) of each outdoor unit (OC) to terminals M1 and M2 on the terminal S on the transmission cable terminal block (TB5) of the Branch Box.
 - c. Connect terminals 1 and 2 on the transmission cable terminal block (TB5/TB15) of the A-control indoor unit (A-IC) to the terminal block on the MA remote controller (MA-RC).
 - d. Connect together terminals M1, M2 and terminal S on the terminal block for centralized control (TB7) for the outdoor unit (OC).
 - e. DO NOT change the jumper connector CN41 on MULTI controller board.
 - f. The earth processing of S terminal for the centralized control terminal block (TB7) is unnecessary. Connect the terminal S on the power supply unit to the earth.
 - g. Set the address setting switch as follows.

Unit	Range	Setting Method
M-IC	01 to 50	—
A-IC	01 to 50	According to the set address of connected Branch Box, set the A-IC addresses sequentially by SW1, SW11, SW12 on Branch Box. (For example, when the Branch Box address is set to 01, set the A-IC addresses to 01, 02, 03, 04 and 05.)
Branch Box	01 to 50	Use a number within the range 1-50, but it should not make the highest address of connected A-IC exceed 50.
Outdoor Unit	51 to 100	Use the smallest address of all the Branch Box plus 50. The address automatically becomes "100" if it is set as "01-50".
MA Remote Controller	—	Address setting is not necessary.

• Name, Symbol, and the Units for Connection

Permissible Length

Maximum line distance via outdoor unit (M-NET cable): $L_1+L_2+L_3+L_4+L_5+L_6+L_7 \leq 500$ m (1.25 mm² or more)
 Indoor/branch box/outdoor transmission line Maximum distance (M-NET cable): $L_1+L_2+L_3+L_4, L_5+L_6, L_7 \leq 200$ m (1.25 mm² or more)
 Indoor/branch box transmission line Maximum distance (A-Control cable): $L_8 \leq 25$ m (1.5 mm²)
 Remote controller cable length: $m_1 \leq 200$ m (0.3 to 1.25 mm²)

Constraint items

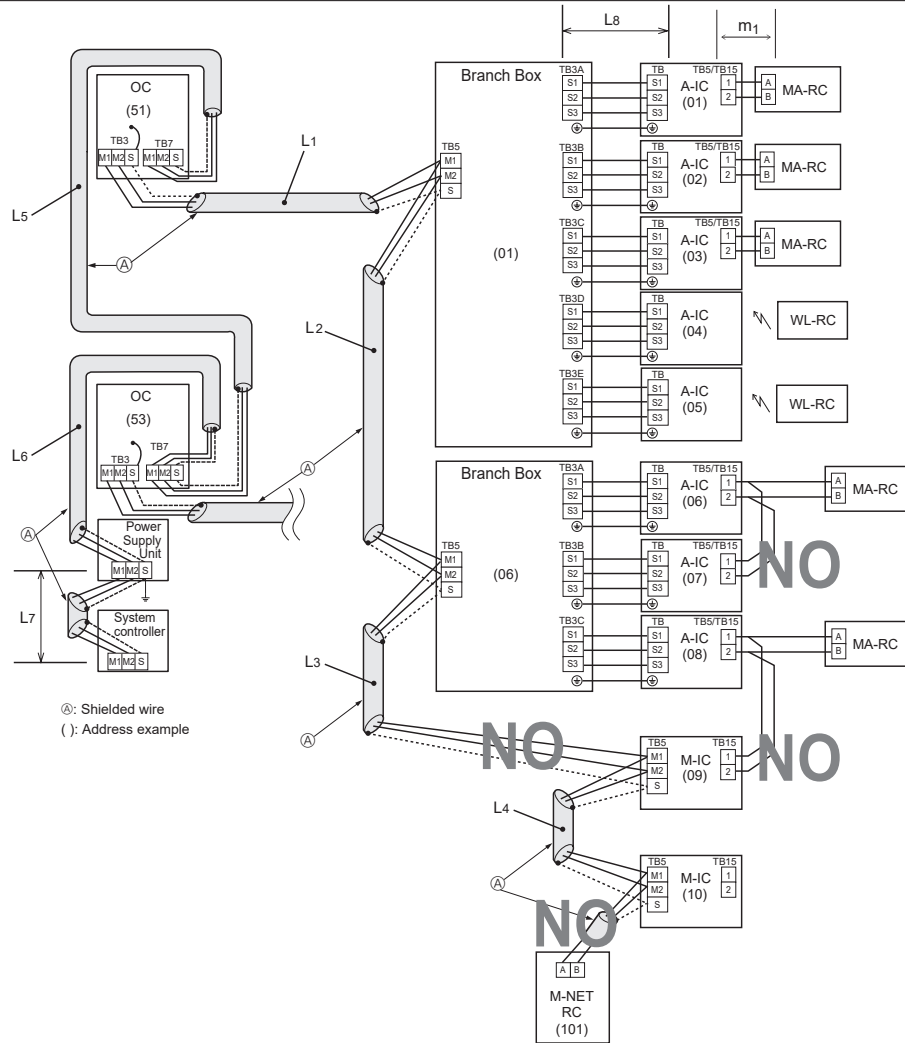

- Plural indoor units cannot be operated by a single remote controller.
- Different refrigerant systems cannot be connected together.
- M-NET Remote controller cannot be connected to this system.

8-1. CHECKPOINTS FOR TEST RUN

8-1-1. Procedures before test run

- (1) Before a test run, make sure that the following work is completed.
 - Installation related:
 - Make sure that the panel of cassette type and electrical wiring are done.
 - Otherwise electrical functions like auto vane will not operate normally.
 - Piping related:
 - Perform leakage test of refrigerant and drain piping.
 - Make sure that all joints are perfectly insulated.
 - Check stop valves on both liquid and gas side for full open.
 - Electrical wiring related:
 - Check ground wire, transmission cable, remote controller cable, and power supply cable for secure connection.
 - Make sure that all switch settings of address or adjustments for special specification systems are correctly settled.
- (2) Safety check:
 - With the insulation tester of 500V, inspect the insulation resistance.
 - Do not touch the transmission cable and remote controller cable with the tester.
 - The resistance should be over 1.0 MΩ. Do not proceed inspection if the resistance is less than 1.0 MΩ.
 - Inspect between the outdoor unit power supply terminal block and ground first, metallic parts like refrigerant pipes or the electrical box next, then inspect all electrical wiring of outdoor unit, indoor unit, and all linked equipment .
- (3) Before operation:
 - a) Turn the power supply switch of the outdoor unit to on for compressor protection. For a test run, wait at least 12 hours from this point.
 - b) Register control systems into remote controller(s). Never touch the on/off switch of the remote controller(s). Refer to "12-9. Special Function Operation and Settings for M-NET Remote Controller" as for settings. In MA remote controller(s), this registration is unnecessary.
- (4) More than 12 hours later from power supply to the outdoor unit, turn all power switch to on for the test run. Perform test run according to 12-4. While test running, make test run reports.

8-1-2. Test run for wired remote controller

Refer to 12-4. "TEST RUN" for operation procedure.

Note: When you deliver the unit after the test run, instruct the end user for proper usage of the system using owners' manual and the test run report you made to certificate normal operation. If abnormalities are detected during test run, refer to "8-1-3. Countermeasures for Error During Test Run". As for DIP switch setting of outdoor unit, refer to "8-4. INTERNAL SWITCH FUNCTION TABLE".

8-1-3. Countermeasures for Error During Test Run

- If a problem occurs during test run, a code number will appear on the remote controller (or LED on the outdoor unit), and the air conditioning system will automatically cease operating.

Determine the nature of the abnormality and apply corrective measures.

Check code (2 digits)	Check code (4 digits)	Trouble	Detected Unit			Remarks
			Indoor	Outdoor	Remote Controller	
Ed	0403	Serial communication error		○		Outdoor unit outdoor multi controller circuit board – Power circuit board communication trouble
U2	1102	Compressor temperature trouble		○		Check delay code 1202
UE	1302	High pressure trouble or High compressor temperature (TRS) trouble		○		Check delay code 1402
U7	1500	Superheat due to low discharge temperature trouble		○		Check delay code 1600
U2	1501	Refrigerant shortage trouble		○		Check delay code 1601
		Closed valve in cooling mode		○		Check delay code 1501
P6	1503	Freeze protection of Branch box or Indoor unit		○		
EF	1508	4-way valve trouble in heating mode		○		Check delay code 1608
PA	2500	Water leakage	○			
P5	2502	Drain overflow protection	○			
P4	2503	Drain sensor trouble	○			
UF	4100	Compressor current interruption (locked compressor)		○		Check delay code 4350
Pb	4114	Fan trouble (indoor)	○			
UP	4210	Compressor overcurrent interruption/failure in 12 VDC power supply circuit on power circuit board		○		
U9	4220	Undervoltage/overvoltage/PAM error/L1 open phase/power synchronization signal error		○		Check delay code 4320
U5	4230	Heat sink temperature trouble		○		Check delay code 4330
U6	4250	Power module trouble or overcurrent trouble		○		Check delay code 4350
U8	4400	Fan trouble (outdoor)		○		Check delay code 4500
U3	5101	Air inlet thermistor (TH21) open/short or	○			
		Compressor temperature thermistor (TH4) open/short		○		Check delay code 1202
U4	5102	Liquid pipe temperature thermistor (TH22) open/short or	○			
		Suction pipe temperature thermistor (TH6) open/short		○		Check delay code 1211
U4	5103	Gas pipe temperature thermistor (TH23) open/short	○			
U4	5105	Outdoor liquid pipe temperature thermistor (TH3) open/short		○		Check delay code 1205
U4	5106	Ambient thermistor (TH7) open/short		○		Check delay code 1221
U4	5109	HIC pipe temperature thermistor (TH2) open/short		○		Check delay code 1222
U4	5110	Heat sink temperature thermistor (TH8) open/short		○		Check delay code 1214
F5	5201	High pressure sensor (63HS) trouble		○		Check delay code 1402
F3	5202	Low pressure sensor (63LS) trouble		○		Check delay code 1400
UH	5300	Current sensor trouble		○		Check delay code 4310
P4	5701	Contact failure of drain float switch	○			
A0	6600	Duplex address error	○	○	○	Only M-NET Remote controller is detected.
A2	6602	Transmission processor hardware error	○	○	○	Only M-NET Remote controller is detected.
A3	6603	Transmission bus BUSY error	○	○	○	Only M-NET Remote controller is detected.
A6	6606	Signal communication error with transmission processor	○	○	○	Only M-NET Remote controller is detected.
A7	6607	No ACK error	○	○	○	Only M-NET Remote controller is detected.
A8	6608	No response frame error	○	○	○	Only M-NET Remote controller is detected.
E0/E4	6831	MA communication receive error (no receive signal)	○		○	Only MA Remote controller is detected.
E3/E5	6832	MA communication send error	○		○	Only MA Remote controller is detected.
E3/E5	6833	MA communication send error	○		○	Only MA Remote controller is detected.
E0/E4	6834	MA communication receive error	○		○	Only MA Remote controller is detected.
EF	7100	Total capacity error		○		
EF	7101	Capacity code error	○	○		
EF	7102	Connecting unit number error		○		
EF	7105	Address setting error		○		
EF	7130	Incompatible unit combination		○		

Notes:

1. When the outdoor unit detects No ACK error/No response error, an object indoor unit is treated as a stop, and not assumed to be abnormal.
2. Refer to the service manual of indoor unit or remote controller for the detail of error detected in indoor unit or remote controller.

Self-diagnosis function

The indoor and outdoor units can be diagnosed automatically using the self-diagnosis switch (SW1, SWP2) and LED1, LED2 (LED indication) found on the multi-controller of the outdoor unit.
LED indication : Set all contacts of SW1 to OFF.

During normal operation

The LED indicates the drive state of the controller in the outdoor unit.

Bit	1	2	3	4	5	6	7	8
Indication	Compressor operated	52C	21S4	SV1	(SV2)	SV3	—	Always lit

[Example]

When the compressor and SV1 are turned during cooling operation.

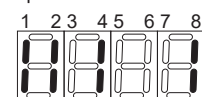

Check code

0403
(Ed)

Serial communication error

Abnormal points and detection methods	Causes and checkpoints
If serial communication between the outdoor multi controller circuit board and outdoor power circuit board is defective.	<ul style="list-style-type: none"> ① Wire breakage or contact failure of connector CN2 or CN4 ② Malfunction of communication circuit to power circuit board on outdoor multi controller circuit board ③ Malfunction of communication circuit on outdoor power circuit board

●Diagnosis of defects

Make sure to turn the power OFF before connecting/disconnecting any connectors, or replacing boards.

Diagnosis	Remedy
<p>Check the connection of the communication line (CN2 and CN4) between the outdoor controller board and power board.</p> <p>Are they connected normally?</p> <p>Yes</p> <p>Check the wiring.</p> <p>Are they connected normally?</p> <p>Yes</p>	<p>Connect the CN2 and CN4 properly. Replace them in the case of breakage.</p> <p>Connect the wiring properly. Replace them in the case of breakage.</p> <p>The communication circuit of either the outdoor controller board or power board is defective. If unable to identify the defective circuit; ①Replace the outdoor controller board if it does not recover, ②Replace the outdoor power board.</p>

Compressor temperature trouble

Abnormal points and detection methods	Causes and checkpoints
<p>(1) If TH4 falls into following temperature conditions;</p> <ul style="list-style-type: none"> ●exceeds 110°C continuously for 5 minutes ●exceeds 125°C <p>(2) If a pressure detected by the high pressure sensor and converted to saturation temperature exceeds 40°C during defrosting, and TH4 exceeds 110°C.</p> <p>TH4: Thermistor <Compressor> LEV: Linear expansion valve</p>	<p>① Malfunction of stop valve ② Over-heated compressor operation caused by shortage of refrigerant ③ Defective thermistor ④ Defective outdoor multi controller circuit board ⑤ LEV performance failure ⑥ Defective indoor controller board ⑦ Clogged refrigerant system caused by foreign object ⑧ Refrigerant shortage (Refrigerant liquid accumulation in compressor while indoor unit is OFF/thermo-OFF.)</p>

●Diagnosis of defects

Make sure to turn the power OFF before connecting/disconnecting any connectors, or replacing boards.

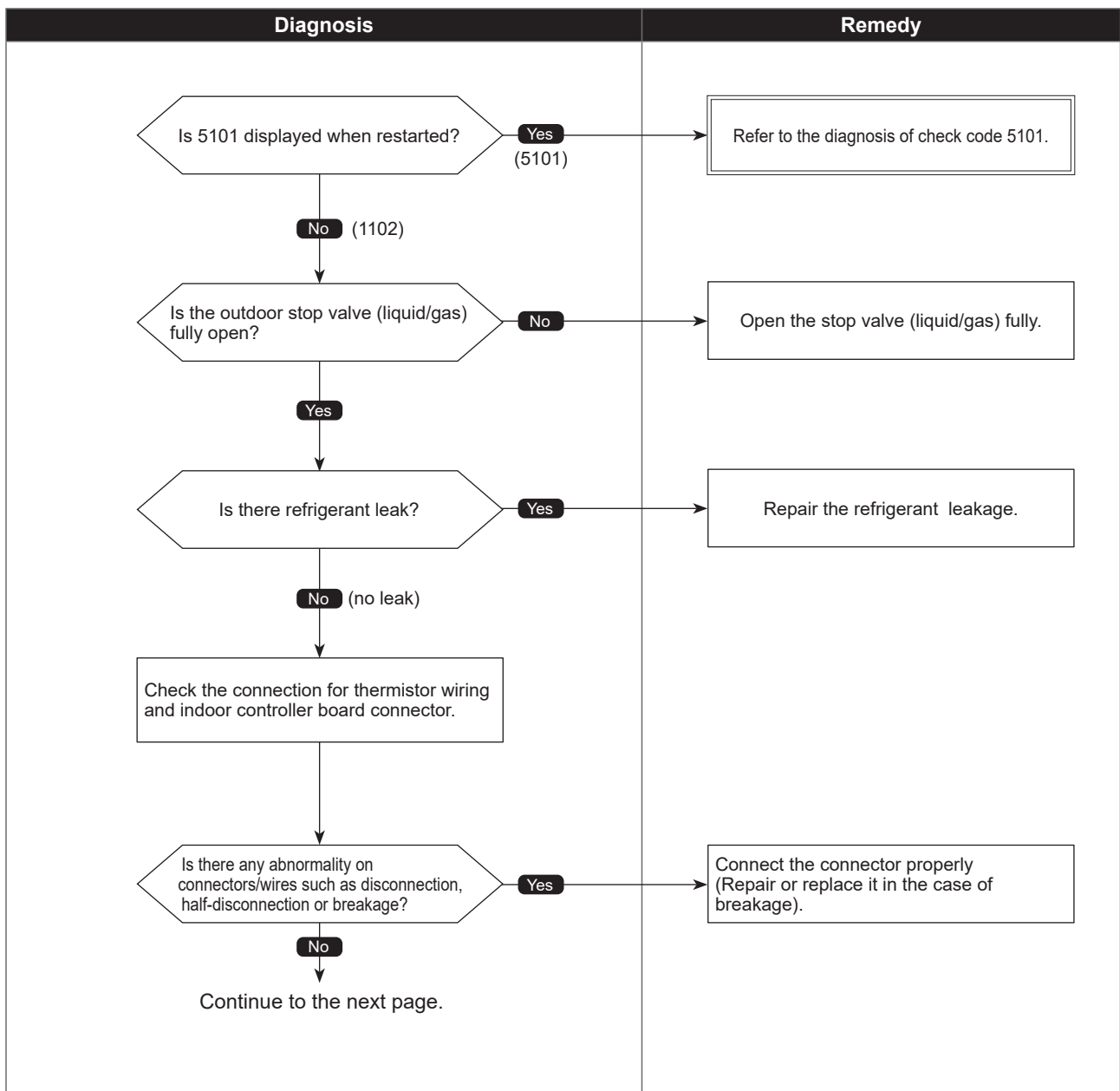

●Diagnosis of defects

Make sure to turn the power OFF before connecting/disconnecting any connectors, or replacing boards.

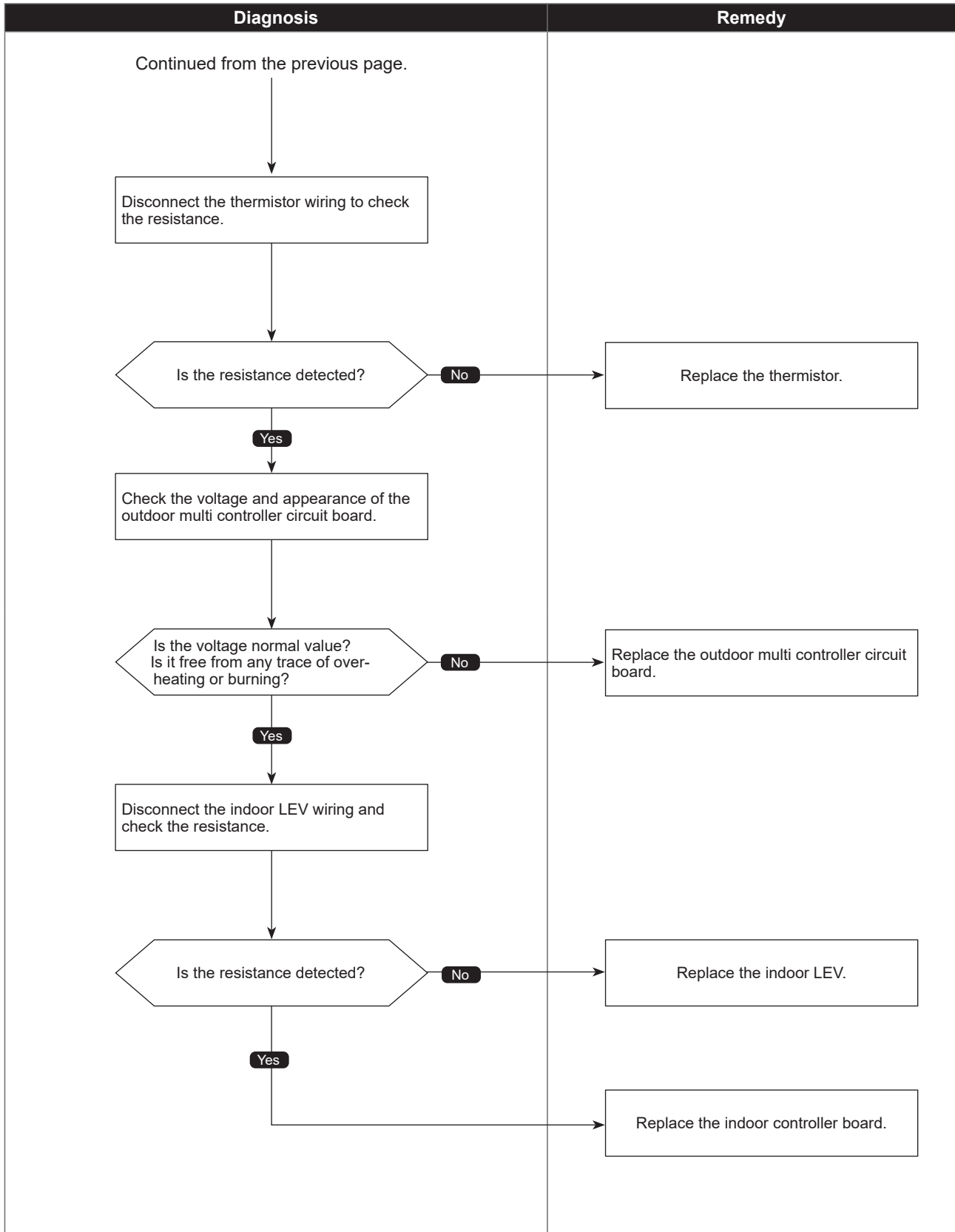

High pressure trouble or High compressor temperature trouble

Abnormal points and detection methods	Causes and checkpoints
<p>(1) High pressure abnormality (63H operation) If 63H operates(*) during compressor operation. (* 4.15 MPa)</p> <p>(2) High pressure abnormality (63HS detected) 1. If a pressure detected by 63HS is 4.31 MPa or more during compressor operation. 2. If a pressure detected by 63HS is 4.14 MPa or more for 3 minutes during compressor operation.</p> <p>3) High compressor temperature abnormally (TRS operation). Abnormal if TRS operate (130°C) during compressor operation.</p> <p>63H: High pressure switch 63HS: High pressure sensor LEV: Linear expansion valve SV1: Solenoid valve TH7: Thermistor <Ambient> TRS: Compressor protector</p>	<p>① Defective operation of stop valve (not fully open) ② Clogged or broken pipe ③ Malfunction or locked outdoor fan motor ④ Short-cycle of outdoor unit ⑤ Dirt of outdoor heat exchanger ⑥ Remote controller transmitting error caused by noise interference ⑦ Contact failure of the outdoor multi controller circuit board connector ⑧ Defective outdoor multi controller circuit board ⑨ Short-cycle of indoor unit ⑩ Decreased airflow, clogged filter, or dirt on indoor unit. ⑪ Malfunction or locked indoor fan motor ⑫ Decreased airflow caused by defective inspection of outdoor temperature thermistor (It detects lower temperature than actual temperature.) ⑬ Indoor LEV performance failure ⑭ Malfunction of fan driving circuit ⑮ SV1 performance failure ⑯ Defective high pressure sensor ⑰ Defective high pressure sensor input circuit on outdoor multi controller circuit board ⑱ Refrigerant shortage Refrigerant/liquid accumulation in compressor while indoor unit is OFF/Thermo-OFF)</p>

●Diagnosis of defects

Make sure to turn the power OFF before connecting/disconnecting any connectors, or replacing boards.

Diagnosis	Remedy
<p>Is 5201 displayed when restarted?</p> <p>Yes (5201)</p> <p>No (1302)</p>	<p>Refer to the diagnosis of check code 5201.</p>
<p>Is the outdoor stop valve (liquid/gas) fully open?</p> <p>No</p> <p>Yes</p>	<p>Open the stop valve (liquid/gas) fully.</p>
<p>Does the outdoor fan rotate during the operation?</p> <p>No</p> <p>Yes</p>	<p>Check the outdoor fan motor. Refer to "How to check the parts" on the outdoor unit service manual.</p>
<p>Does the indoor fan rotate during the operation?</p> <p>No</p> <p>Yes</p>	<p>Check the indoor fan motor. Refer to "How to check the parts" on the indoor unit service manual.</p>
<p>Is the indoor unit short-cycled?</p> <p>Yes (short-cycled)</p> <p>No (no short-cycle)</p> <p>Continue to the next page.</p>	<p>Resolve the short-cycle.</p>

High pressure trouble or High compressor temperature trouble

●Diagnosis of defects

Make sure to turn the power OFF before connecting/disconnecting any connectors, or replacing boards.

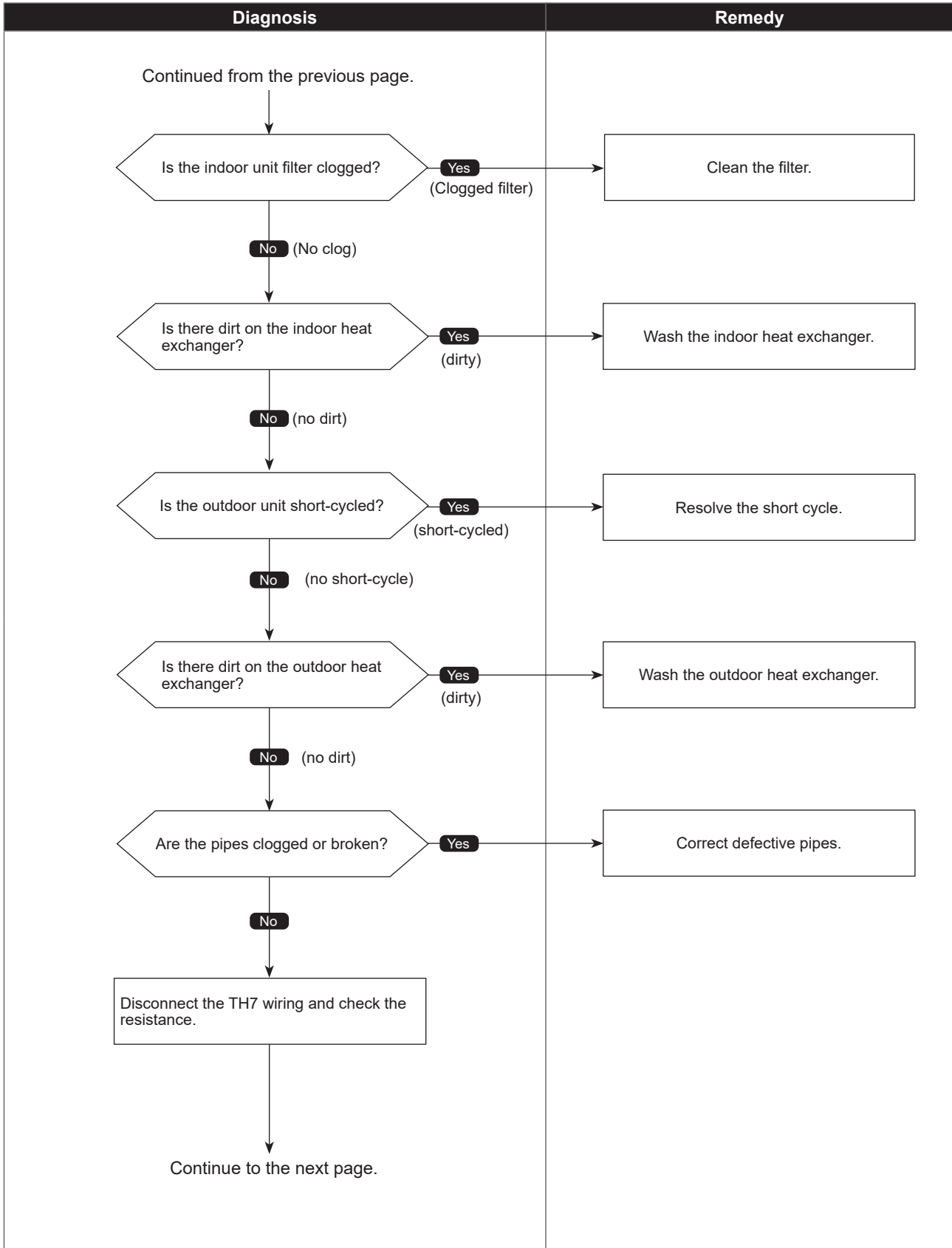

High pressure trouble or High compressor temperature trouble

●Diagnosis of defects

Make sure to turn the power OFF before connecting/disconnecting any connectors, or replacing boards.

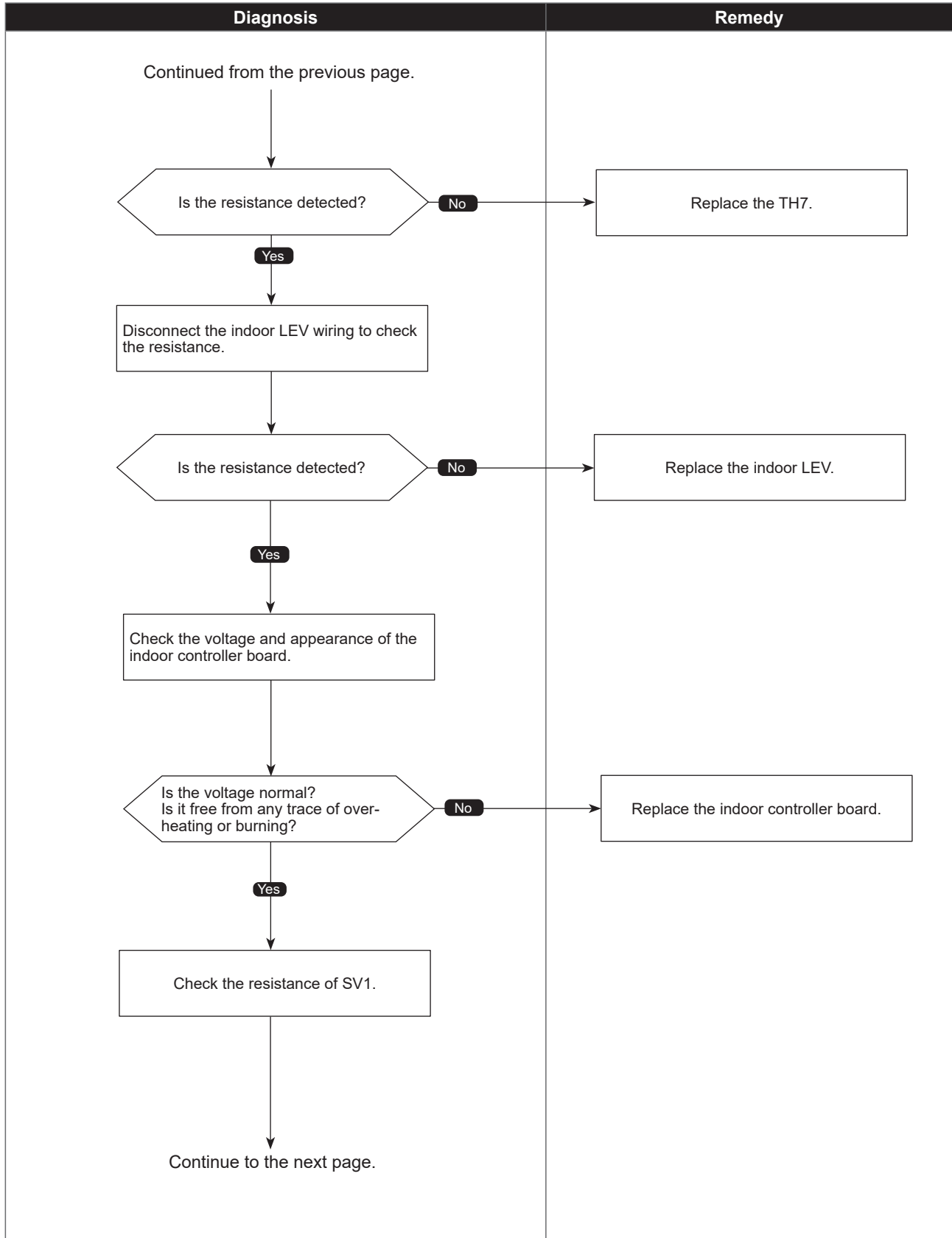

High pressure trouble or High compressor temperature trouble

●Diagnosis of defects

Make sure to turn the power OFF before connecting/disconnecting any connectors, or replacing boards.

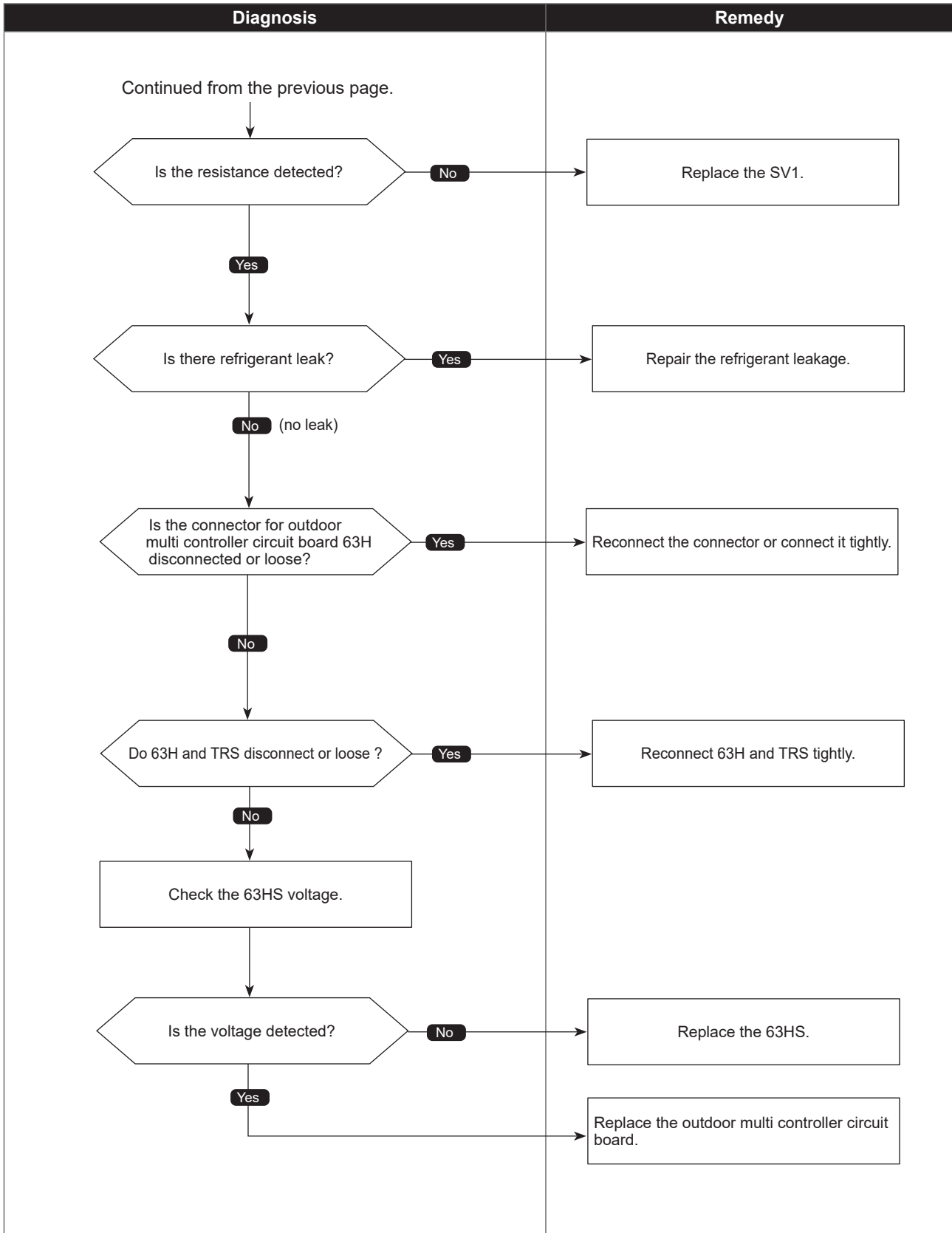

Superheat due to low discharge temperature trouble

Abnormal points and detection methods	Causes and checkpoints
<p>If the discharge superheat is continuously detected -15°C or less (*) for 5 minutes even though the indoor LEV has minimum open pulse after the compressor starts operating for 10 minutes.</p> <p>LEV: Linear expansion valve TH4: Thermistor <Compressor> 63HS: High pressure sensor</p> <p>*At this temperature, conditions for the abnormality detection will not be satisfied if no abnormality is detected on either TH4 or 63HS.</p>	<ul style="list-style-type: none"> ① Disconnection or loose connection of TH4 ② Defective holder of TH4 ③ Disconnection of LEV coil ④ Disconnection of LEV connector ⑤ LEV performance failure

●Diagnosis of defects

Make sure to turn the power OFF before connecting/disconnecting any connectors, or replacing boards.

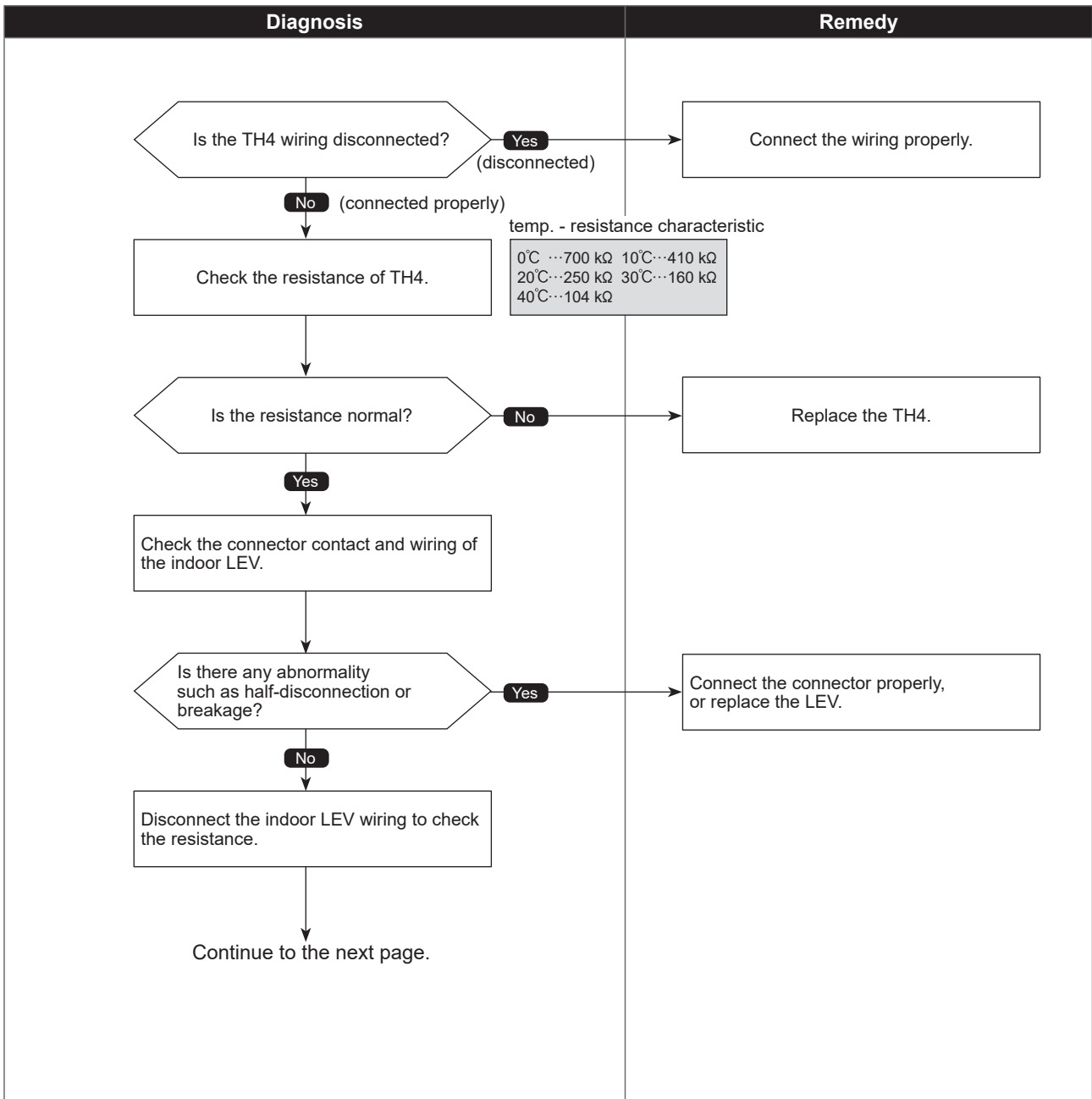

●Diagnosis of defects

Make sure to turn the power OFF before connecting/disconnecting any connectors, or replacing boards.

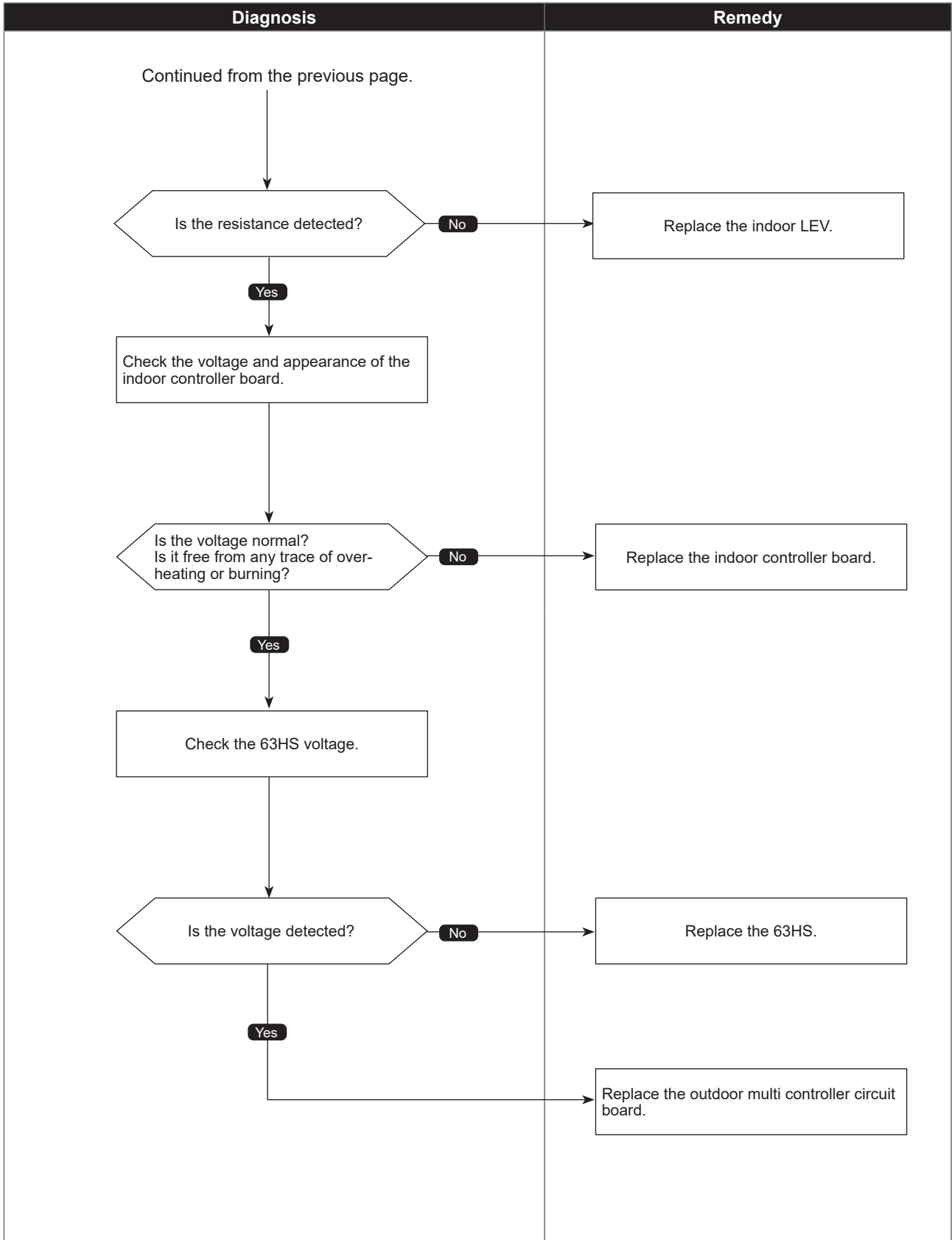

Refrigerant shortage trouble

Abnormal points and detection methods	Causes and checkpoints
<p>(1) When all of the following conditions have been satisfied for 15 consecutive minutes:</p> <ol style="list-style-type: none"> The compressor is operating in HEAT mode. Discharge super heat is 80°C or more. Difference between TH7 and the TH3 applies to the formula of (TH7-TH3 < 5°C). The saturation temperature converted from a high pressure sensor detects below 35°C. <p>(2) When all of the following conditions have been satisfied:</p> <ol style="list-style-type: none"> The compressor is in operation. When cooling, discharge superheat is 80°C or more, and the saturation temperature converted from a high pressure sensor is over -40°C. When heating, discharge superheat is 90°C or more. 	<ol style="list-style-type: none"> Defective operation of stop valve (not fully open) Defective thermistor Defective outdoor multi controller circuit board Indoor LEV performance failure Gas leakage or shortage Defective 63HS <p>TH3: Thermistor <Outdoor liquid pipe> TH7: Thermistor <Ambient> LEV: Linear expansion valve 63HS: High pressure sensor</p>

●Diagnosis of defects

Make sure to turn the power OFF before connecting/disconnecting any connectors, or replacing boards.

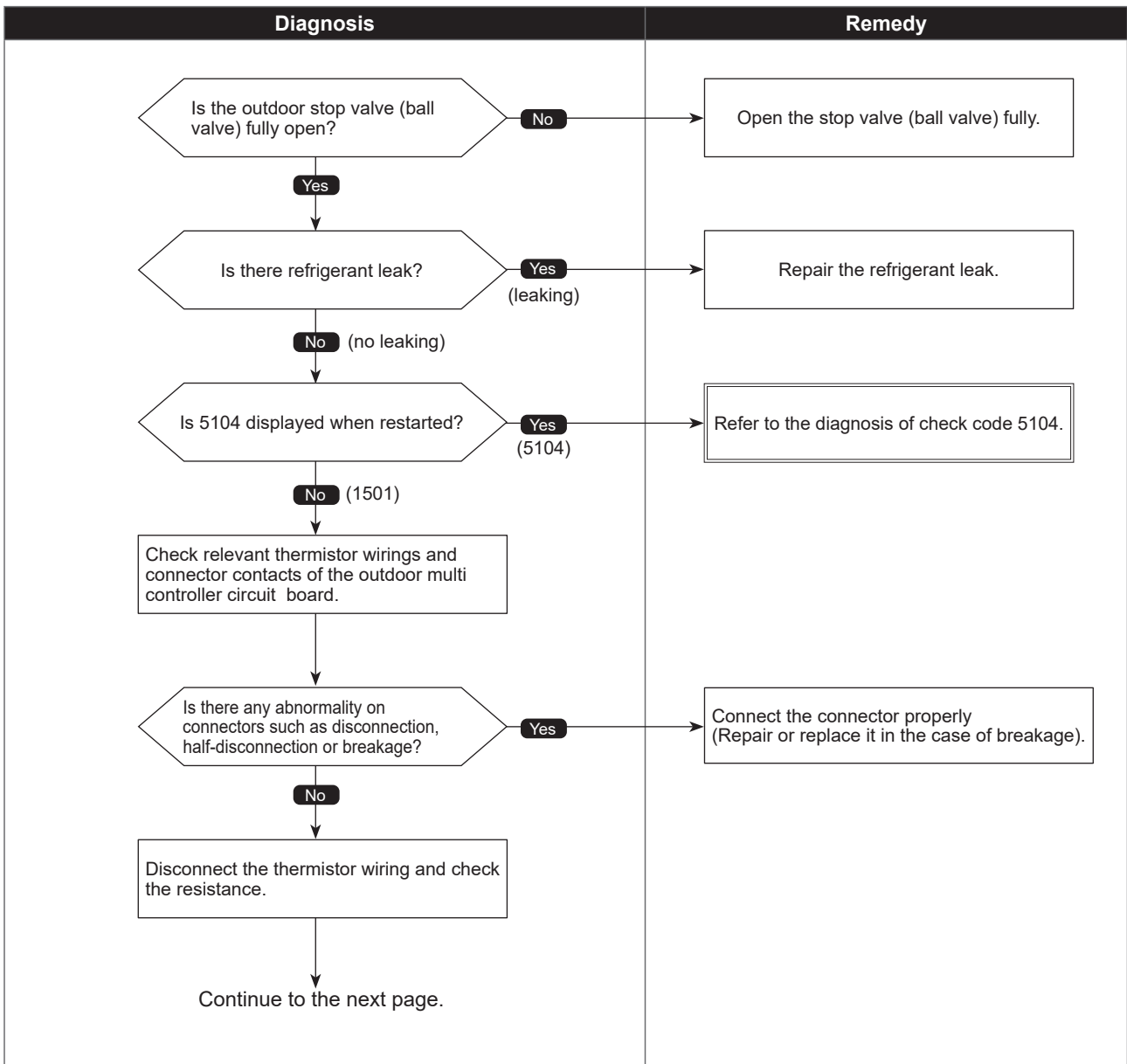

Refrigerant shortage trouble

●Diagnosis of defects

Make sure to turn the power OFF before connecting/disconnecting any connectors, or replacing boards.

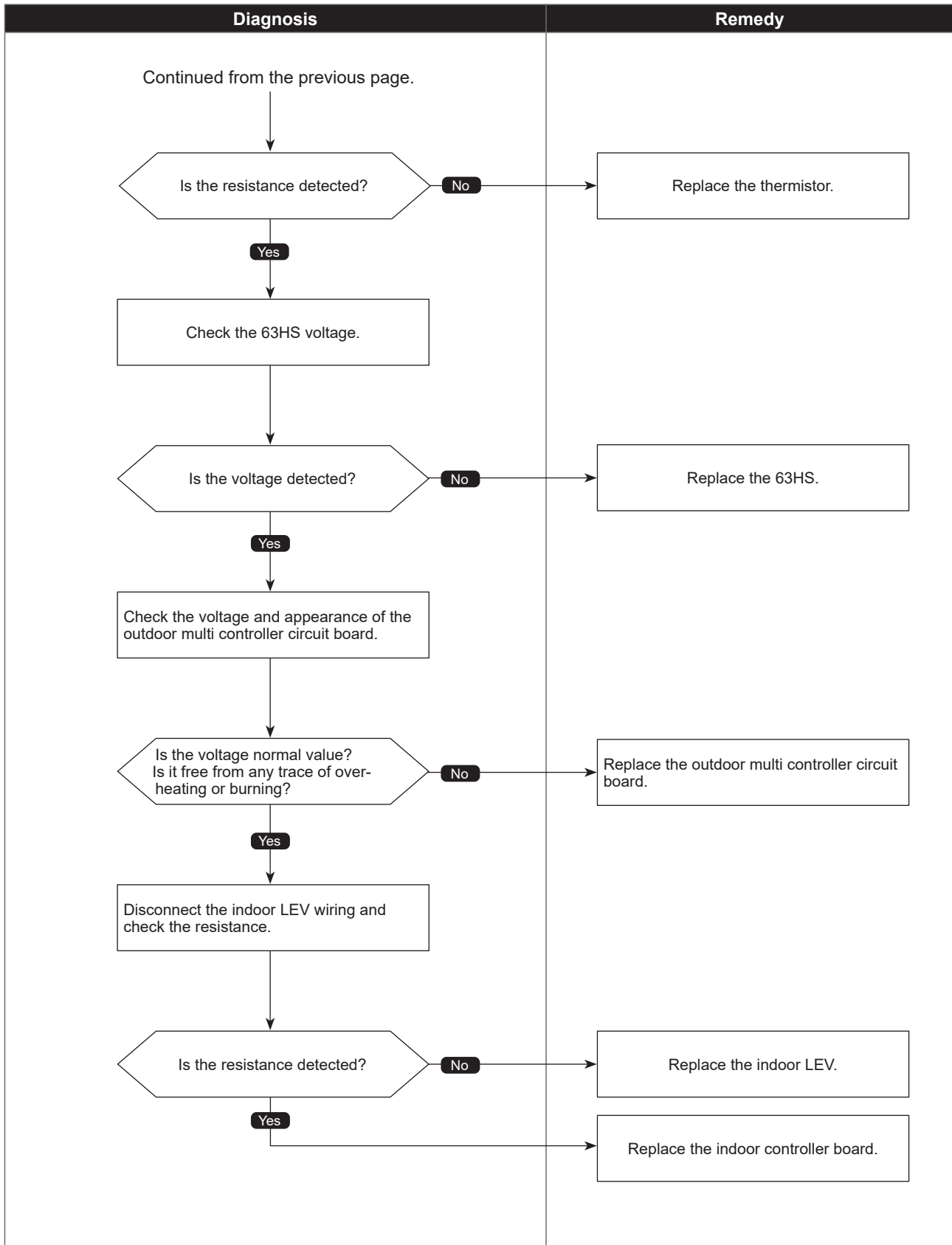

Check code

1501
(U2)

Closed valve in cooling mode

Abnormal points and detection methods	Causes and checkpoints
<p>If stop valve is closed during cooling operation.</p> <p>When both of the following temperature conditions have been satisfied for 20 minutes or more during cooling operation.</p> <ol style="list-style-type: none"> 1. TH22j-TH21j $\geq -2^{\circ}\text{C}$ 2. TH23j-TH21j $\geq -2^{\circ}\text{C}$ <p>Note: For indoor unit, the abnormality is detected if an operating unit satisfies the condition.</p>	<ol style="list-style-type: none"> ① Outdoor liquid/gas valve is closed. ② Malfunction of outdoor LEV (LEV-A)(blockage) <p>TH21: Indoor intake temperature thermistor TH22: Indoor liquid pipe temperature thermistor TH23: Indoor gas pipe temperature thermistor LEV: Linear expansion valve</p>

●Diagnosis of defects

Make sure to turn the power OFF before connecting/disconnecting any connectors, or replacing boards.

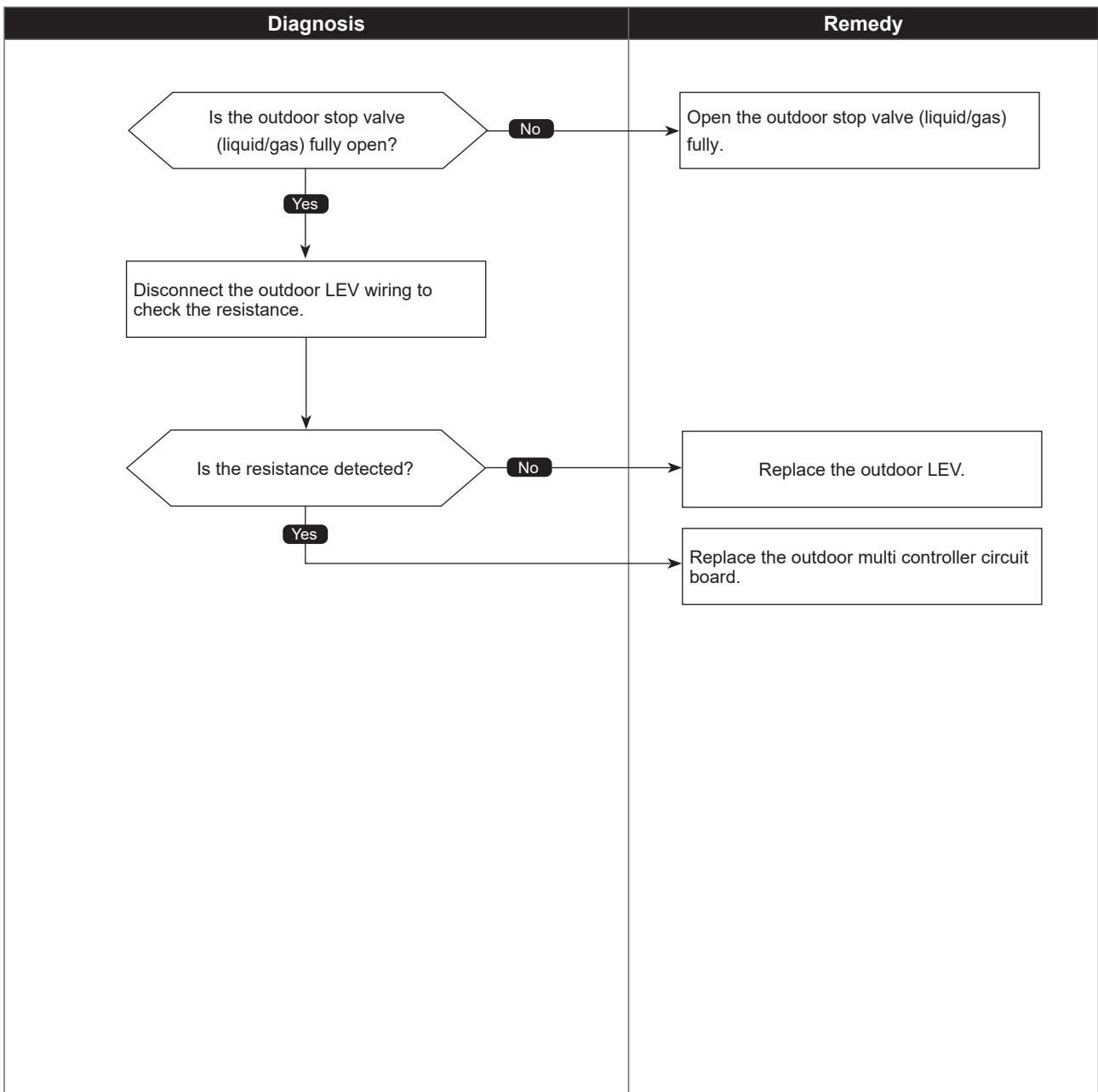

Check code

1503
(P6)

Freeze protection of branch box or indoor unit

Abnormal points and detection methods	Causes and checkpoints
<p>The purpose of the check code is to prevent indoor unit from freezing or dew condensation which is caused when a refrigerant keeps flowing into the unit in STOP.</p> <p>When all of the following conditions have been satisfied:</p> <ol style="list-style-type: none"> 1. The compressor is operating in COOL mode. 2. 15 minutes have passed after the startup of the compressor, or the change in the number of operating indoor units is made (including a change by turning thermo-ON/OFF). 3. After the condition 2 above is satisfied, the thermistor of indoor unit in STOP detects TH22] $\leq -5^{\circ}\text{C}$ [23°F] for 5 consecutive minutes. 	<ol style="list-style-type: none"> ① Wrong piping connection between indoor unit and branch box ② Miswiring between indoor unit and branch box ③ Miswiring of LEV in branch box or indoor unit ④ Malfunction of LEV in branch box or indoor unit

●Diagnosis of defects

Make sure to turn the power OFF before connecting/disconnecting any connectors, or replacing boards.

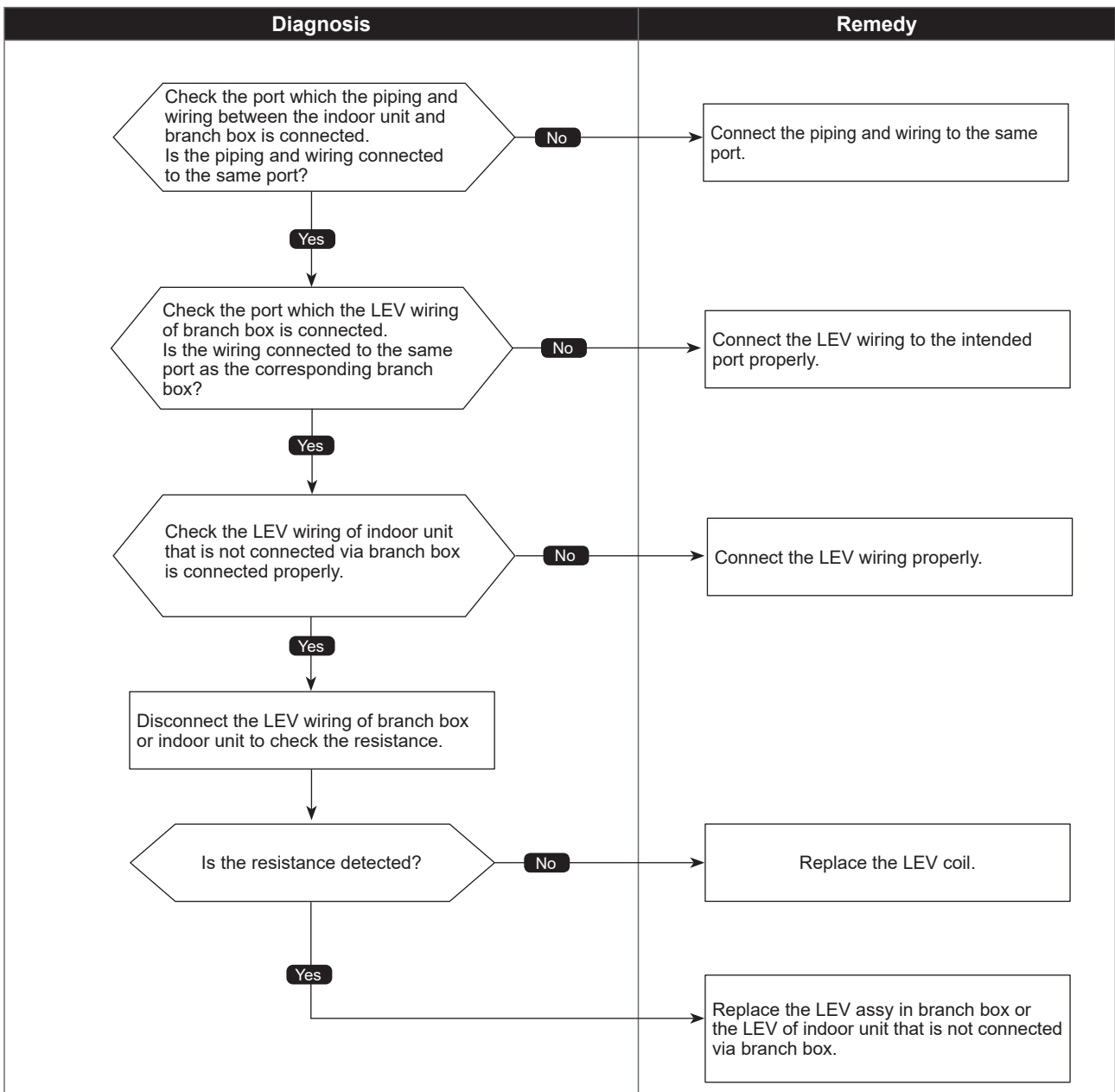

4-way valve trouble in heating mode

Abnormal points and detection methods	Causes and checkpoints
<p>If 4-way valve does not operate during heating operation.</p> <p>When any of the following temperature conditions is satisfied for 3 minutes or more during heating operation</p> <ol style="list-style-type: none"> 1. TH22j-TH21j $\leq -10^{\circ}\text{C}$ [-18°F] 2. TH23j-TH21j $\leq -10^{\circ}\text{C}$ [-18°F] 3. TH22j $\leq 3^{\circ}\text{C}$ [37.4°F] 4. TH23j $\leq 3^{\circ}\text{C}$ [37.4°F] <p>Note: For indoor unit, the abnormality is detected if an operating unit satisfies the condition.</p>	<ol style="list-style-type: none"> ① 4-way valve failure ② Disconnection or failure of 4-way valve coil ③ Clogged drain pipe ④ Disconnection or loose connection of connectors ⑤ Malfunction of input circuit on outdoor multi controller circuit board ⑥ Defective outdoor power circuit board <p>TH21: Indoor intake temperature thermistor (RT11 or TH1) TH22: Indoor liquid pipe temperature thermistor (RT13 or TH2) TH23: Indoor gas pipe temperature thermistor (TH-A to E)</p>

●Diagnosis of defects

Make sure to turn the power OFF before connecting/disconnecting any connectors, or replacing boards.

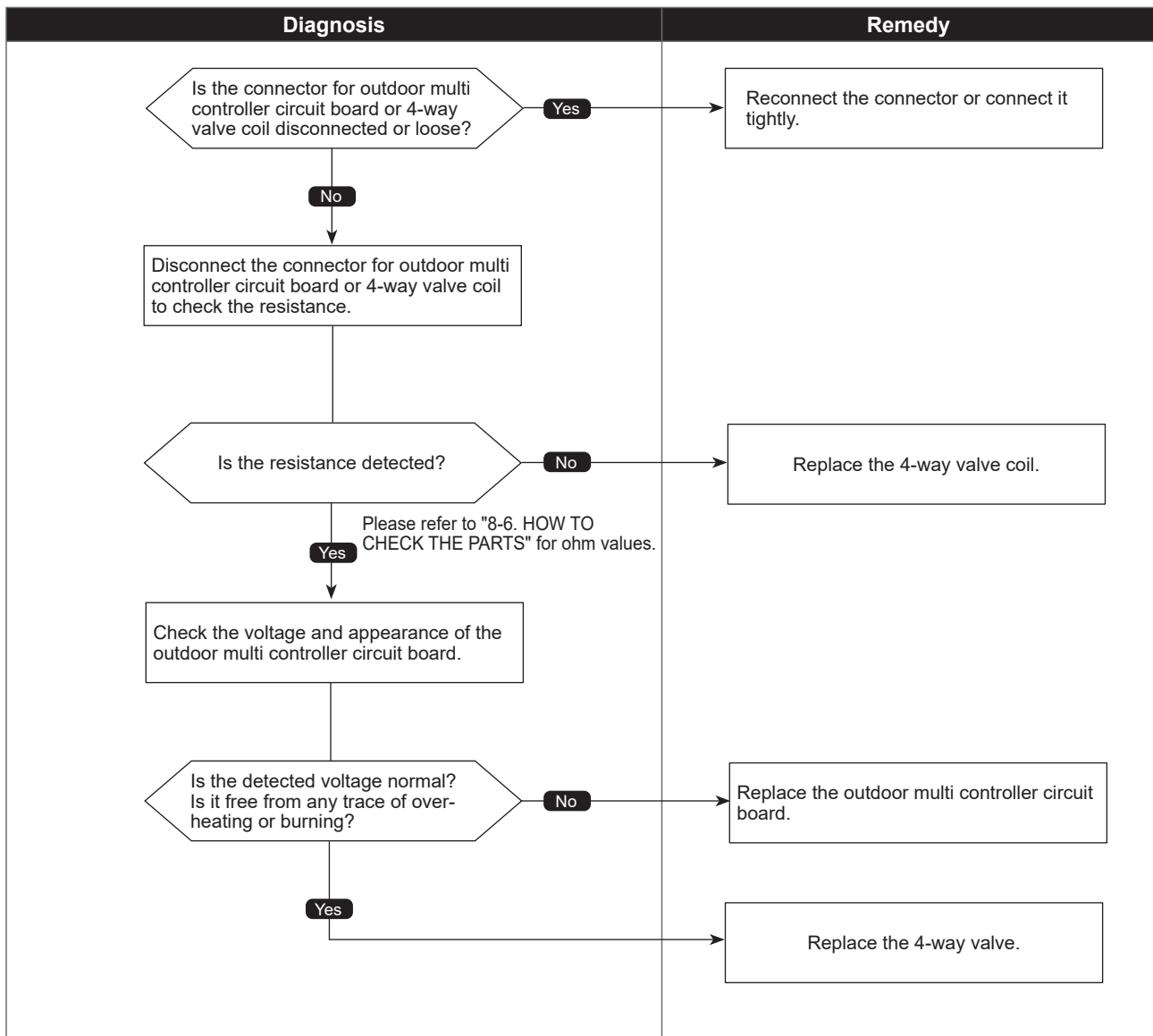

Compressor current interruption (Locked compressor)

Abnormal points and detection methods	Causes and checkpoints
If overcurrent of compressor is detected within 30 seconds since the compressor starts operating.	① Closed stop valve ② Decrease of power supply voltage ③ Looseness, disconnection or converse of compressor wiring connection ④ Incorrect DIP-SW setting of model selection on the outdoor controller board ⑤ Defective compressor ⑥ Defective outdoor power circuit board

●Diagnosis of defects

Make sure to turn the power OFF before connecting/disconnecting any connectors, or replacing boards.

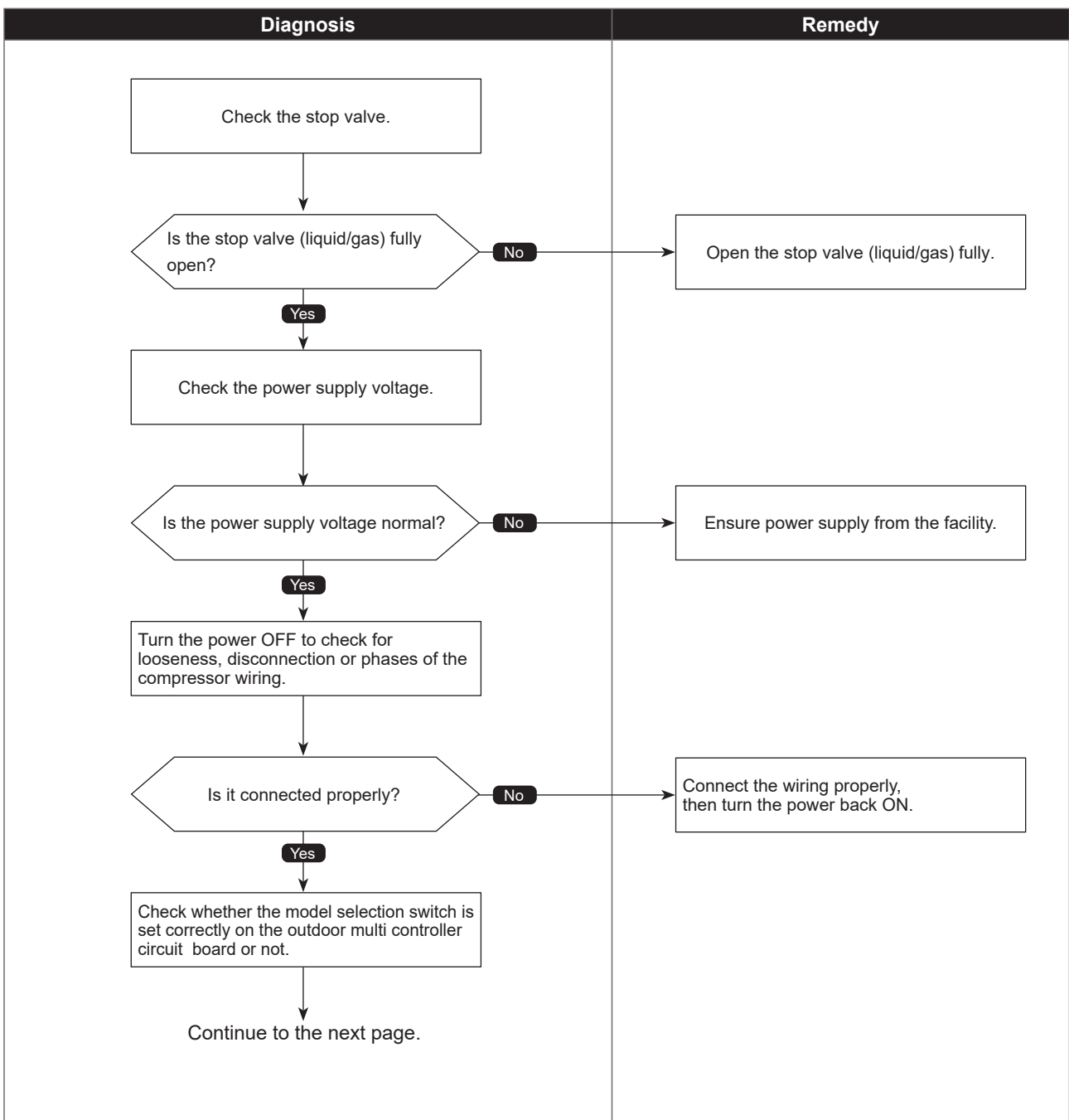

●Diagnosis of defects

Make sure to turn the power OFF before connecting/disconnecting any connectors, or replacing boards.

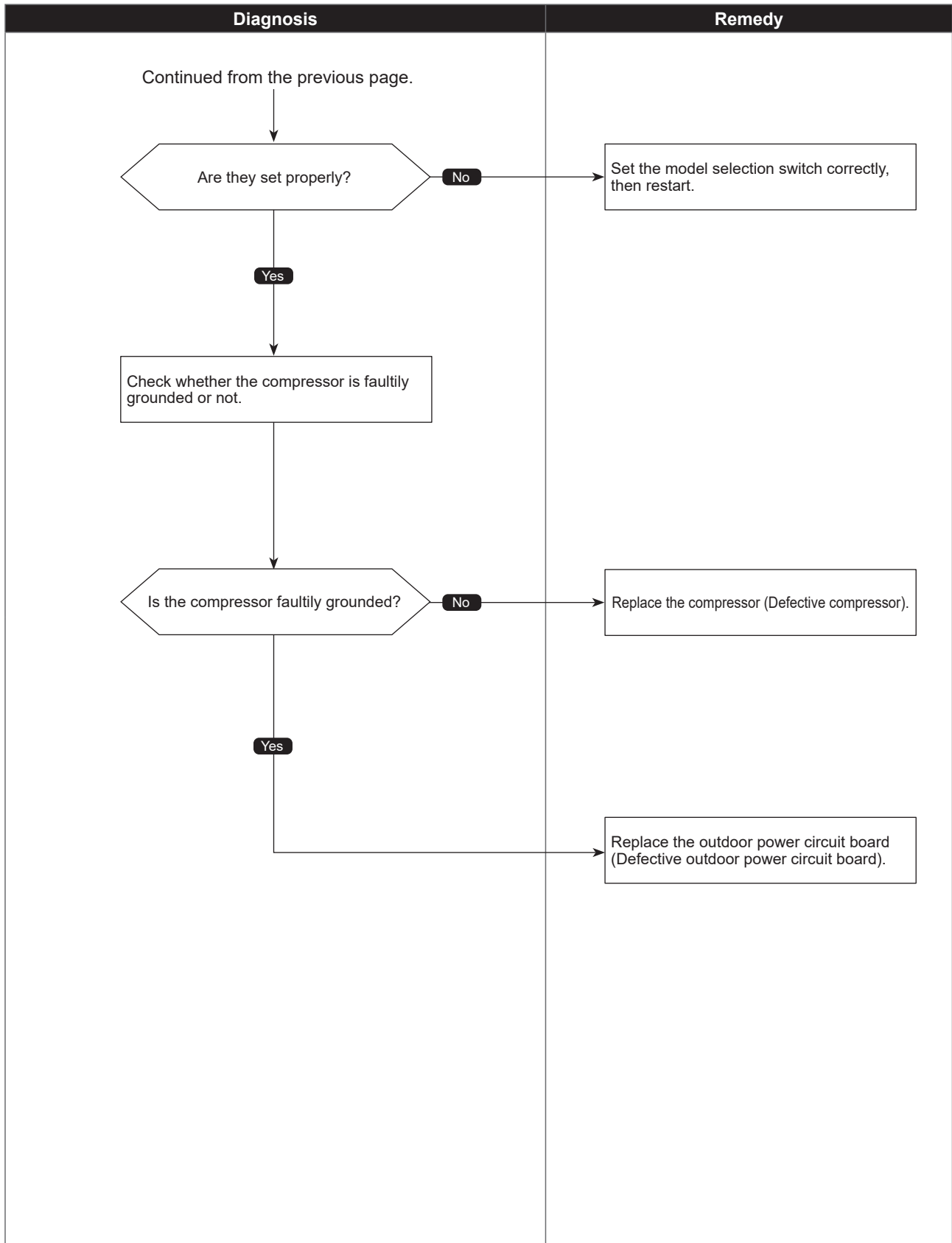

Compressor overcurrent interruption/failure in 12 VDC power supply circuit on power circuit board

Abnormal points and detection methods	Causes and checkpoints
<p>① If overcurrent of compressor is detected after 30 seconds since the compressor starts operating.</p> <p>② If 12 VDC power is not supplied from the 12 VDC supply circuit on the power circuit board.</p>	<p>① Closed outdoor stop valve</p> <p>② Decrease of power supply voltage</p> <p>③ Looseness, disconnection or reverse phase of compressor wiring connection</p> <p>④ Malfunction of indoor/outdoor fan</p> <p>⑤ Short-cycle of indoor/outdoor unit</p> <p>⑥ Model selection error upon replacement of outdoor multi controller circuit board</p> <p>⑦ Malfunction of input circuit on outdoor multi controller circuit board</p> <p>⑧ Defective compressor</p> <p>⑨ Defective outdoor power circuit board</p>

●Diagnosis of defects

Make sure to turn the power OFF before connecting/disconnecting any connectors, or replacing boards.

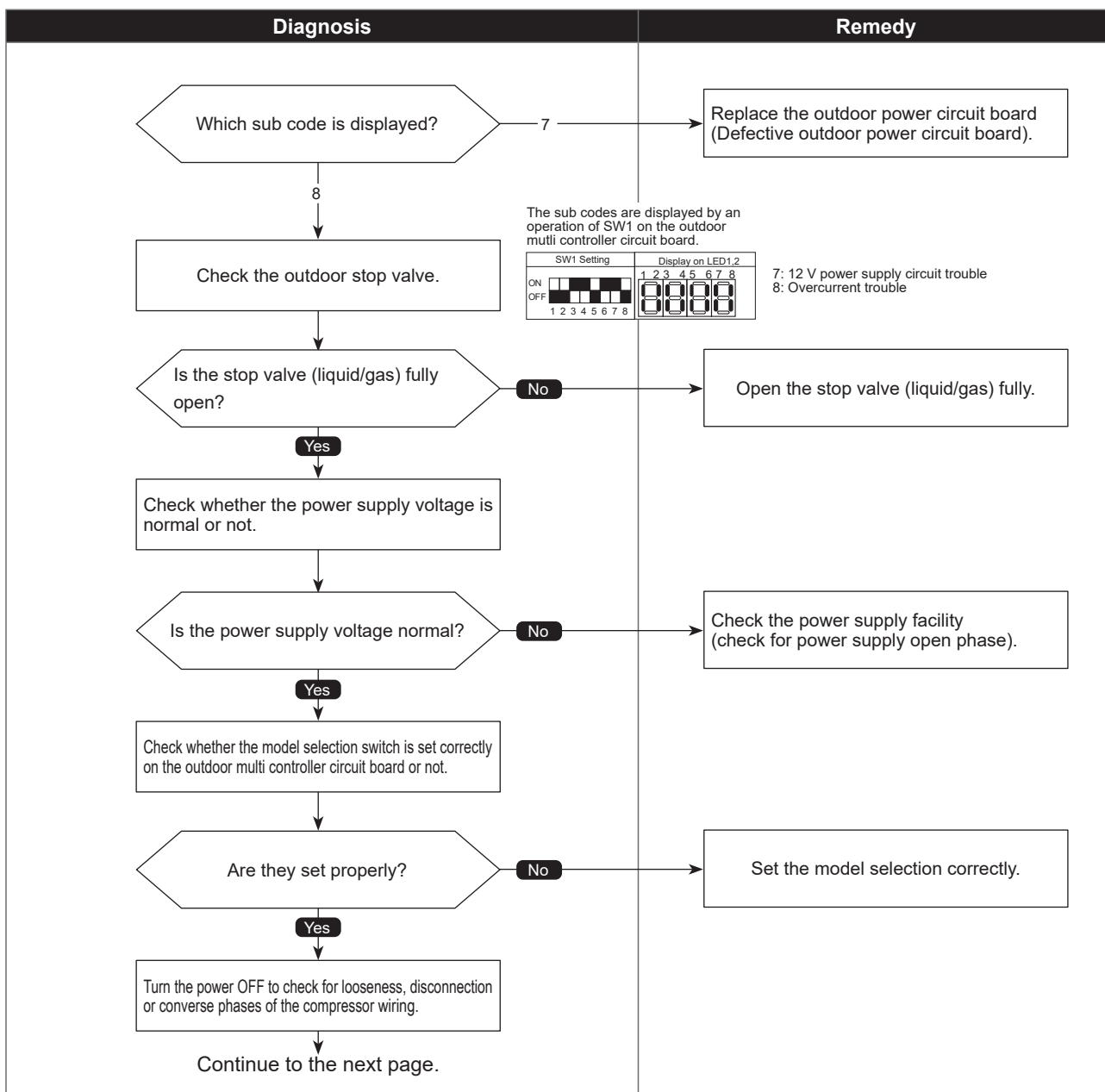

Compressor overcurrent interruption/failure in 12 VDC power supply circuit on power circuit board

●Diagnosis of defects

Make sure to turn the power OFF before connecting/disconnecting any connectors, or replacing boards.

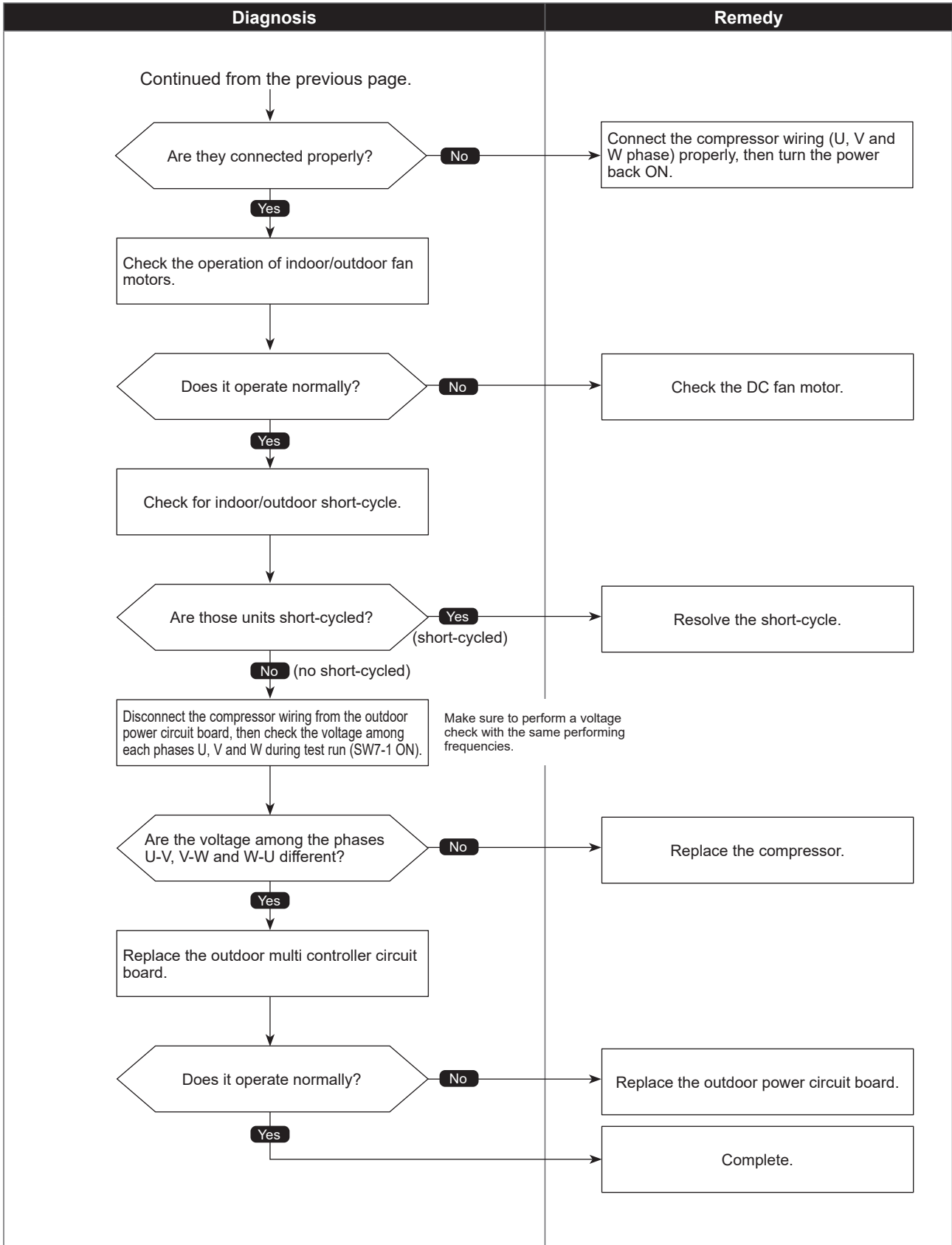

Voltage shortage /Overvoltage/PAM error/L1 open phase/ Primary current sensor error/Power synchronization signal error

Abnormal points and detection methods	Causes and checkpoints
<p>If any of following symptoms are detected;</p> <ul style="list-style-type: none"> ● Decrease of DC bus voltage to 200 V (Single-phase), 350 V (3-phase) ● Increase of DC bus voltage to 400 V (Single-phase), 760 V (3-phase) ● DC bus voltage stays at 310 V or less for consecutive 30 seconds when the operational frequency is over 20 Hz. ● When any of following conditions is satisfied while the detections value of primary current is 0.1 A or less. <ol style="list-style-type: none"> 1. The operational frequency is 40 Hz or more. 2. The compressor current is 6 A or more. 	<ol style="list-style-type: none"> ① Decrease/increase of power supply voltage ② L1 open-phase (3-phase only) ③ Primary current sensor failure ④ Disconnection of compressor wiring ⑤ Malfunction of 52C relay ⑥ Defective outdoor power circuit board ⑦ Malfunction of 52C relay driving circuit on outdoor multi controller circuit board ⑧ Disconnection of CN5 (3-phase only) ⑨ Disconnection of CN2 ⑩ Malfunction of primary current detecting circuit on outdoor power circuit board ⑪ Malfunction of resistor connected to 52C relay on outdoor power circuit board (3-phase only)

● **Diagnosis of defects**
Make sure to turn the power OFF before connecting/disconnecting any connectors, or replacing boards.

Single phase: single phase model
3-phase: three phase for wire model

The black square (■) indicates a switch position.

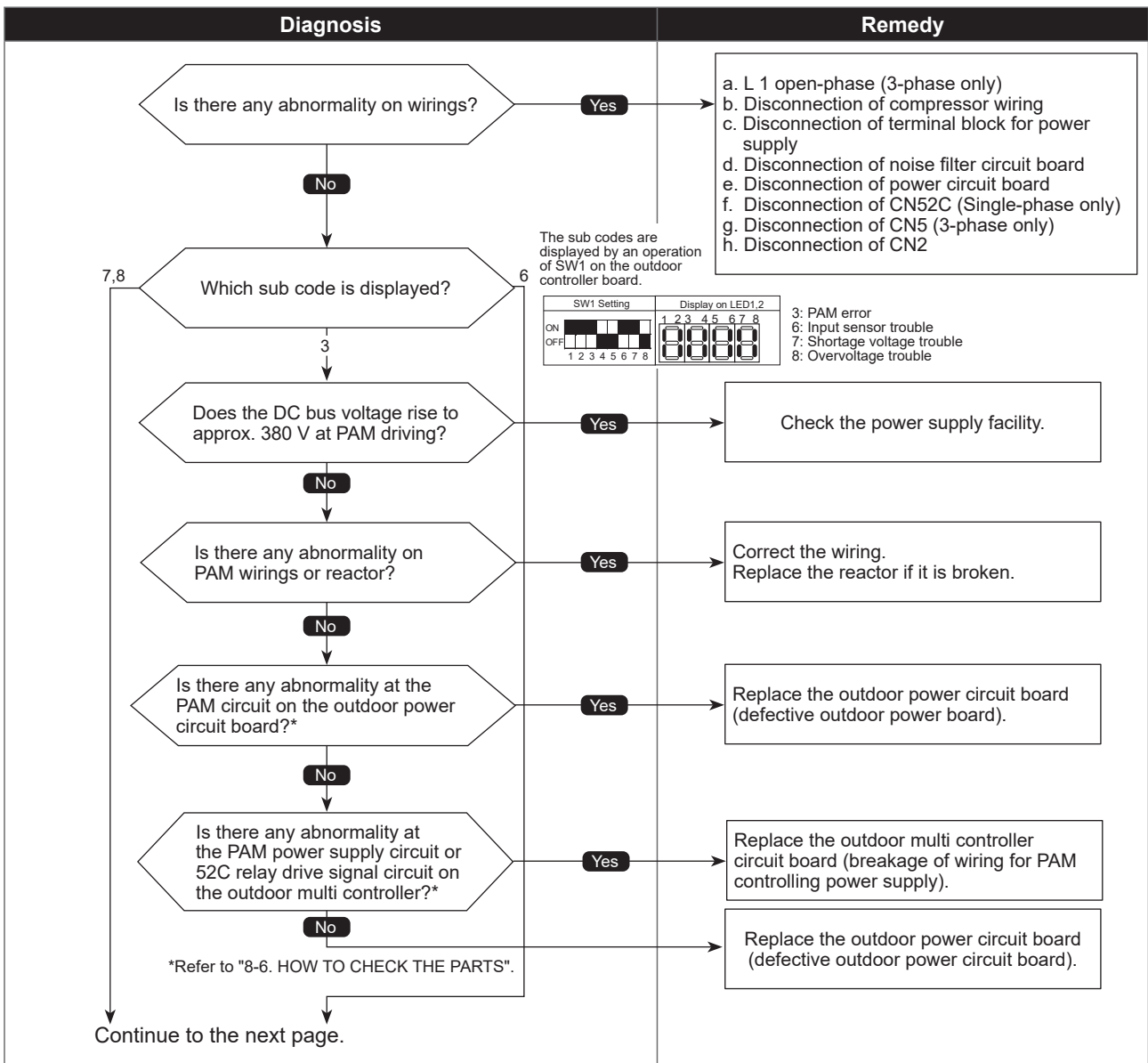

●Diagnosis of defects

Make sure to turn the power OFF before connecting/disconnecting any connectors, or replacing boards.

The black square (■) indicates a switch position.

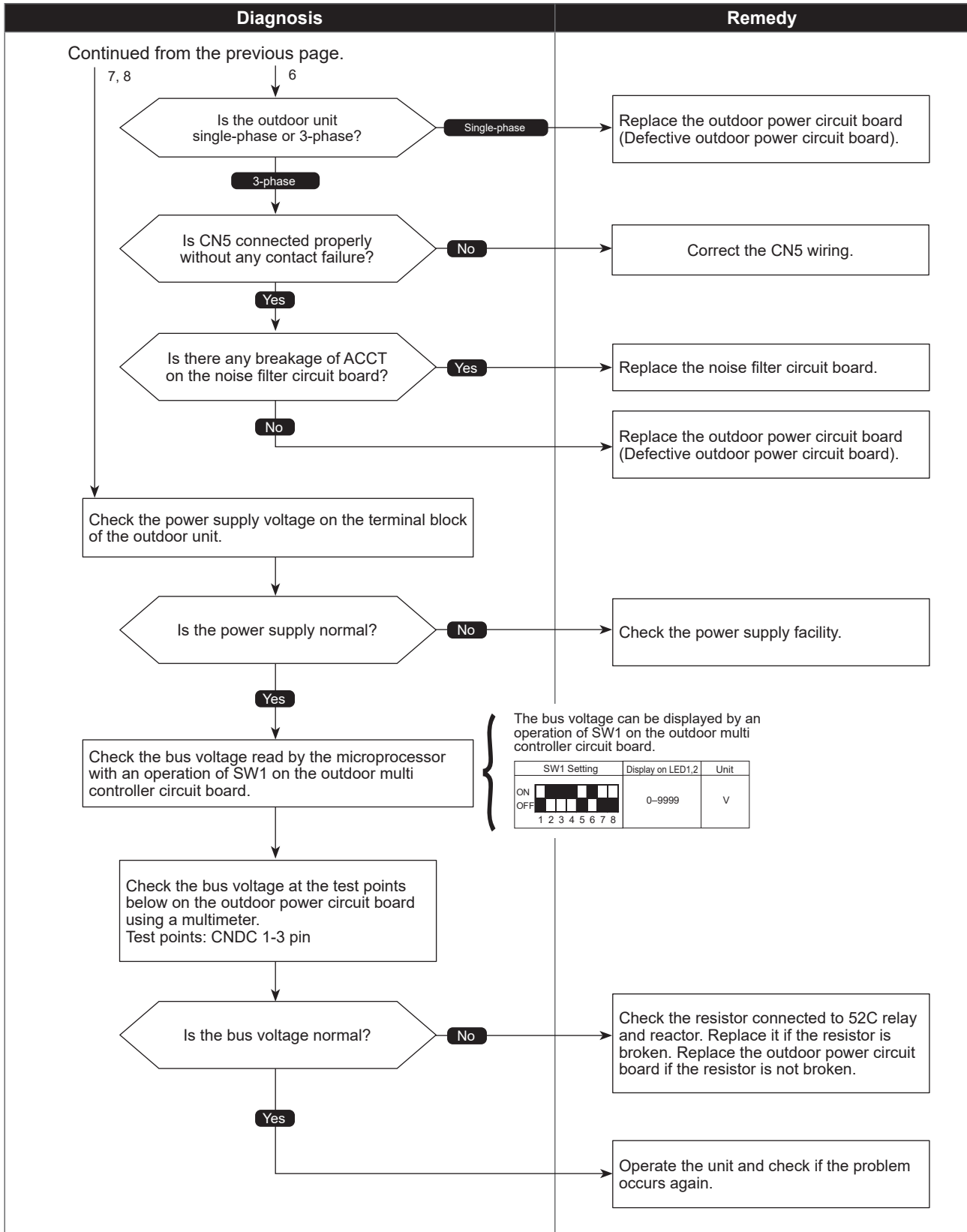

Check code

4230
(U5)

Heat sink temperature trouble

Abnormal points and detection methods	Causes and checkpoints
<p>If TH8 detects a temperature outside the specified range during compressor operation.</p> <p>TH8: Thermistor <Heat sink></p>	<ul style="list-style-type: none"> ① Blocked outdoor fan ② Malfunction of outdoor fan motor ③ Blocked airflow path ④ Rise of ambient temperature ⑤ Characteristic defect of thermistor ⑥ Malfunction of input circuit on outdoor power circuit board ⑦ Malfunction of outdoor fan driving circuit

●Diagnosis of defects

Make sure to turn the power OFF before connecting/disconnecting any connectors, or replacing boards.

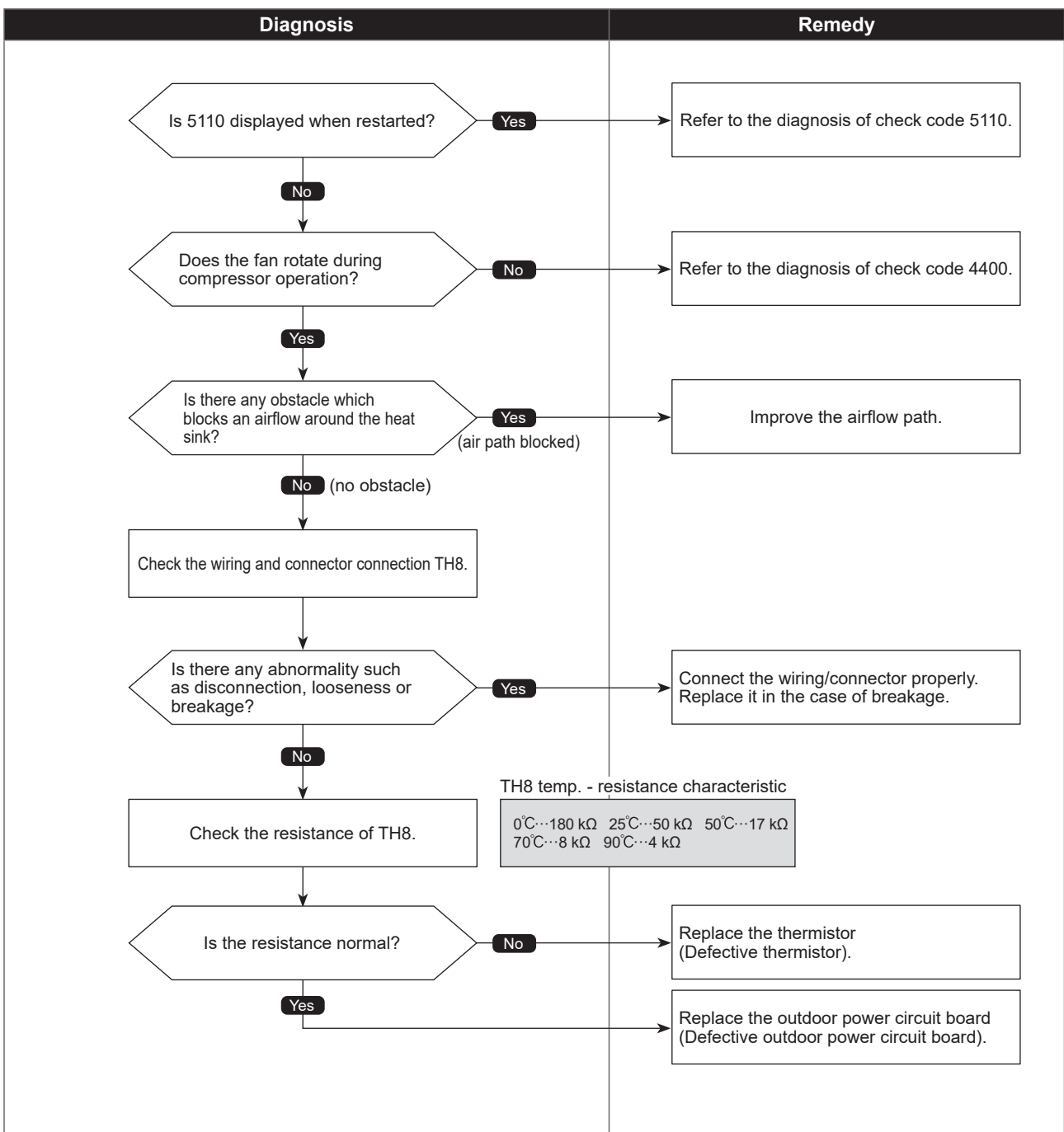

Check code

4250
(U6)

Power module trouble or overcurrent trouble

Abnormal points and detection methods	Causes and checkpoints
<p>If overcurrent of DC bus or compressor is detected 30 seconds after the compressor starts operating. To determine the source of abnormality, either the compressor or the power module, drive the power module forcibly.</p>	<ul style="list-style-type: none"> ① Closed outdoor stop valve ② Decrease of power supply voltage ③ Disconnection, looseness or conversed connection of compressor wiring ④ Defective compressor ⑤ Defective outdoor power circuit board

●Diagnosis of defects

Make sure to turn the power OFF before connecting/disconnecting any connectors, or replacing boards.

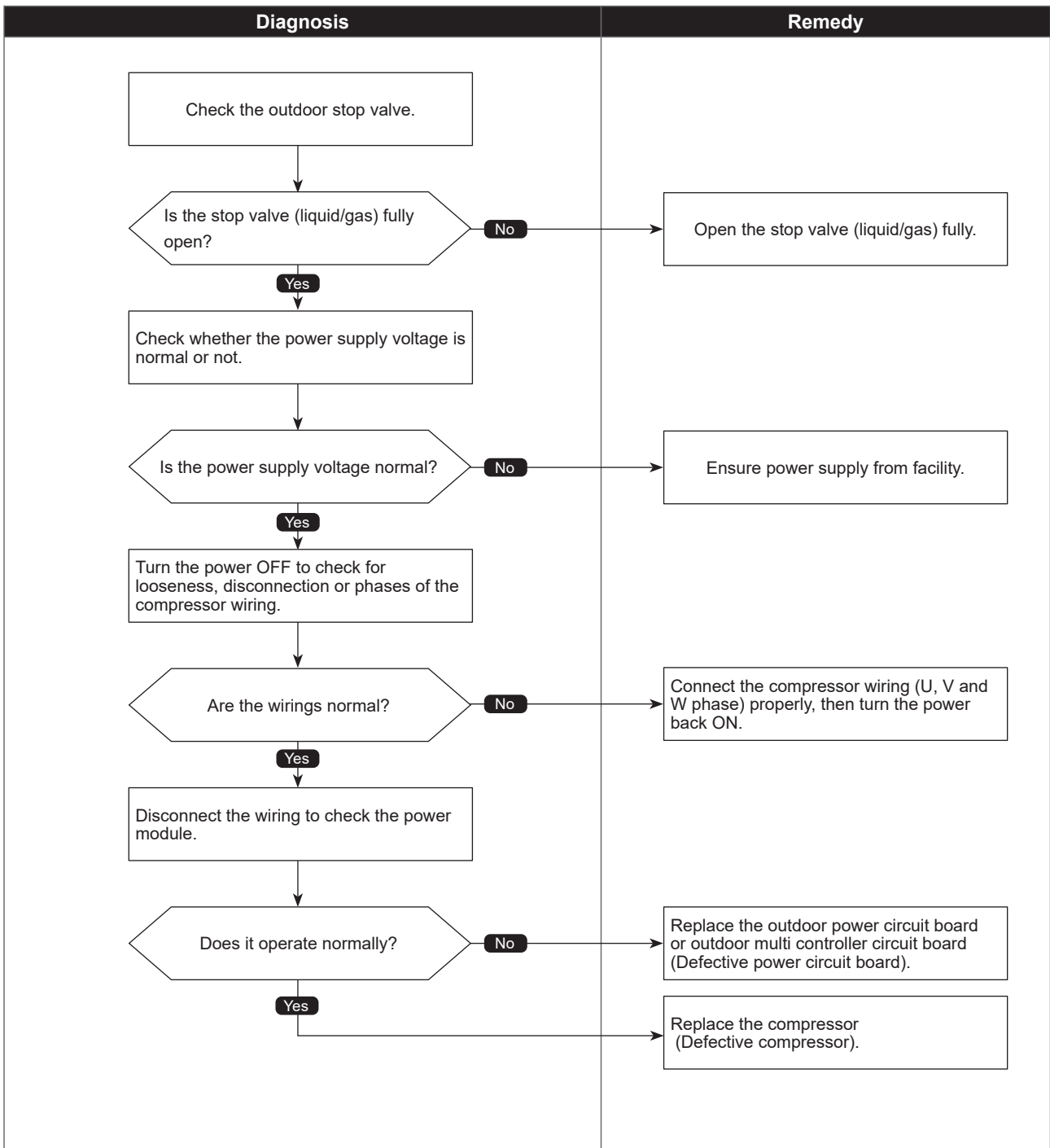

Check code

4400
(U8)

Fan trouble (Outdoor unit)

Abnormal points and detection methods	Causes and checkpoints
If no rotational frequency is detected, or detected a value outside the specified range during fan motor operation.	① Malfunction of fan motor ② Disconnection of CNF connector ③ Defective outdoor multi controller circuit board

●Diagnosis of defects

Make sure to turn the power OFF before connecting/disconnecting any connectors, or replacing boards.

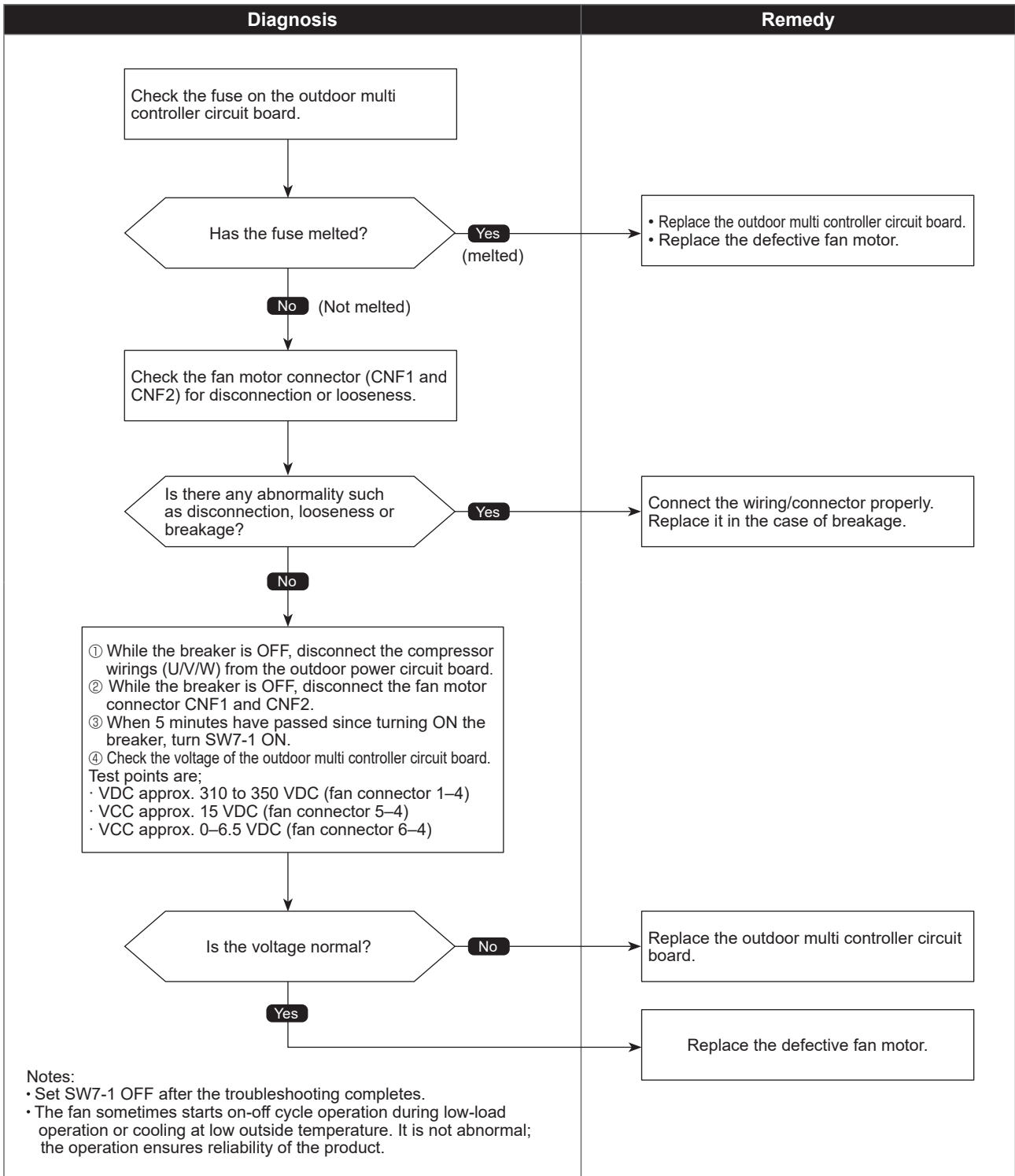

Check code

5101
(U3)

Compressor temperature thermistor (TH4) open/short

<Detected in outdoor unit>

Abnormal points and detection methods	Causes and checkpoints
If TH4 detects to be open/short. (The open/short detection is disabled for 10 minutes after compressor starts, during defrosting operation, or for 10 minutes after returning from the defrosting operation.) Open: 3°C or less Short: 217°C or more TH4: Thermistor <Compressor>	① Disconnection or contact failure of connectors ② Characteristic defect of thermistor ③ Defective outdoor multi controller circuit board

●Diagnosis of defects

Make sure to turn the power OFF before connecting/disconnecting any connectors, or replacing boards.

The black square (■) indicates a switch position.

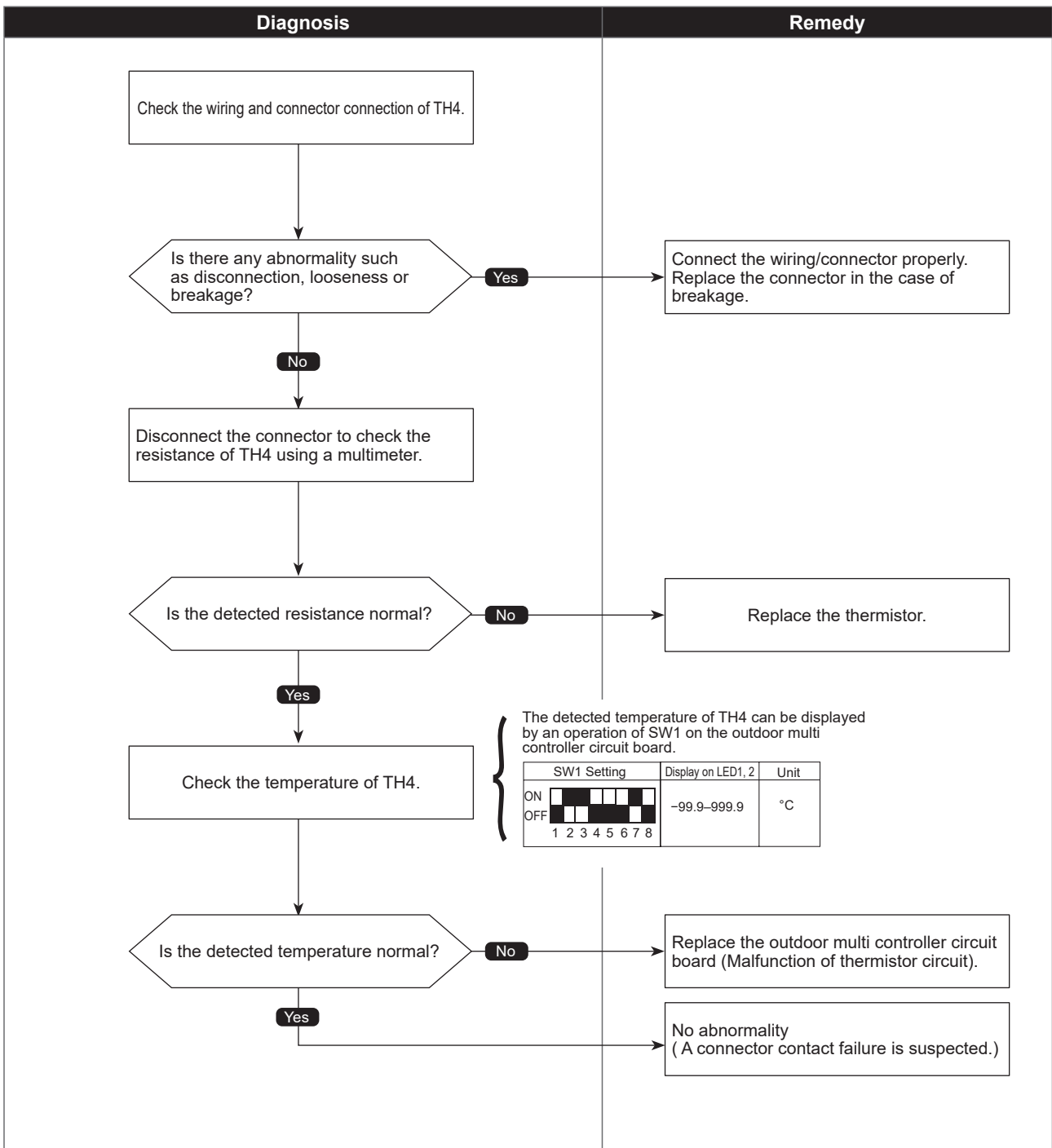

Suction pipe temperature thermistor (TH6) open/short

<Detected in outdoor unit>

Abnormal points and detection methods	Causes and checkpoints
<p>If TH6 detects to be open/short. (The open/short detection is disabled during 10 seconds to 10 minutes after compressor starts, during defrosting operation, or for 10 minutes after returning from the defrosting operation.) Open: -40°C or less Short: 90°C or more TH6: Thermistor <Suction pipe></p>	<p>① Disconnection or contact failure of connectors ② Characteristic defect of thermistor ③ Defective outdoor multi controller circuit board</p>

●Diagnosis of defects

Make sure to turn the power OFF before connecting/disconnecting any connectors, or replacing boards.

The black square (■) indicates a switch position.

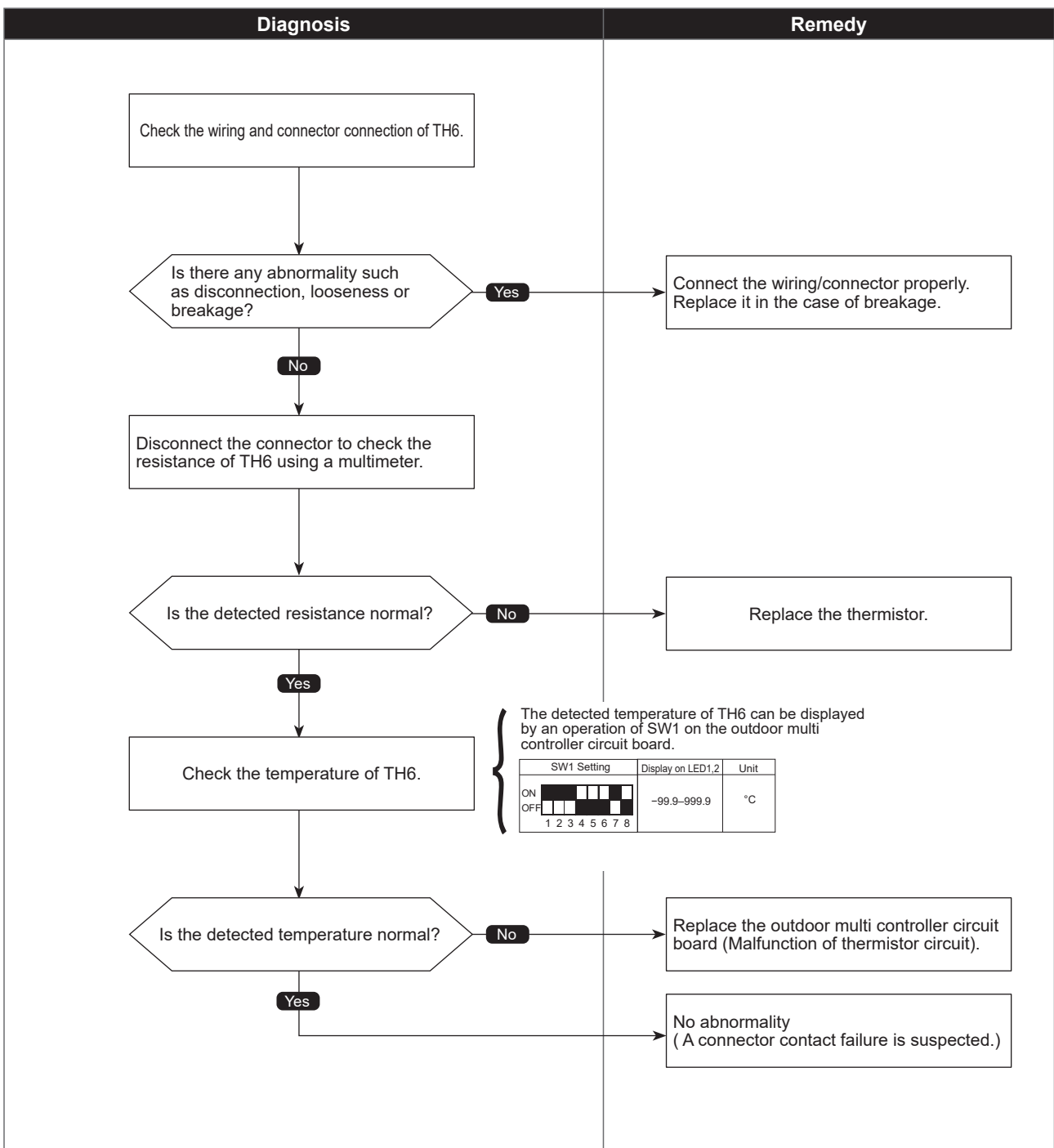

Check code

5105
(U4)

Outdoor liquid pipe temperature thermistor (TH3) open/short

Abnormal points and detection methods	Causes and checkpoints
<p>If TH3 detects to be open/short. (The open/short detection is disabled during 10 seconds to 10 minutes after compressor starts, during defrosting operation, or for 10 minutes after returning from the defrosting operation.) Open: -40°C or less Short: 90°C or more TH3: Thermistor <Outdoor liquid pipe></p>	<p>① Disconnection or contact failure of connectors ② Characteristic defect of thermistor ③ Defective outdoor multi controller circuit board</p>

●Diagnosis of defects

Make sure to turn the power OFF before connecting/disconnecting any connectors, or replacing boards.

The black square (■) indicates a switch position.

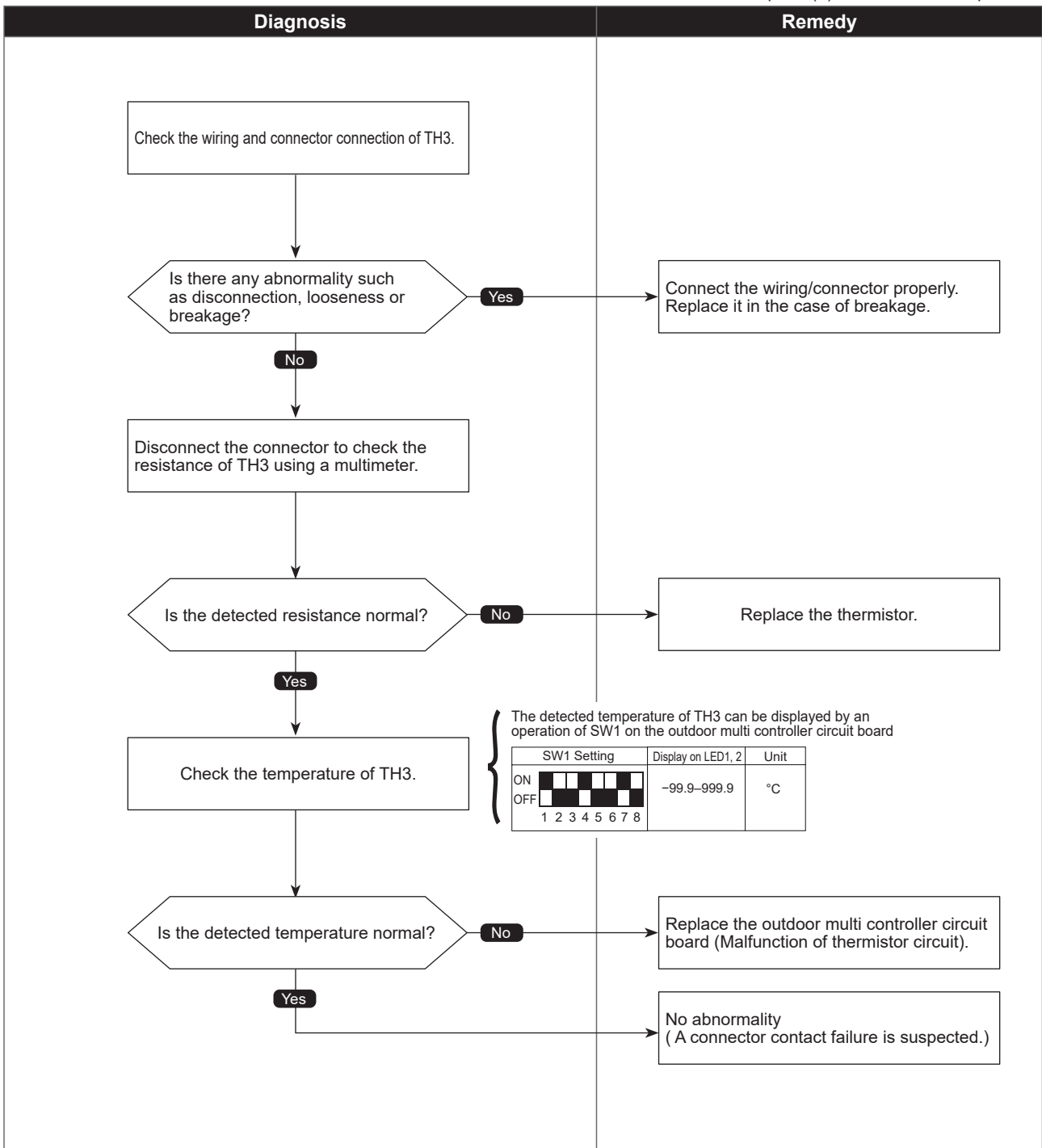

Check code

5106
(U4)

Ambient temperature thermistor (TH7) open/short

Abnormal points and detection methods	Causes and checkpoints
If TH7 detects to be open/short. Open: -40°C or less Short: 90°C or more TH7: Thermistor <Ambient>	① Disconnection or contact failure of connectors ② Characteristic defect of thermistor ③ Defective outdoor multi controller circuit board

●Diagnosis of defects

Make sure to turn the power OFF before connecting/disconnecting any connectors, or replacing boards.

The black square (■) indicates a switch position.

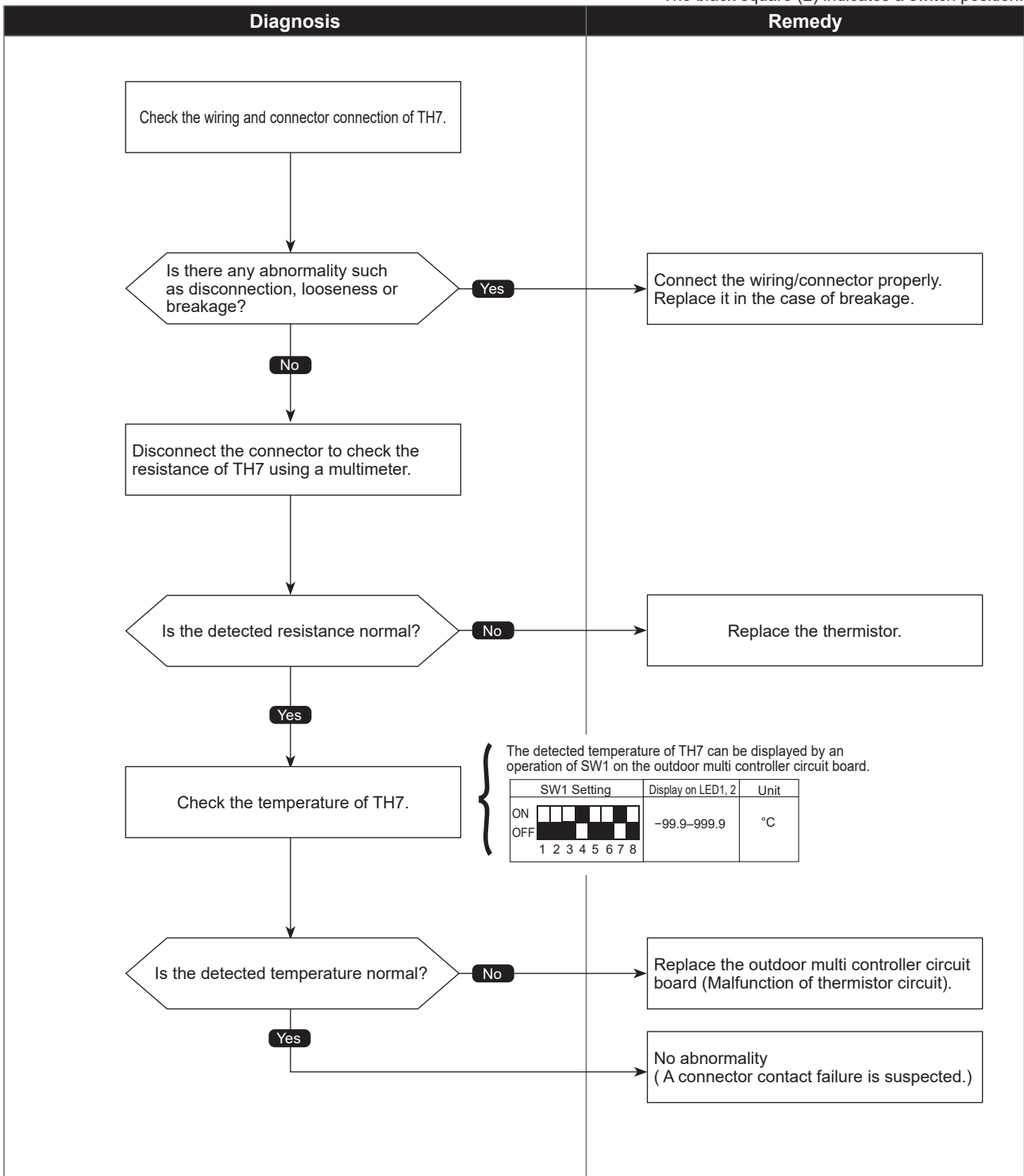

HIC pipe temperature thermistor (TH2) open/short

Abnormal points and detection methods	Causes and checkpoints
If TH2 detects to be open/short. Open: -40°C or less Short: 90°C or more TH2: Thermistor <HIC pipe>	① Disconnection or contact failure of connectors ② Characteristic defect of thermistor ③ Defective outdoor multi controller circuit board

●Diagnosis of defects

Make sure to turn the power OFF before connecting/disconnecting any connectors, or replacing boards.

The black square (■) indicates a switch position.

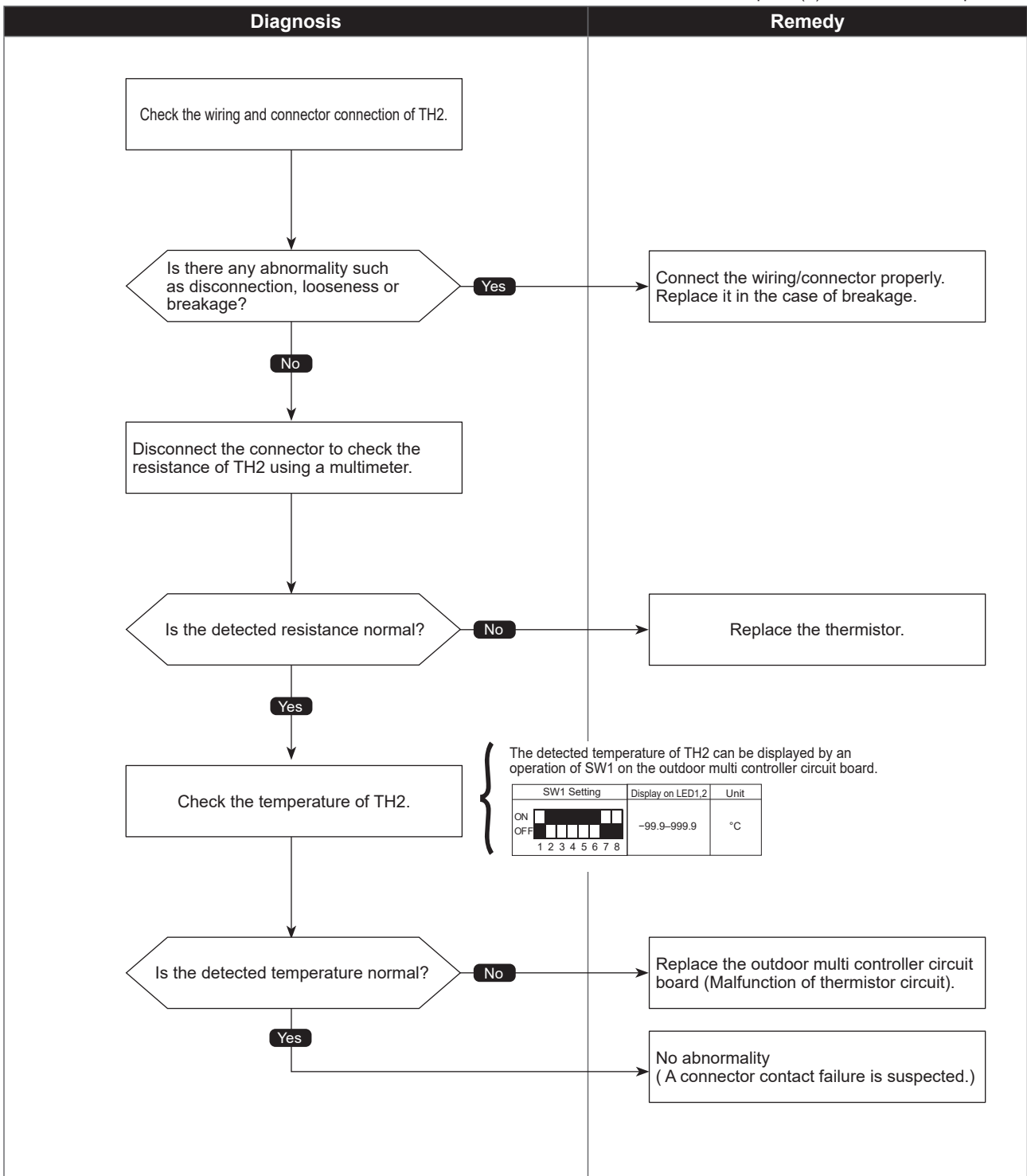

Check code

5110
(U4)

Heat sink temperature thermistor(TH8) open/short

Abnormal points and detection methods	Causes and checkpoints
If TH8 (Internal thermistor) detects to be open/short. Open: -34.8°C or less Short: 102°C or more TH8: Thermistor <Heat sink>	① Disconnection or contact failure of connectors ② Characteristic defect of thermistor ③ Defective outdoor multi controller circuit board

●Diagnosis of defects

Make sure to turn the power OFF before connecting/disconnecting any connectors, or replacing boards.

The black square (■) indicates a switch position.

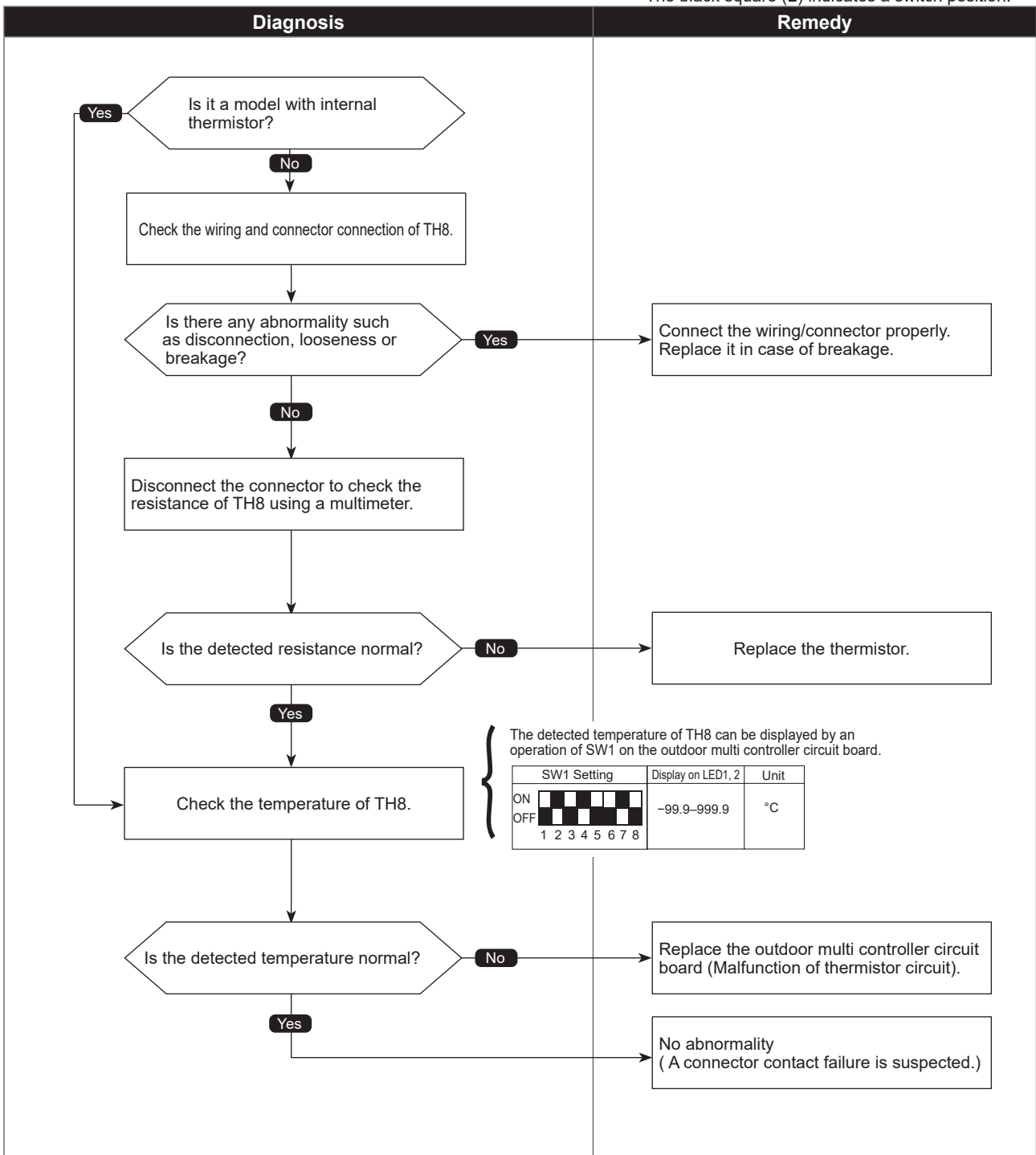

Check code

5201
(F5)

High pressure sensor (63HS) trouble

Abnormal points and detection methods	Causes and checkpoints
<p>① When the detected pressure in the high pressure sensor is 1kgf/cm² or less during operation, the compressor stops operation and enters into an anti-restart mode for 3 minutes.</p> <p>② When the detected pressure is 1kgf/cm² or less immediately before restarting, the compressor falls into an abnormal stop with check code <5201>.</p> <p>③ For 3 minutes after compressor restarting, during defrosting operation, and for 3 minutes after returning from defrosting operation, above mentioned symptoms are not determined as abnormal.</p>	<p>① Defective high pressure sensor</p> <p>② Decrease of internal pressure caused by gas leakage</p> <p>③ Disconnection or contact failure of connector</p> <p>④ Malfunction of input circuit on outdoor multi controller circuit board</p>

●Diagnosis of defects

Make sure to turn the power OFF before connecting/disconnecting any connectors, or replacing boards.

The black square (■) indicates a switch position.

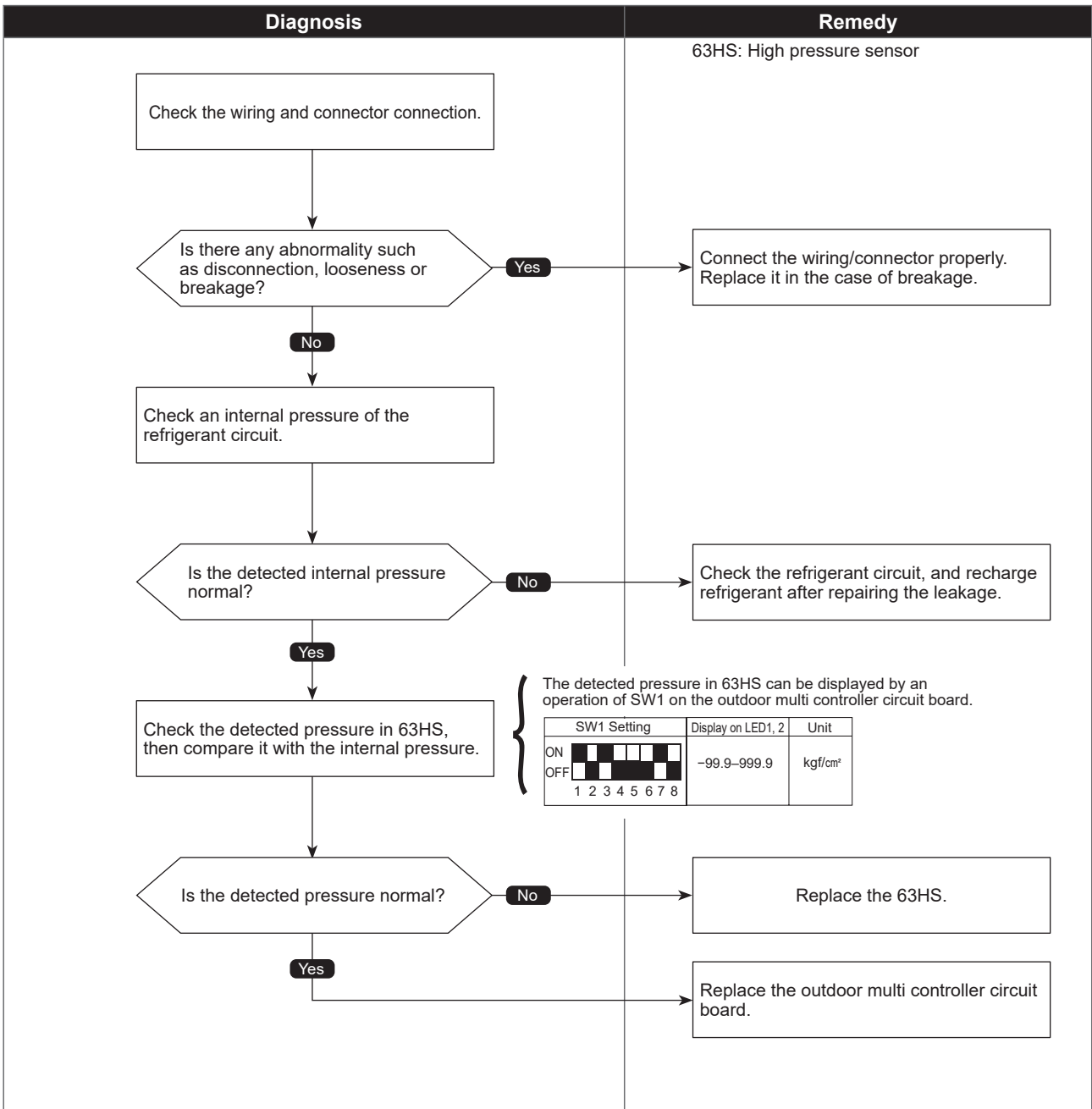

Check code

5202
(F3)

Low pressure sensor (63LS) trouble

Abnormal points and detection methods	Causes and checkpoints
<p>① When the detected pressure in the low pressure sensor is -2.3kgf/cm^2 or less, or 23.1kgf/cm^2 or more during operation, the compressor stops operation with check code <5202>.</p> <p>② For 3 minutes after compressor restarting, during defrosting operation, and for 3 minutes after returning from defrosting operation, above mentioned symptoms are not determined as abnormal.</p>	<p>① Defective low pressure sensor</p> <p>② Decrease of internal pressure caused by gas leakage</p> <p>③ Disconnection or contact failure of connector</p> <p>④ Malfunction of input circuit on outdoor multi controller circuit board</p>

●Diagnosis of defects

Make sure to turn the power OFF before connecting/disconnecting any connectors, or replacing boards.

The black square (■) indicates a switch position.

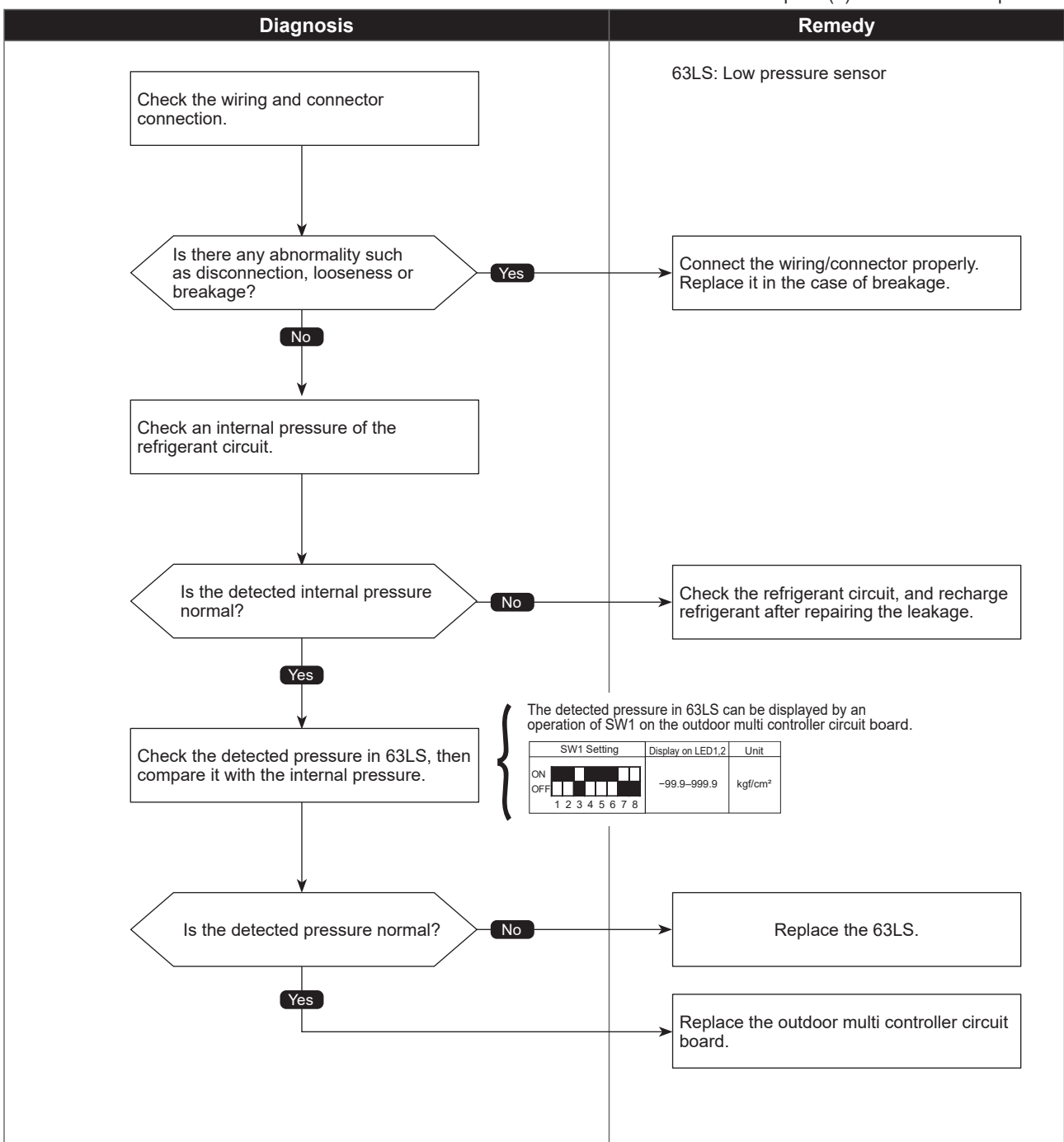

Check code

5300
(UH)

Current sensor trouble

Abnormal points and detection methods	Causes and checkpoints
If the detected current sensor input value (primary current) during compressor operation is outside the specified range.	① Decrease/trouble of power supply voltage ② Disconnection of compressor wiring ③ Input sensor trouble on outdoor power circuit board

●Diagnosis of defects

Make sure to turn the power OFF before connecting/disconnecting any connectors, or replacing boards.

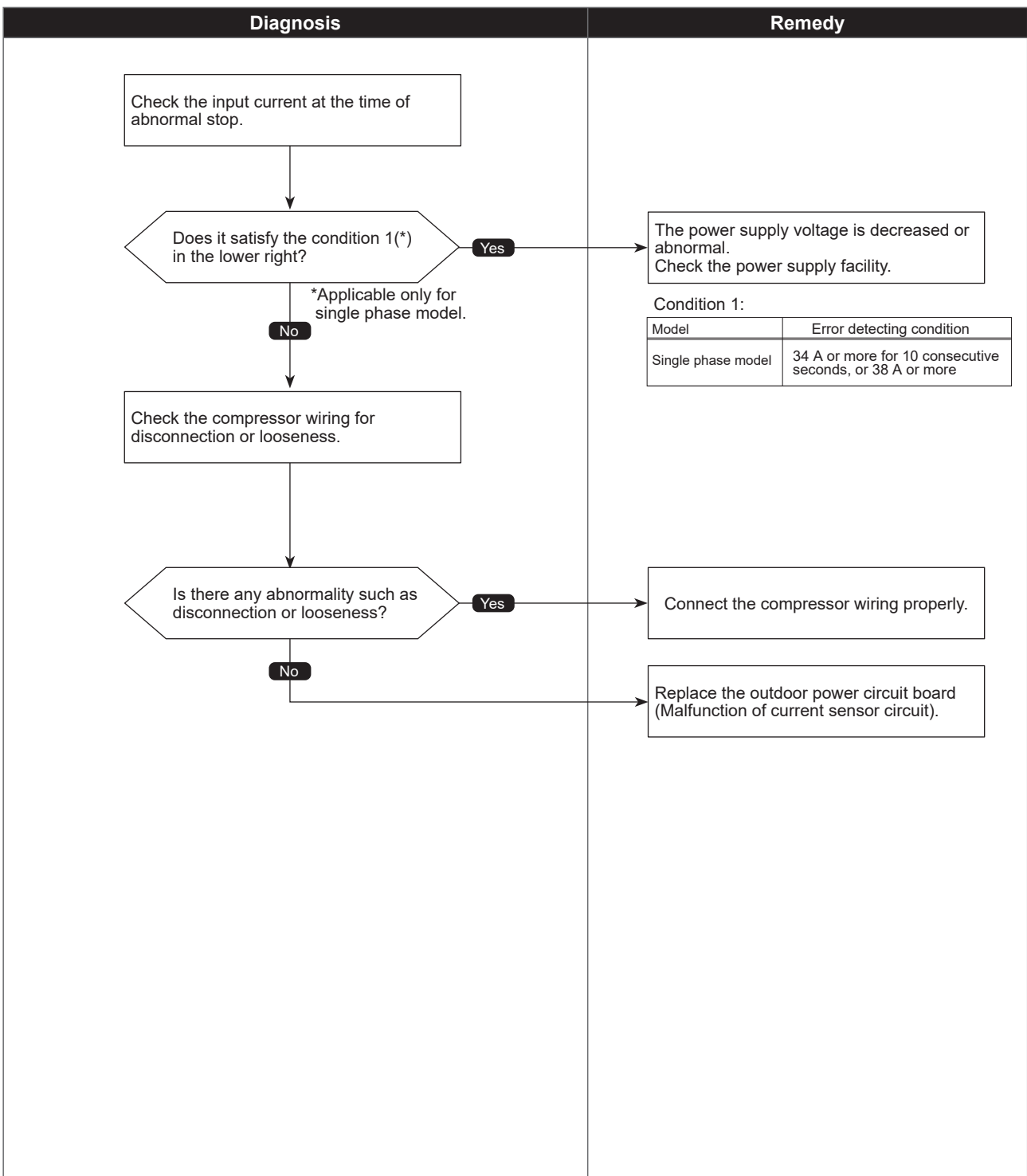

Check code

6600
(A0)

Duplex address error

Abnormal points and detection methods	Causes and checkpoints
If 2 or more units with the same address are exist.	① There are 2 units or more with the same address in their controller among outdoor unit, indoor unit, Fresh Master, Lossnay or remote controller ② Noise interference on indoor/outdoor connectors

●Diagnosis of defects

Make sure to turn the power OFF before connecting/disconnecting any connectors, or replacing boards.

Diagnosis	Remedy
<pre> graph TD A[Search for a unit with the same address as the source of abnormality.] --> B{Is there any unit with the same address?} B -- Yes --> R1[Correct the address, and turn the power OFF of indoor/outdoor unit, Fresh Master or Lossnay simultaneously for 2 minutes or more, then turn the power back ON.] B -- No --> C[Turn the power back ON.] C --> D{Does it operate normally?} D -- No --> R2[Malfunction of sending/receiving circuit on indoor/outdoor unit is suspected. Check the transmission pulse and noise on transmission wiring.] D -- Yes --> R3[There is no abnormality on the AC unit. It might be caused by an external noise, so check the transmission line to remove the factor(s).] </pre>	<p>Correct the address, and turn the power OFF of indoor/outdoor unit, Fresh Master or Lossnay simultaneously for 2 minutes or more, then turn the power back ON.</p> <p>Malfunction of sending/receiving circuit on indoor/outdoor unit is suspected. Check the transmission pulse and noise on transmission wiring.</p> <p>There is no abnormality on the AC unit. It might be caused by an external noise, so check the transmission line to remove the factor(s).</p>

Check code

6602
(A2)

Transmission processor hardware error

Abnormal points and detection methods	Causes and checkpoints
If the transmission line shows "1" although the transmission processor transmitted "0".	<ul style="list-style-type: none"> ① A transmitting data collision occurred because of a wiring work or polarity change has performed while the power is ON on either of the indoor/outdoor unit, Fresh Master or Lossnay ② Malfunction of transmitting circuit on transmission processor ③ Noise interference on indoor/outdoor connectors

●Diagnosis of defects

Make sure to turn the power OFF before connecting/disconnecting any connectors, or replacing boards.

Diagnosis	Remedy
<pre> graph TD A{{A wiring work was performed while the power OFF.}} -- No --> B[If the wiring work was performed while the power ON, turn the power OFF of indoor/outdoor unit, Fresh Master or Lossnay simultaneously for 2 minutes or more, then turn the power back ON.] A -- Yes --> C[Turn the power back ON.] C --> D{{Does it operate normally?}} D -- No --> E[Replace the indoor/outdoor controller board.] D -- Yes --> F[There is no abnormality on the AC unit. It might be caused by an external noise, so check the transmission line to remove the factor(s).] </pre>	<div style="border: 1px solid black; padding: 5px; margin-bottom: 10px;"> <p>If the wiring work was performed while the power ON, turn the power OFF of indoor/outdoor unit, Fresh Master or Lossnay simultaneously for 2 minutes or more, then turn the power back ON.</p> </div> <div style="border: 1px solid black; padding: 5px; margin-bottom: 10px;"> <p>Replace the indoor/outdoor controller board.</p> </div> <div style="border: 1px solid black; padding: 5px;"> <p>There is no abnormality on the AC unit. It might be caused by an external noise, so check the transmission line to remove the factor(s).</p> </div>

Transmission bus BUSY error

Abnormal points and detection methods	Causes and checkpoints
<p>① An abnormality when no transmission status caused by transmitting data collision continues for 8 to 10 minutes.</p> <p>② An abnormality when data cannot be output on the transmission line consecutively because of noise etc. for 8 to 10 minutes.</p>	<p>① The transmission processor is unable to transmit due to a short-cycle voltage such as noise is mixed on the transmission line.</p> <p>② The transmission processor is unable to transmit due to an increase of transmission data amount caused by a miswiring of the terminal block (transmission line) (TB3) and the terminal block (centralized control line) (TB7) on the outdoor unit.</p> <p>③ The share on transmission line becomes high due to a mixed transmission caused by a malfunction of repeater on the outdoor unit, which is a function to connect/disconnect transmission from/to control system and centralized control system.</p>

●Diagnosis of defects

Make sure to turn the power OFF before connecting/disconnecting any connectors, or replacing boards.

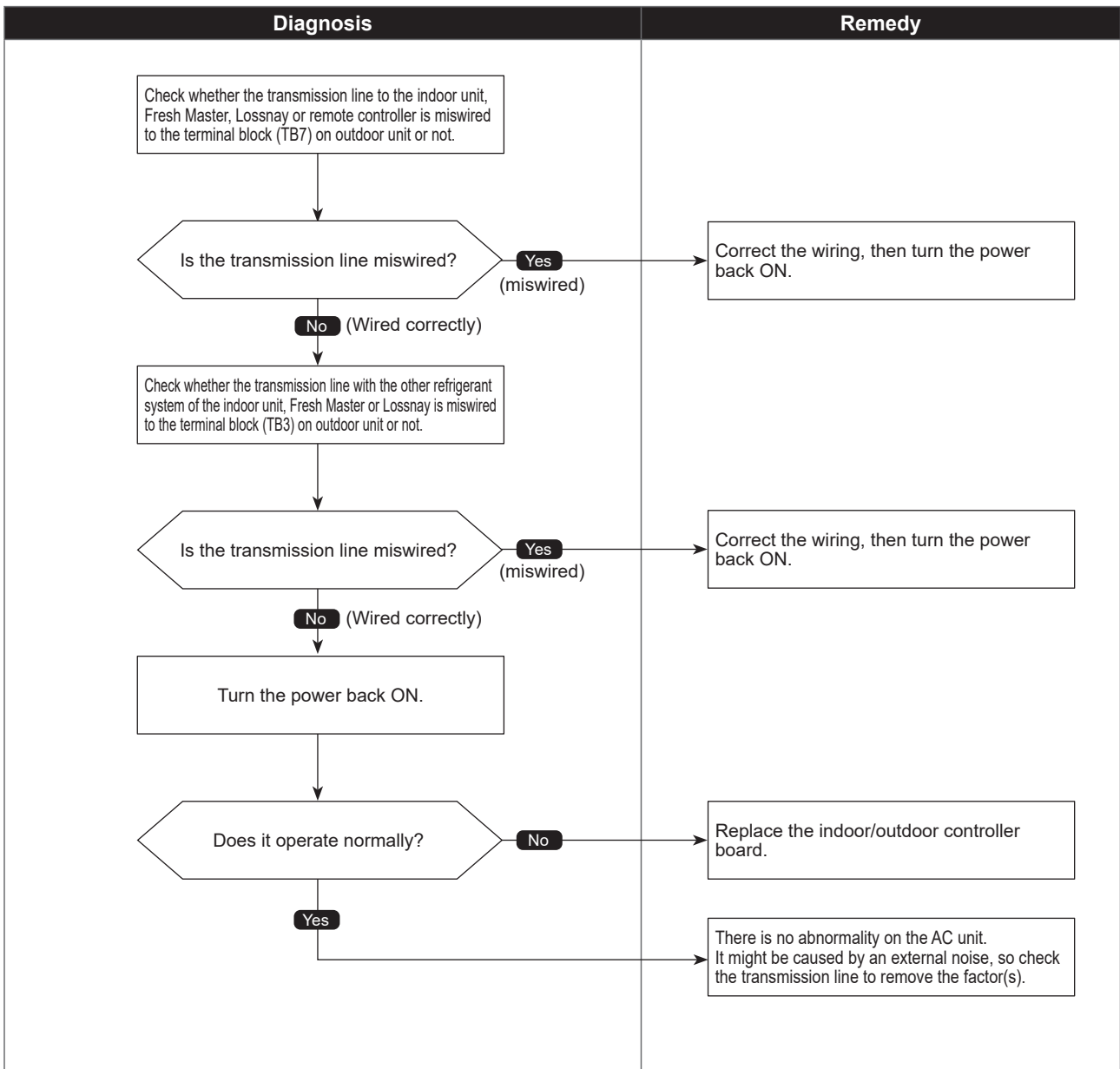

Check code

6606
(A6)

Signal communication error with transmission processor

Abnormal points and detection methods	Causes and checkpoints
<p>① If the data of unit/transmission processor were not normally transmitted.</p> <p>② If the address transmission from the unit processor was not normally transmitted.</p>	<p>① Accidental disturbance such as noise or lightning surge</p> <p>② Hardware malfunction of transmission processor</p>

●Diagnosis of defects

Make sure to turn the power OFF before connecting/disconnecting any connectors, or replacing boards.

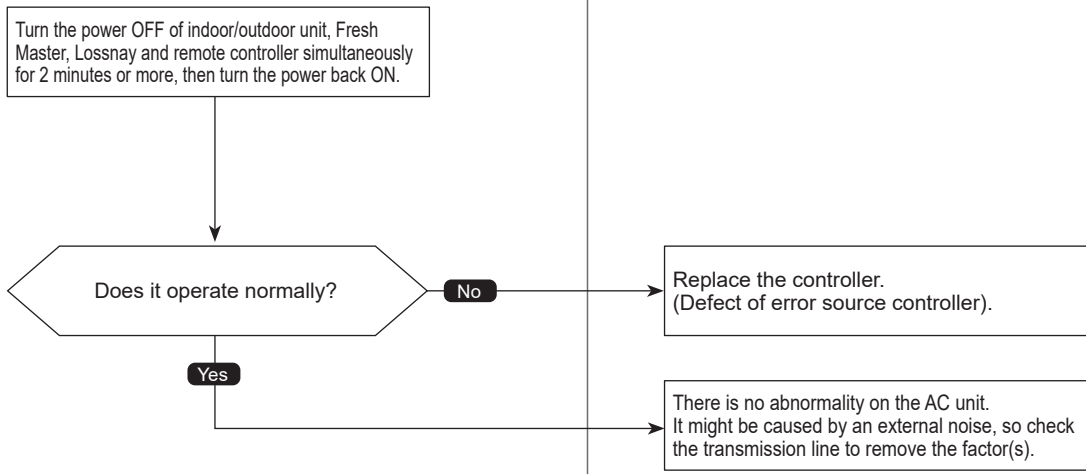
Diagnosis	Remedy
 <pre>graph TD; A[Turn the power OFF of indoor/outdoor unit, Fresh Master, Lossnay and remote controller simultaneously for 2 minutes or more, then turn the power back ON.] --> B{Does it operate normally?}; B -- No --> C[Replace the controller. (Defect of error source controller).]; B -- Yes --> D[There is no abnormality on the AC unit. It might be caused by an external noise, so check the transmission line to remove the factor(s).];</pre>	

Abnormal points and detection methods	Causes and checkpoints
<p>① Represents a common error detection An abnormality detected by the sending side controller when receiving no ACK from the receiving side, though signal was once sent. The sending side searches the error in 30 seconds interval for 6 times continuously.</p>	<p>① The previous address unit does not exist since the address switch was changed while in electric continuity status. ② Decline of transmission voltage/signal caused by tolerance over on transmission line ·At the furthest end: 200 m ·On remote controller line: (12 m) ③ Decline of transmission voltage/signal due to unmatched transmission line types ·Types for shield line: CVVS, CPEVS or MVVS ·Line diameter: 1.25 mm² or more ④ Decline of transmission voltage/signal due to excessive number of connected units ⑤ Malfunction due to accidental disturbance such as noise or lightning surge ⑥ Defect of error source controller</p>
<p>② The cause of displayed address and attribute is on the outdoor unit side An abnormality detected by the indoor unit if receiving no ACK when transmitting signal from the indoor unit to the outdoor unit.</p>	<p>① Contact failure of indoor/outdoor unit transmission line ② Disconnection of transmission connector (CN2M) on indoor unit ③ Malfunction of sending/receiving circuit on indoor/outdoor unit ④ Disconnection of the connectors on the circuit board</p>
<p>③ The cause of displayed address and attribute is on the indoor unit side An abnormality detected by the remote controller if receiving no ACK when sending data from the remote controller to the indoor unit.</p>	<p>① While operating with multi refrigerant system indoor units, an abnormality is detected when the indoor unit transmit signal to the remote controller during the other refrigerant-system outdoor unit is turned OFF, or within 2 minutes after it turned back ON. ② Contact failure of indoor unit or remote controller transmission line ③ Disconnection of transmission connector (CN2M) on indoor unit ④ Malfunction of sending/receiving circuit on indoor unit or remote controller</p>
<p>④ The cause of the displayed address and attribute is on the remote controller side An abnormality detected by the indoor unit if receiving no ACK when transmitting signal from the indoor unit to the remote controller.</p>	<p>① While operating with multi refrigerant system indoor units, an abnormality is detected when the indoor unit transmit signal to the remote controller during the other refrigerant-system outdoor unit is turned OFF, or within 2 minutes after it turned back ON. ② Contact failure of indoor unit or remote controller transmission line ③ Disconnection of transmission connector (CN2M) on indoor unit ④ Malfunction of sending/receiving circuit on indoor unit or remote controller</p>

Abnormal points and detection methods	Causes and checkpoints
<p>⑤ The cause of displayed address and attribute is on the Fresh Master side An abnormality detected by the indoor unit if receiving no ACK when transmitting signal from the indoor unit to the Fresh Master.</p>	<p>① While the indoor unit is operating with multi refrigerant system Fresh Master, an abnormality is detected when the indoor unit transmits signal to the remote controller while the outdoor unit with the same refrigerant system as the Fresh Master is turned OFF, or within 2 minutes after it turned back ON.</p> <p>② Contact failure of indoor unit or Fresh Master transmission line</p> <p>③ Disconnection of transmission connector (CN2M) on indoor unit or Fresh Master</p> <p>④ Malfunction of sending/receiving circuit on indoor unit or Fresh Master</p>
<p>⑥ The cause of displayed address and attribute is on Lossnay side An abnormality detected by the indoor unit if receiving no ACK when the indoor unit transmit signal to the Lossnay.</p>	<p>① An abnormality is detected when the indoor unit transmits signal to Lossnay while the Lossnay is turned OFF.</p> <p>② While the indoor unit is operating with the other refrigerant Lossnay, an abnormality is detected when the indoor unit transmits signal to the Lossnay while the outdoor unit with the same refrigerant system as the Lossnay is turned OFF, or within 2 minutes after it turned back ON.</p> <p>③ Contact failure of indoor unit or Lossnay transmission line</p> <p>④ Disconnection of transmission connector (CN2M) on indoor unit</p> <p>⑤ Malfunction of sending/receiving circuit on indoor unit or Lossnay</p>
<p>⑦ The controller of displayed address and attribute is not recognized</p>	<p>① The previous address unit does not exist since the address switch was changed while in electric continuity status.</p> <p>② An abnormality detected at transmitting from the indoor unit since the Fresh Master/Lossnay address are changed after synchronized setting of Fresh Master/Lossnay by the remote controller.</p>

●Diagnosis of defects

Make sure to turn the power OFF before connecting/disconnecting any connectors, or replacing boards.

Note:

When the address of the outdoor unit is displayed as abnormal, the outdoor circuit board may be faulty. If the unit is not restored after conducting the following procedure, check the outdoor circuit board.

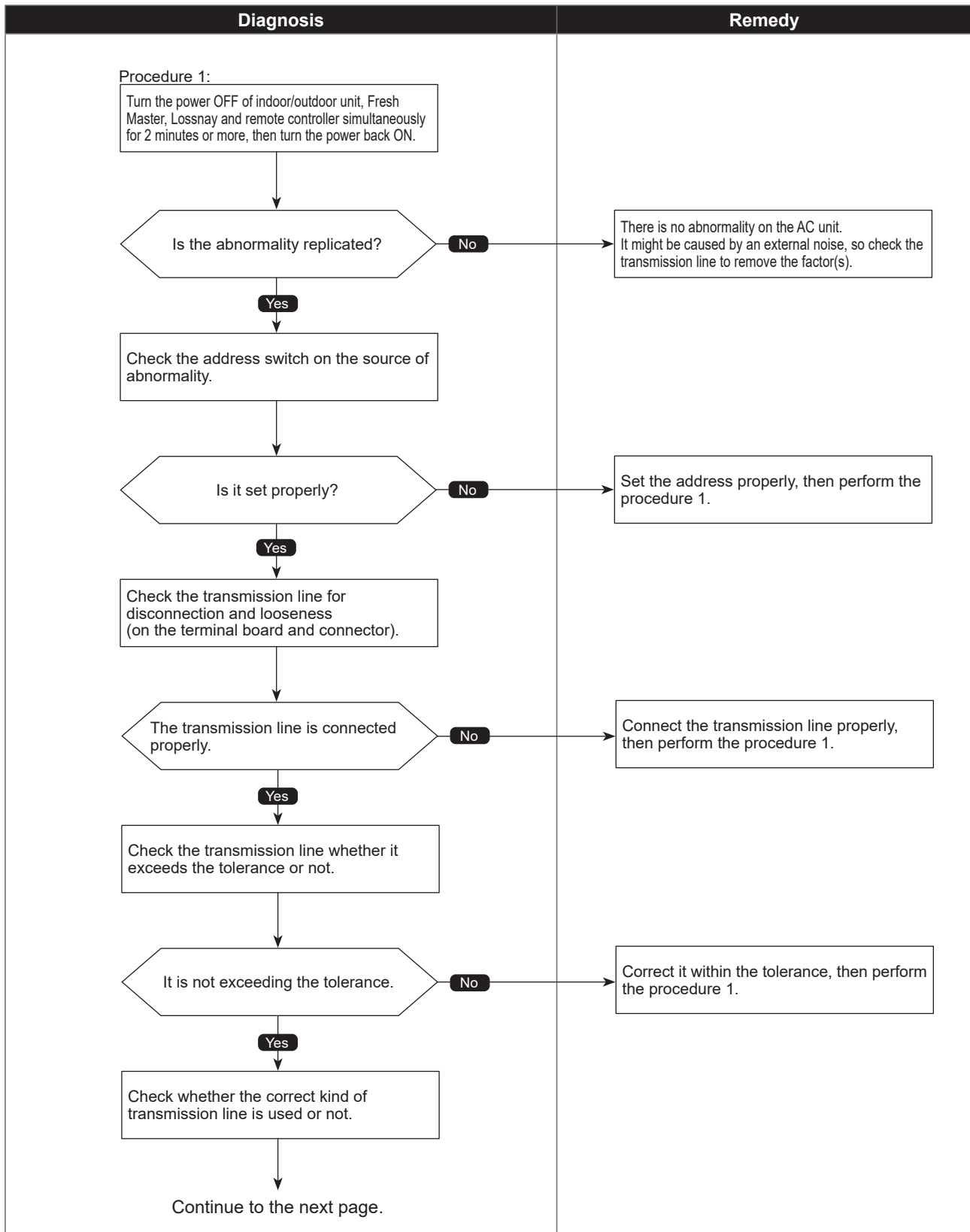

●Diagnosis of defects

Make sure to turn the power OFF before connecting/disconnecting any connectors, or replacing boards.

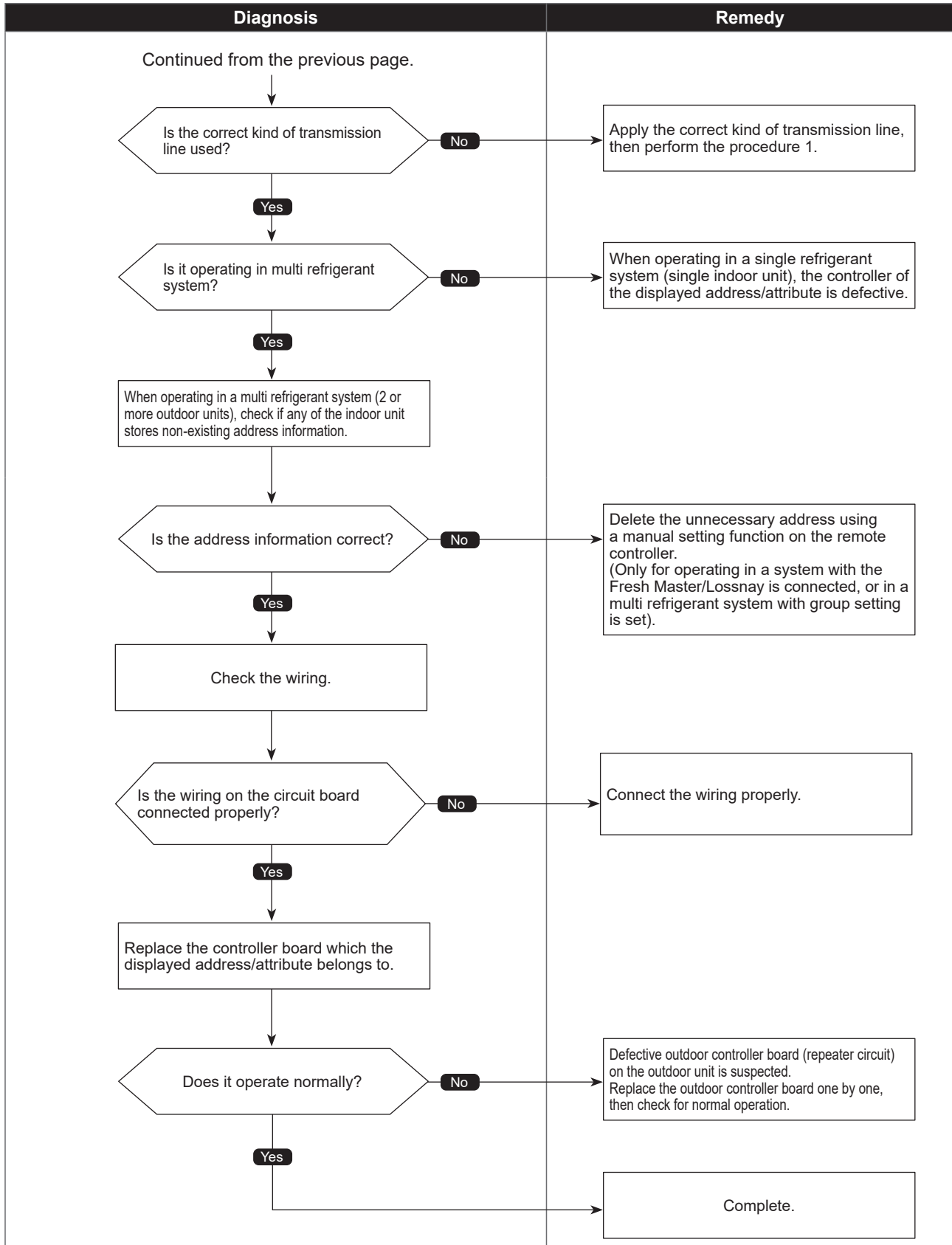

No response frame error

Abnormal points and detection methods	Causes and checkpoints
<p>If receiving no response command while already received ACK. The sending side searches the error in 30 seconds interval for 6 times continuously.</p>	<ul style="list-style-type: none"> ① Continuous failure of transmission due to noise, etc ② Decline of transmission voltage/signal caused by tolerance over on transmission line <ul style="list-style-type: none"> ·At the furthest end: 200 m ·On remote controller line: (12 m) ③ Decline of transmission voltage/signal due to unmatched transmission line types <ul style="list-style-type: none"> ·Types for shield line: CVVS, CPEVS or MVVS ·Line diameter: 1.25 mm² or more ④ Accidental malfunction of error source controller

●Diagnosis of defects

Make sure to turn the power OFF before connecting/disconnecting any connectors, or replacing boards.

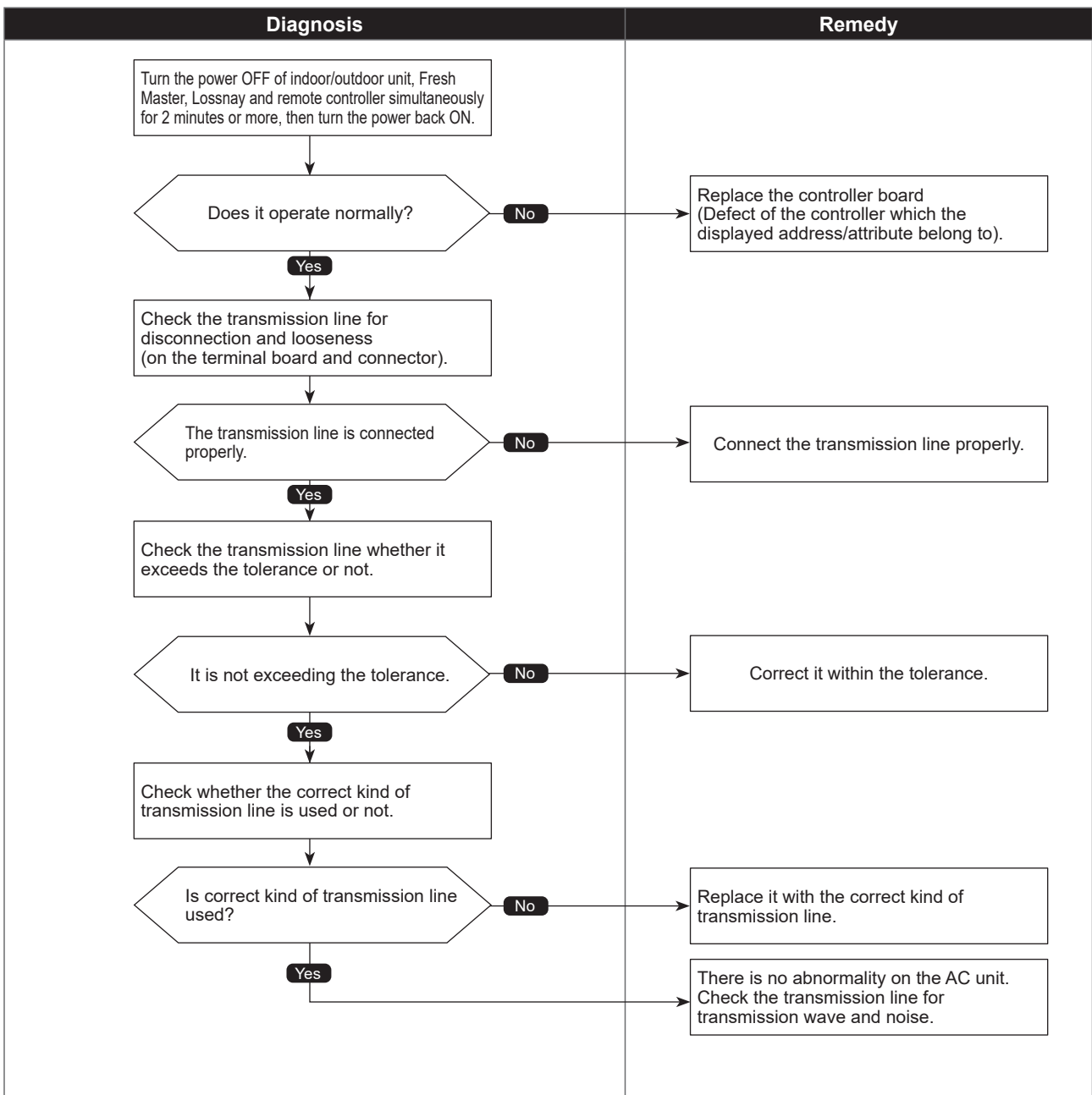

MA communication receive error

Abnormal points and detection methods	Causes and checkpoints
<p>Detected in remote controller or indoor unit:</p> <ul style="list-style-type: none"> ① When the main or sub remote controller cannot receive signal from indoor unit which has the "0" address. ② When the sub remote controller cannot receive signal. ③ When the indoor controller board cannot receive signal from remote controller or another indoor unit. ④ When the indoor controller board cannot receive signal. 	<ul style="list-style-type: none"> ① Contact failure of remote controller wirings ② Irregular Wiring (A wiring length, number of connecting remote controllers or indoor units, or a wiring thickness does not meet the conditions specified in the chapter "Electrical Work" in the indoor unit Installation Manual.) ③ Malfunction of the remote controller sending/receiving circuit on indoor unit with the LED2 is blinking. ④ Malfunction of the remote controller sending/receiving circuit ⑤ Remote controller transmitting error caused by noise interference

●Diagnosis of defects

Make sure to turn the power OFF before connecting/disconnecting any connectors, or replacing boards

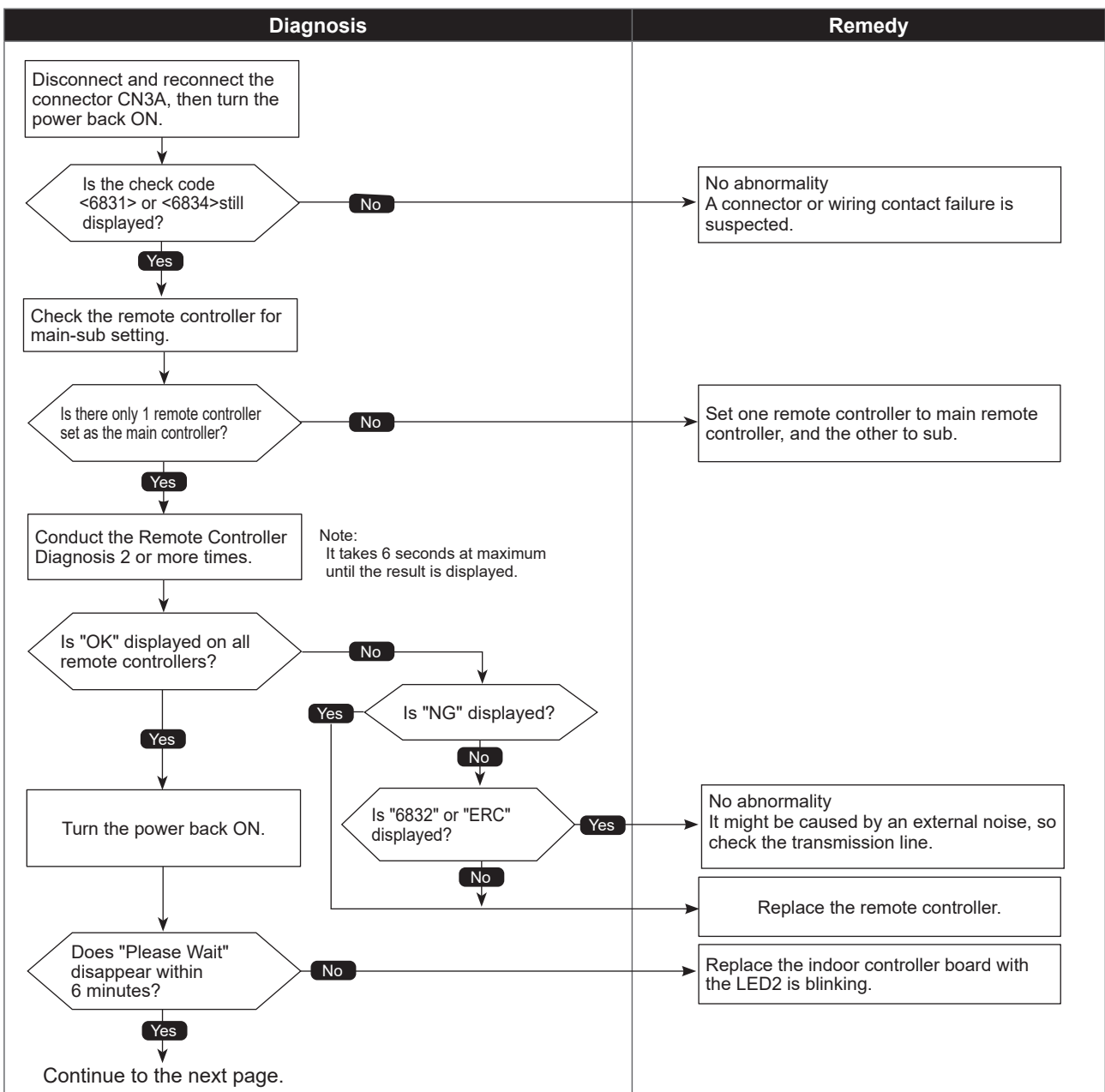

●Diagnosis of defects

Make sure to turn the power OFF before connecting/disconnecting any connectors, or replacing boards

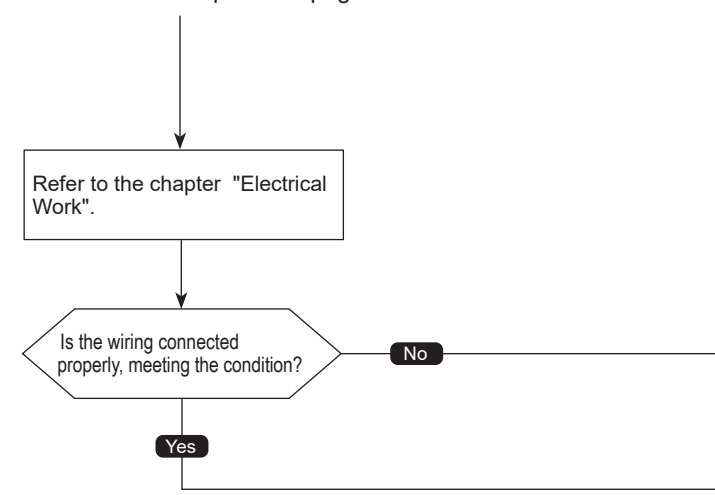
Diagnosis	Remedy
<p>Continued from the previous page.</p>  <pre> graph TD Start[Continued from the previous page.] --> Step1[Refer to the chapter "Electrical Work".] Step1 --> Decision{Is the wiring connected properly, meeting the condition?} Decision -- No --> Remedy1[Connect the wiring properly as specified in the chapter "Electrical Work" in the indoor unit Installation Manual.] Decision -- Yes --> Remedy2[No abnormality. It might be caused by an external noise, so check the transmission line to remove the factor(s).] </pre>	<div data-bbox="970 824 1396 913" style="border: 1px solid black; padding: 5px;"> <p>Connect the wiring properly as specified in the chapter "Electrical Work" in the indoor unit Installation Manual.</p> </div> <div data-bbox="970 958 1396 1070" style="border: 1px solid black; padding: 5px; margin-top: 20px;"> <p>No abnormality It might be caused by an external noise, so check the transmission line to remove the factor(s).</p> </div>

MA communication send error

Abnormal points and detection methods	Causes and checkpoints
Detected in remote controller or indoor unit.	<ul style="list-style-type: none"> ① There are 2 remote controllers set as main. ② Malfunction of remote controller sending/receiving circuit ③ Malfunction of sending/receiving circuit on indoor controller board ④ Remote controller transmitting error caused by noise interference

●Diagnosis of defects

Make sure to turn the power OFF before connecting/disconnecting any connectors, or replacing boards

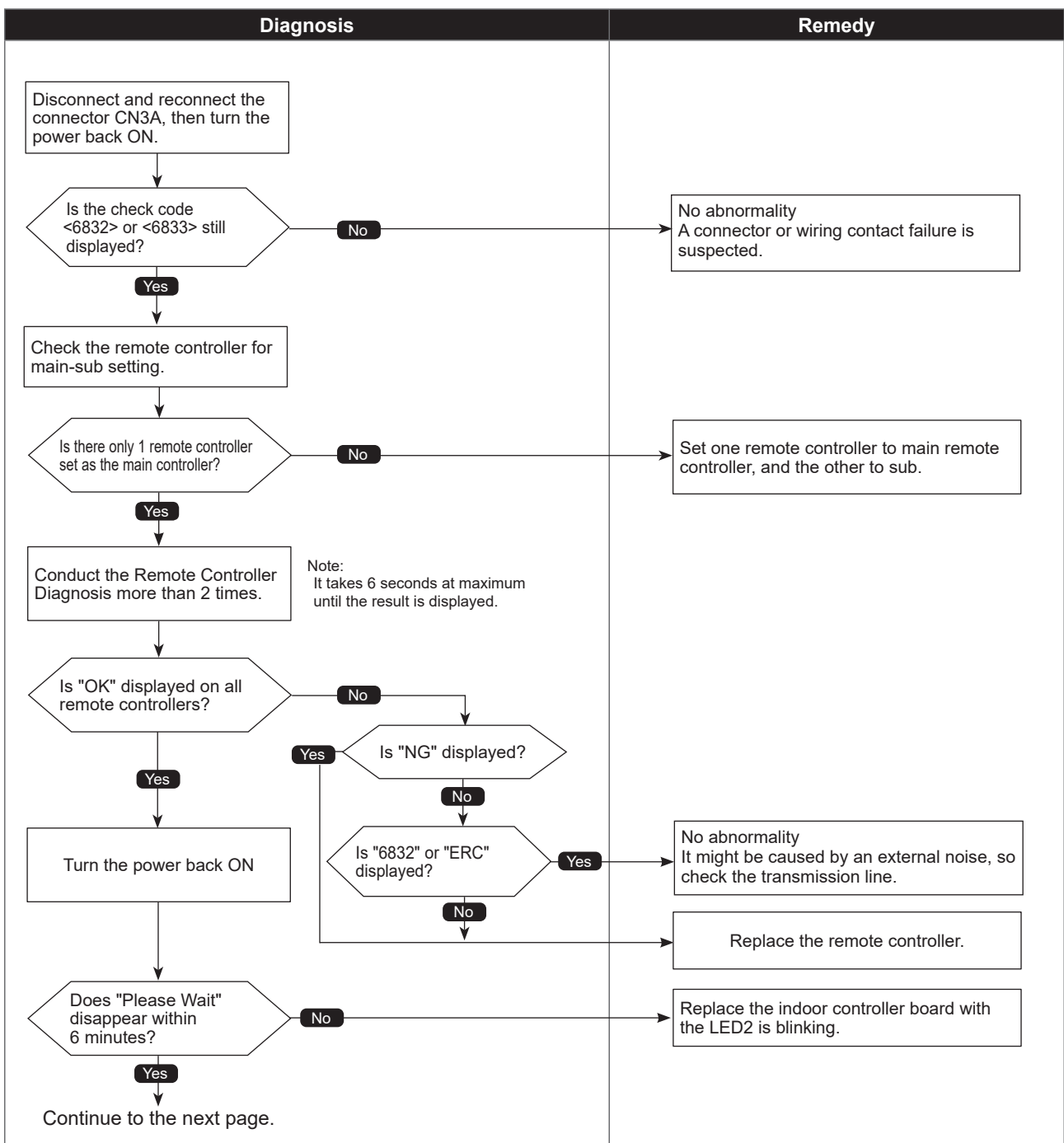

MA communication send error

●Diagnosis of defects

Make sure to turn the power OFF before connecting/disconnecting any connectors, or replacing boards

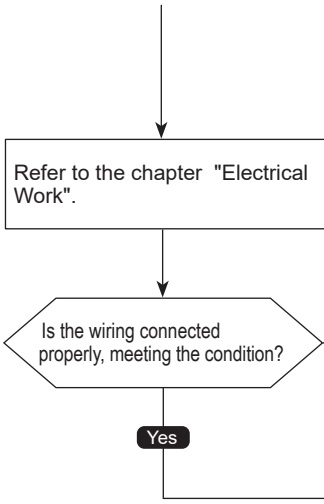
Diagnosis	Remedy
<p>Continued from the previous page.</p>  <pre> graph TD Start[Continued from the previous page.] --> Step1[Refer to the chapter "Electrical Work".] Step1 --> Decision{Is the wiring connected properly, meeting the condition?} Decision -- No --> Remedy1[Connect the wiring properly as specified in the chapter "Electrical Work" in the indoor unit Installation Manual.] Decision -- Yes --> Remedy2[No abnormality. It might be caused by an external noise, so check the transmission line to remove the factor(s).] </pre>	<div data-bbox="963 853 1390 943" style="border: 1px solid black; padding: 5px;"> <p>Connect the wiring properly as specified in the chapter "Electrical Work" in the indoor unit Installation Manual.</p> </div> <div data-bbox="963 987 1390 1111" style="border: 1px solid black; padding: 5px; margin-top: 20px;"> <p>No abnormality It might be caused by an external noise, so check the transmission line to remove the factor(s).</p> </div>

Check code

7100
(EF)

Total capacity error

Abnormal points and detection methods	Causes and checkpoints
When the total capacity of connected indoor units exceeds the specified capacity (130% of the outdoor unit capacity), check code <7100> is displayed.	<ul style="list-style-type: none"> ① The total capacity of connected indoor units exceeds the specified capacity. ② The model name code of the outdoor unit is registered wrongly.

●Diagnosis of defects

Make sure to turn the power OFF before connecting/disconnecting any connectors, or replacing boards.

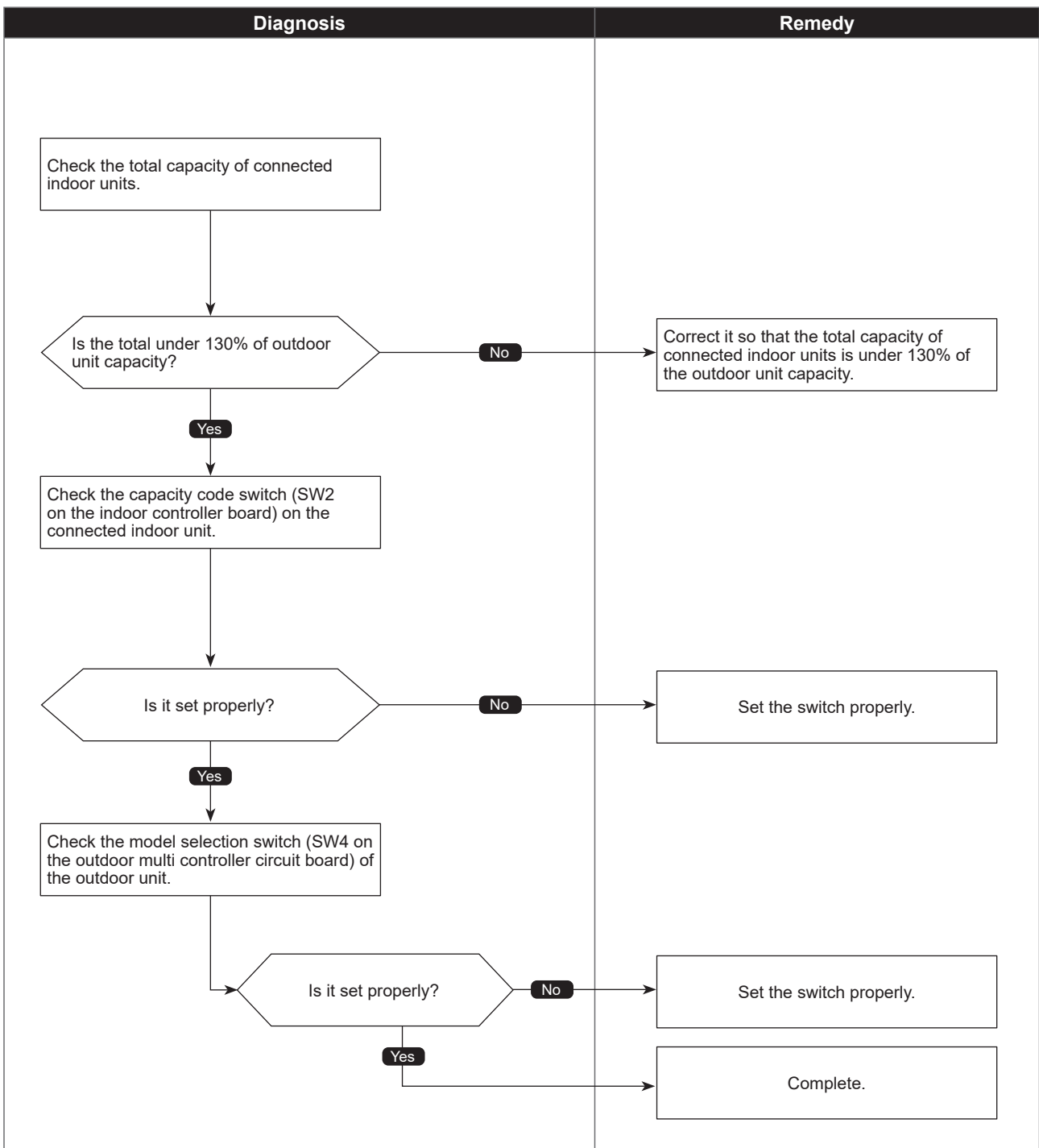

Check code

7101
(EF)

Capacity code error

Abnormal points and detection methods	Causes and checkpoints
When a connected indoor unit is incompatible, check code <7101> is displayed.	The model name of connected indoor unit (model code) is read as incompatible. The connectable indoor units are: · P10 to P250 model (code 2 to 50) · When connecting via branch box : P15 to P50 model (code 4 to 9)

●Diagnosis of defects

Make sure to turn the power OFF before connecting/disconnecting any connectors, or replacing boards.

Diagnosis	Remedy

Check code

7102
(EF)

Connecting unit number error

Abnormal points and detection methods	Causes and checkpoints
When the connected indoor unit exceeds the limit, check code <7102> is displayed.	Connecting more indoor units and branch boxes than the limit. If connecting status does not comply with the following limit; ① Connectable up to 30 indoor units ② Connect at least 1 indoor unit (If connected none). ③ Connectable up to 3 branch boxes

●Diagnosis of defects

Make sure to turn the power OFF before connecting/disconnecting any connectors, or replacing boards.

Diagnosis	Remedy
	<p>Connect less number of units than the limit.</p> <p>* The model code of the connected indoor unit can be displayed by an operation of SW1 on the outdoor unit.</p> <p>Connect indoor unit.</p> <p>Check whether the M-NET line to the indoor unit is connected or not.</p>

Address setting error

Abnormal points and detection methods	Causes and checkpoints
The address setting of connected unit is wrong.	There is a unit without correct address setting in the range specified in "7-3. SYSTEM CONTROL".

●Diagnosis of defects

Make sure to turn the power OFF before connecting/disconnecting any connectors, or replacing boards.

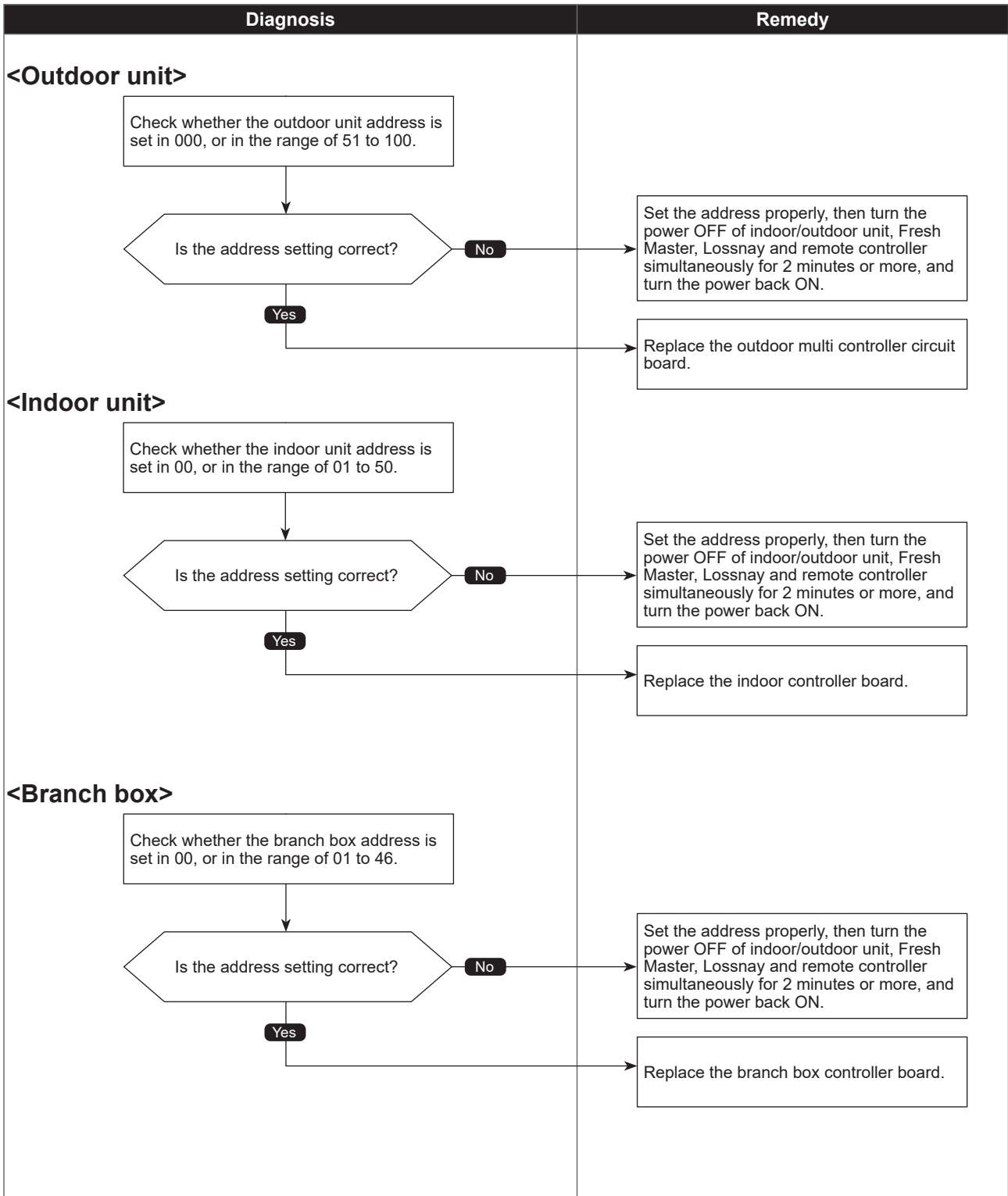

●Diagnosis of defects

Make sure to turn the power OFF before connecting/disconnecting any connectors, or replacing boards.

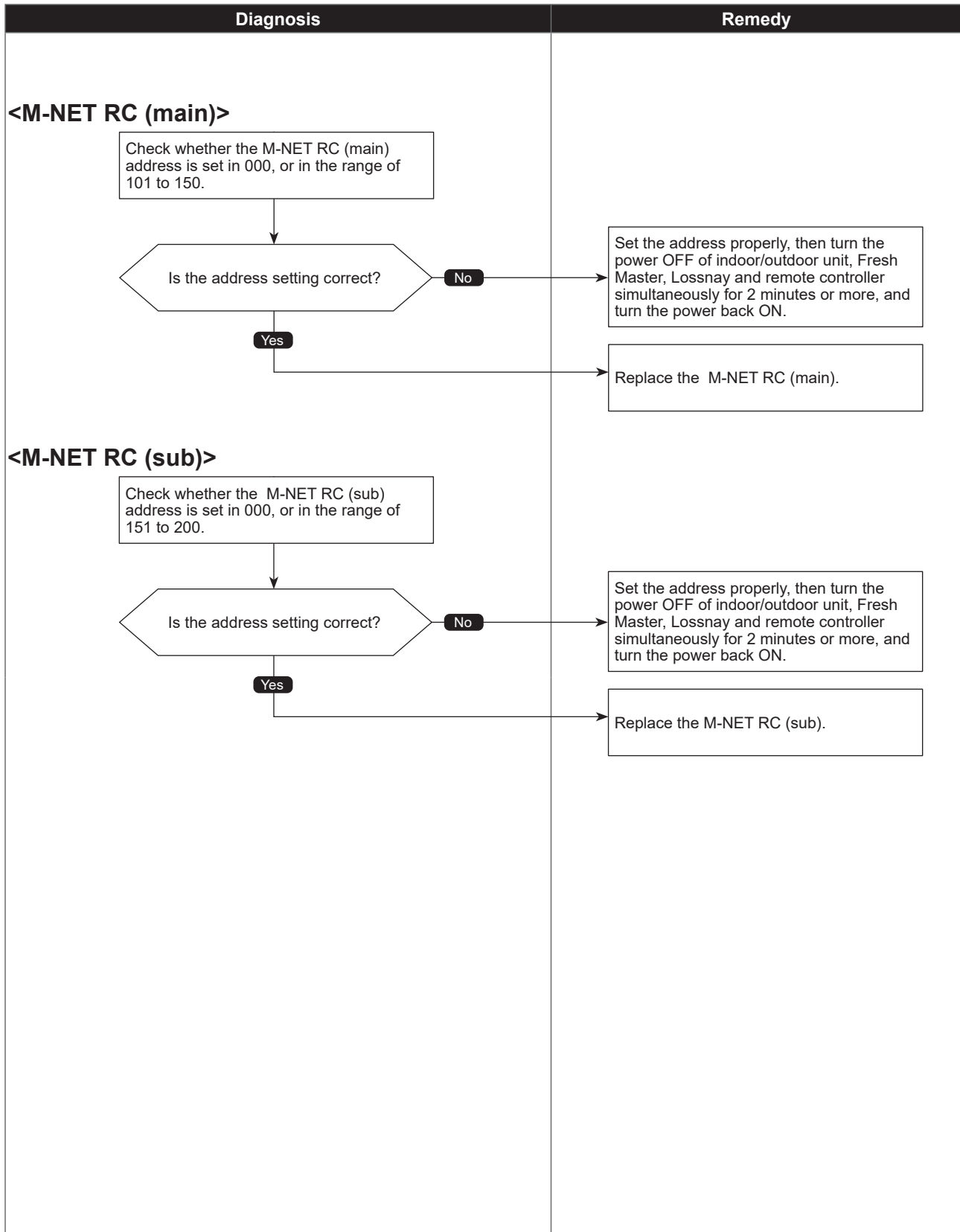

Check code

7130
(EF)

Incompatible unit combination error

Abnormal points and detection methods

When the connected indoor unit is not compatible with the outdoor unit, the outdoor unit detects the error at startup.

Causes and checkpoints

Connecting indoor unit (s) which is not authorized to connect to the outdoor unit.

●Diagnosis of defects

Make sure to turn the power OFF before connecting/disconnecting any connectors, or replacing boards.

Diagnosis

Remedy

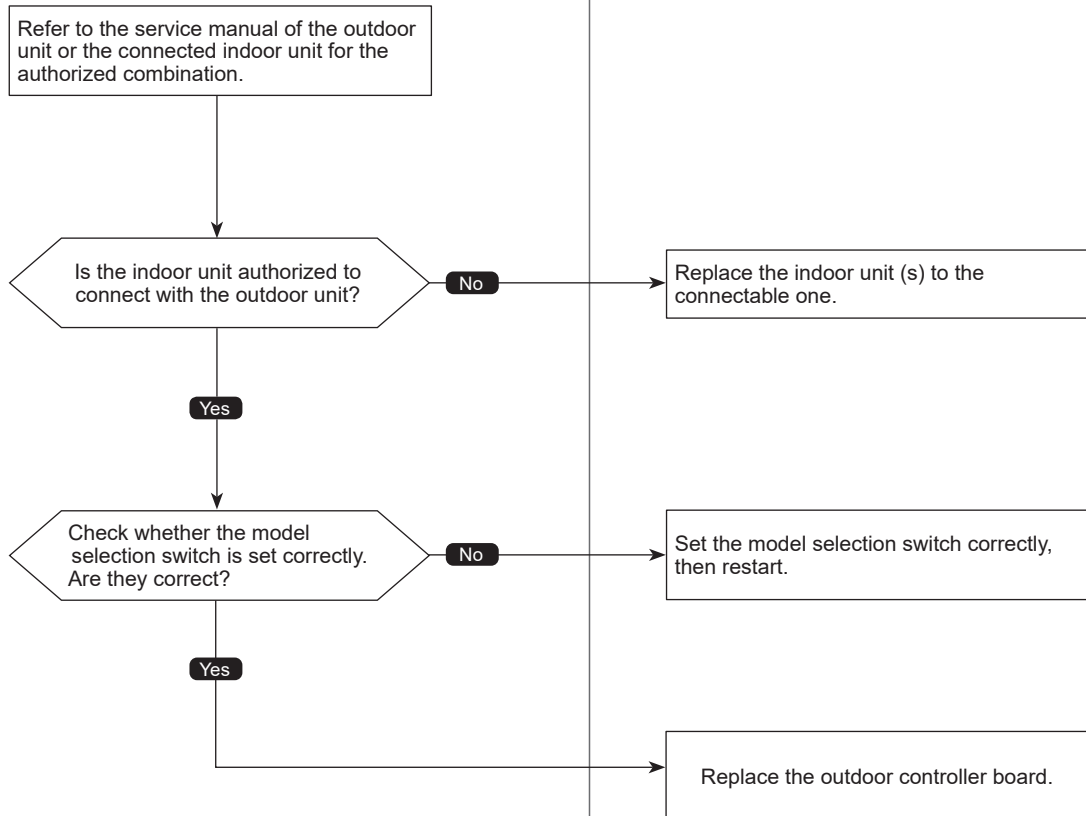

8-2. REMOTE CONTROLLER DIAGNOSIS

Refer to 12-8. "REMOTE CONTROLLER CHECK" for MA remote controller system.











8-3. THE FOLLOWING SYMPTOM DO NOT REPRESENT TROUBLE (EMERGENCY)

Symptom	Display of remote controller	Cause
Even the cooling (heating) operation selection button is pressed, the indoor unit cannot be operated.	"Cooling (Heating)" blinks	The indoor unit cannot cool (Heat) if other indoor units are heating (Cooling).
The auto vane runs freely.	Normal display	Because of the control operation of auto vane, it may change over to horizontal blow automatically from the downward blow in cooling because the downward blow operation has been continued for 1 hour. At defrosting in heating, hot adjusting and thermostat OFF, it automatically changes over to horizontal blow.
Fan setting changes during heating.	Normal display	Ultra-low speed operation is commenced at thermostat OFF. Light air automatically change over to set value by time or piping temperature at thermostat ON.
Fan stops during heating operation.	"Heat Defrost ●●"	The fan stops during defrosting.
Fan does not stop while operation has been stopped.	Light out	Fan runs for 1 minute after stopping to exhaust residual heat (only in heating).
No setting of fan while start SW has been turned on.	"Heat Standby ●●"	Ultra-low speed operation for 5 minutes after SW ON or until piping temperature reaches 35°C. Then low speed operates for 2 minutes and operates at the normal set air volume. (Hot adjust control)
Indoor unit remote controller shows "Please Wait" indicator for about 2 minutes when turning ON power supply.	"Please Wait" blinks	The system is in the process of startup. Operate remote controller again after "Please Wait" disappears.
Drain pump does not stop while unit has been stopped.	Light out	After a stop of cooling operation, unit continues to operate drain pump for 3 minutes and then stops.
Drain pump continues to operate while unit has been stopped.	—	Unit continues to operate drain pump if drainage is generated, even during a stop.

8-4. INTERNAL SWITCH FUNCTION TABLE

PUMY-P250YBM2 PUMY-P300YBM2

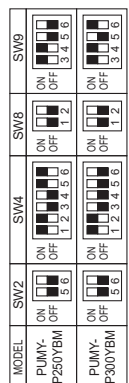
The black square (■) indicates a switch position.

Switch	Step	Function	Operation in Each Switch Setting		Remarks	Purpose	Additional Information
			ON	OFF			
SWU1 ones digit SWU2 tens digit	Rotary switch		Before turning the power ON		<Initial settings> 	—	—
	Digital Display Switch		Can be set either during operation or not.		<Initial settings> 	—	—
SW1	1-8		Without centralized controller		<Initial settings> 	Turn ON when the centralized controller is connected to the outdoor unit.	• SW2-1 must be turned ON if a central controller is connected to the system. An example of this would be a TC-24, EB50A, AG160, AE50 or AE200. If SW2-1 is not turned on, while using a central controller, in rare circumstances problems may be encountered such as indoor units not responding to group commands. Therefore, turning SW2-1 ON is recommended if a central controller is used. • Group setting of 2 or more A-I-C units which is connected to branch box via centralized controller is not allowed.
	1	Selects operating system startup	With centralized controller	Without centralized controller			
	2	Connection Information Clear Switch	Clear	Do not clear			When relocating units or connecting additional units.
SW2 Function Switch	3	Abnormal data clear switch input	Clear abnormal data	Normal	<Initial settings> 	To delete an error history.	—
	4	Pump down	ON	OFF		To facilitate outdoor unit the pumping down operation. Frequency = Fixed to 65 Hz Indoor linear expansion valve = Fully open Outdoor fan step = Fixed to 14	Please refer to a section referring to the pumping down on outdoor units Installation Manuals. It might not be possible to collect all the refrigerant if the amount is excessive. Do not perform pump down work when there is a gas leak. The intake of air or other gases causes abnormally high pressure in the refrigeration cycle, which may cause explosion or injury.
SW3 Trial operation	5	—	—	—		—	—
	6	—	—	—		—	—
SW2/ SW4/ SW8/ SW9 Model Switch	1	ON/OFF from outdoor unit	ON	OFF	<Initial settings> 	—	—
	2	Mode setting	Heating	Cooling		—	—
SW5 Function switch	MODEL SELECTION						
	1-6		Before the power is turned ON.		<Initial settings> Set for each capacity.	—	—
	1	—	—	—	<Initial settings> 	To set the LEV opening at startup higher than usual. (+ 150 pulses) To improve the operation with the LEV almost clogged.	The refrigerant flow noise at startup become louder.
	2	Change the indoor unit's LEV opening at startup	Enable	Normal			
	3	—	—	—			
4	—	—	—				
5	Change the indoor unit's LEV opening at defrost	Enable	Normal			To set the LEV opening higher than usual during defrosting operation. (Only Oj ≤ 10 is valid. + 300 pulses) To avoid the discharge temperature increase and provide efficient defrosting operation.	The refrigerant flow noise during the defrosting operation become louder.

The black square (■) indicates a switch position.

Switch	Step	Function	Operation in Each Switch Setting		Remarks	Purpose	Additional Information
			ON	OFF			
SW5 function switch	6	Switching the target sub cool (Heating mode)	Enable	Normal	<Initial settings> ON <input type="checkbox"/> <input type="checkbox"/> <input type="checkbox"/> <input type="checkbox"/> <input type="checkbox"/> <input type="checkbox"/> <input type="checkbox"/> <input type="checkbox"/> <input type="checkbox"/> <input type="checkbox"/> OFF <input type="checkbox"/> <input type="checkbox"/> <input type="checkbox"/> <input type="checkbox"/> <input type="checkbox"/> <input type="checkbox"/> <input type="checkbox"/> <input type="checkbox"/> <input type="checkbox"/> <input type="checkbox"/>	To decrease the target sub cool value. To reduce the discharge temperature decrease due to refrigerant liquid accumulation in the units.	A refrigerant flow noise might be generated if the sub cool value is too small.
	7	While the outdoor unit is in HEAT operation, additionally increase about 50 to 70 pulses of the LEV opening on the indoor unit which is in FAN, STOP, COOL or thermo-OFF.*1	Active	Inactive	Can be set when OFF or during operation	To additionally increase about 50 to 70 pulses of the LEV opening for units other than in HEAT operation. To avoid a refrigerant shortage (less capacity) due to refrigerant liquid accumulation in the units which is not in operation.	A refrigerant flow noise might be generated in units other than the one in operation.
	8	While the outdoor unit is in HEAT operation, fully close the linear expansion valve on the indoor unit which is in FAN or COOL.*2	Enable	Normal		To reduce the room temperature increase by setting the LEV opening lower for the indoor units in FAN or COOL.	The refrigerant is more likely to collect in the indoor units in FAN or COOL, which can cause refrigerant shortage of units. (Results in less capacity and increase of discharge temperature.)
SW6 function switch	1		—	—	<Initial settings> ON <input type="checkbox"/> <input type="checkbox"/> <input type="checkbox"/> <input type="checkbox"/> <input type="checkbox"/> <input type="checkbox"/> <input type="checkbox"/> <input type="checkbox"/> <input type="checkbox"/> <input type="checkbox"/> OFF <input type="checkbox"/> <input type="checkbox"/> <input type="checkbox"/> <input type="checkbox"/> <input type="checkbox"/> <input type="checkbox"/> <input type="checkbox"/> <input type="checkbox"/> <input type="checkbox"/> <input type="checkbox"/>	This switch is used to lower the primary current limit -3.0 A.	The performance of the unit might be somewhat reduced since the frequency would not rise enough due to the lowered current limitation.
	2	Switching the primary current limitation	Enable	Normal	Before turning the power ON.		
	3		—	—			
	4	Change of defrosting control	Enable (For high humidity)	Normal		To shorten the defrosting prohibition time in high humidity (or heavy snow) region, in order to reduce malfunctions caused by frost.	The performance of the HEAT operation is somewhat reduced since the defrosting operation is frequently performed.
	5	External static pressure mode	Enable	Normal	Can be set when OFF or during operation	To raise the fan rotation to raise the performance when an external static pressure is applied. It can support the external static pressure up to 30 Pa. The power input and the sound level become larger due to increasing the outdoor unit's fan rotation.	
	6	Switching the target discharge pressure (Pdm)	Enable	Normal		To raise the performance by setting the Pdm higher during HEAT operation. Power consumption is raised due to a higher frequency. (The performance would not be raised at the maximum operating frequency.)	
SW7 function switch	7	Switching (1) the target evaporation temperature (ETm)	Enable	Normal	SW6-7 ON <input type="checkbox"/> <input type="checkbox"/> <input type="checkbox"/> <input type="checkbox"/> <input type="checkbox"/> <input type="checkbox"/> <input type="checkbox"/> <input type="checkbox"/> <input type="checkbox"/> <input type="checkbox"/> OFF <input type="checkbox"/> <input type="checkbox"/> <input type="checkbox"/> <input type="checkbox"/> <input type="checkbox"/> <input type="checkbox"/> <input type="checkbox"/> <input type="checkbox"/> <input type="checkbox"/> <input type="checkbox"/>	To raise/reduce the performance by changing the target ETm during COOL operation.	Switching it to raise the performance, it raises the power consumption, and produces more dew condensation.
	8	Switching (2) the target evaporation temperature (ETm)	Enable	Normal	Target ETm (°C) 9 11 6 14	Switch to raise the performance: raises the performance Switch to reduce the performance: prevents dew condensation	Switching it to reduce the performance, it makes the performance insufficient.
	1	Ignore current sensor abnormality and rotational frequency abnormality of outdoor fan motor	Enable	Normal	After turning the power ON.	To perform a test run for electrical parts alone without running the compressor. Also, to perform the troubleshooting of electrical parts without operating the outdoor unit's fan.	Make sure to connect the connectors to the compressor after checking the electrical parts. Be careful not to get electrical shock while working on electrical parts.
	2		—	—			
	3		—	—			
	4	Maximum frequency down at 1 hour after COOL operation	Enable	Normal	Can be set when OFF or during operation.	To reduce dew condensation on the indoor unit by lowering the frequency.	The performance might be insufficient.
SW9 Function Switch	5	Manual defrost	Manual defrost	Normal			
	6	Auto change over from remote controller (IC with the minimum address)	Enable	Disable	Before turning the power ON	Turn ON when it is necessary to perform the defrosting operation forcibly. (Effective only at startup, or 10 minutes after the last defrosting operation)	It performs the defrosting operation forcibly. (HEAT operation is stopped temporarily)
	1	Switching the Silent/Demand mode	Demand control	Silent mode	Can be set when OFF or during operation	Enables the indoor unit with the minimum address to select AUTO mode, and switches the operation mode of the other indoor units to the same mode.	Cannot be set when the centralized control is ON.
	2		—	—	<Initial settings> ON <input type="checkbox"/> <input type="checkbox"/> <input type="checkbox"/> <input type="checkbox"/> <input type="checkbox"/> <input type="checkbox"/> <input type="checkbox"/> <input type="checkbox"/> <input type="checkbox"/> <input type="checkbox"/> OFF <input type="checkbox"/> <input type="checkbox"/> <input type="checkbox"/> <input type="checkbox"/> <input type="checkbox"/> <input type="checkbox"/> <input type="checkbox"/> <input type="checkbox"/> <input type="checkbox"/> <input type="checkbox"/>		About the Silent mode/Demand control setting, refer to "8-5. OUTDOOR UNIT INPUT/OUTPUT CONNECTOR".
	3		—	—			
	4		—	—			

*1 SW5-7 Opens the indoor linear expansion valve as a countermeasure against the indoor unit in FAN, COOL, STOP, or thermo-OFF operation with refrigerant-shortage status due to an accumulation of liquid refrigerant.
*2 SW5-8 Countermeasure against room temperature rise for indoor unit in FAN and COOL mode.

8-5. OUTDOOR UNIT INPUT/OUTPUT CONNECTOR

• State (CN51)

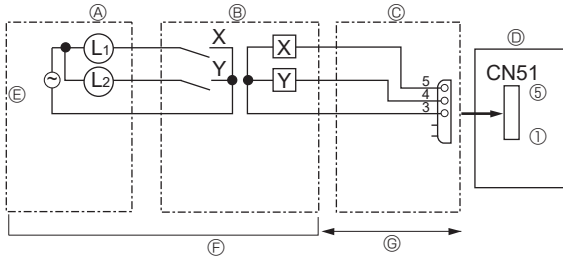

- Ⓐ Distant control board
- Ⓑ Relay circuit
- Ⓒ External output adapter (PAC-SA88HA-E)
- Ⓓ Outdoor unit control board
- Ⓔ Lamp power supply
- Ⓕ Procure locally
- Ⓖ Maximum 10 m

L1: Error display lamp
 L2: Compressor operation lamp
 X, Y: Relay (coil rating: ≤ 0.9 W, 12 VDC)

• Auto change over (CN3N)

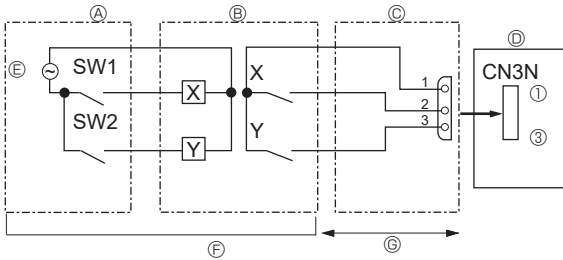

- Ⓐ Remote control panel
- Ⓑ Relay circuit
- Ⓒ External input adapter (PAC-SC36NA-E)
- Ⓓ Outdoor unit control board
- Ⓔ Relay power supply
- Ⓕ Procure locally
- Ⓖ Maximum 10 m

SW1: Switch
 SW2: Switch
 X, Y: Relay (contact rating: ≥ 0.1 A, 15 VDC)
 (min. applicable load: ≤ 1 mA)

	ON	OFF
SW1	Heating	Cooling
SW2	Validity of SW1	Invalidity of SW1

• Silent Mode/Demand Control (CN3D)

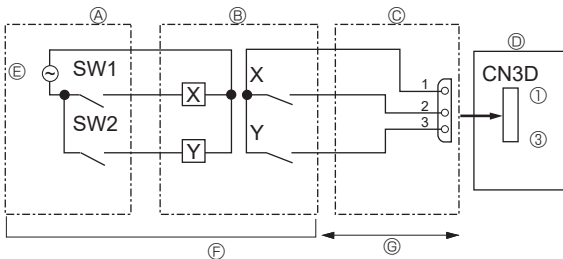

- Ⓐ Remote control panel
- Ⓑ Relay circuit
- Ⓒ External input adapter (PAC-SC36NA-E)
- Ⓓ Outdoor unit control board
- Ⓔ Relay power supply
- Ⓕ Procure locally
- Ⓖ Maximum 10 m

SW1: Switch
 SW2: Switch
 X, Y: Relay (contact rating: ≥ 0.1 A, 15 VDC)
 (min. applicable load: ≤ 1 mA)

The silent mode and the demand control are selected by switching the DIP switch 9-2 on outdoor controller board. It is possible to set it to the following power consumption (compared with ratings) by setting SW1, 2.

	Outdoor controller board DIP SW9-2	SW1	SW2	Function	
				Cooling	Heating
Silent mode	OFF	OFF	OFF	Normal	Normal
		ON	OFF	Silent mode	Silent mode
		OFF	ON	Super silent mode 1	Silent mode
		ON	ON	Super silent mode 2	Silent mode
Demand control	ON	OFF	OFF	100% (Normal)	
		ON	OFF	75%	
		ON	ON	50%	
		OFF	ON	0% (Stop)	

8-6. HOW TO CHECK THE PARTS

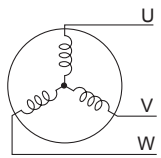
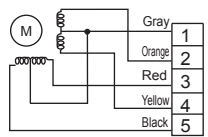
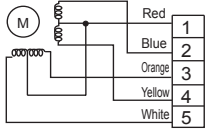
Parts name	Checkpoints														
Thermistor (TH2) <HIC Pipe> Thermistor (TH3) <Outdoor Liquid Pipe> Thermistor (TH4) <Compressor> Thermistor (TH6) <Suction Pipe> Thermistor (TH7) <Ambient> Thermistor (TH8) <Heat Sink>	Disconnect the connector then measure the resistance with a multimeter. (At the ambient temperature 10 to 30°C) <table border="1" style="margin-top: 10px;"> <thead> <tr> <th></th> <th>Normal</th> <th>Abnormal</th> </tr> </thead> <tbody> <tr> <td>TH4</td> <td>160 to 410 kΩ</td> <td rowspan="5">Open or short</td> </tr> <tr> <td>TH2</td> <td rowspan="3">4.3 to 9.6 kΩ</td> </tr> <tr> <td>TH3</td> </tr> <tr> <td>TH6</td> </tr> <tr> <td>TH7</td> </tr> <tr> <td>TH8</td> <td>39 to 105 kΩ</td> </tr> </tbody> </table>		Normal	Abnormal	TH4	160 to 410 kΩ	Open or short	TH2	4.3 to 9.6 kΩ	TH3	TH6	TH7	TH8	39 to 105 kΩ	
	Normal	Abnormal													
TH4	160 to 410 kΩ	Open or short													
TH2	4.3 to 9.6 kΩ														
TH3															
TH6															
TH7															
TH8	39 to 105 kΩ														
Fan motor (MF1, MF2)	Refer to the next page.														
Solenoid valve coil <4-way valve> (21S4)	Measure the resistance between the terminals with a multimeter. (At the ambient temperature 20°C) <table border="1" style="margin-top: 10px;"> <thead> <tr> <th>Normal</th> <th>Abnormal</th> </tr> </thead> <tbody> <tr> <td>2085 ± 208.5 Ω</td> <td>Open or short</td> </tr> </tbody> </table>	Normal	Abnormal	2085 ± 208.5 Ω	Open or short										
Normal	Abnormal														
2085 ± 208.5 Ω	Open or short														
Motor for compressor (MC) 	Measure the resistance between the terminals with a multimeter. (Winding temperature 20°C) <table border="1" style="margin-top: 10px;"> <thead> <tr> <th>Normal</th> <th>Abnormal</th> </tr> </thead> <tbody> <tr> <td>0.265 ± 0.013 Ω</td> <td>Open or short</td> </tr> </tbody> </table>	Normal	Abnormal	0.265 ± 0.013 Ω	Open or short										
Normal	Abnormal														
0.265 ± 0.013 Ω	Open or short														
Solenoid valve coil <Bypass valve> (SV1) <Oil return valve> (SV3)	Measure the resistance between the terminals with a multimeter. (At the ambient temperature 20°C) <table border="1" style="margin-top: 10px;"> <thead> <tr> <th>Normal</th> <th>Abnormal</th> </tr> </thead> <tbody> <tr> <td>1182.5 ± 83 Ω</td> <td>Open or short</td> </tr> </tbody> </table>	Normal	Abnormal	1182.5 ± 83 Ω	Open or short										
Normal	Abnormal														
1182.5 ± 83 Ω	Open or short														
Linear expansion Valve (LEV-A) 	<table border="1" style="margin-top: 10px;"> <thead> <tr> <th colspan="4">Normal</th> <th>Abnormal</th> </tr> </thead> <tbody> <tr> <td>Gray - Black</td> <td>Gray - Red</td> <td>Gray - Yellow</td> <td>Gray - Orange</td> <td rowspan="2">Open or short</td> </tr> <tr> <td colspan="4" style="text-align: center;">46 ± 3 Ω</td> </tr> </tbody> </table>	Normal				Abnormal	Gray - Black	Gray - Red	Gray - Yellow	Gray - Orange	Open or short	46 ± 3 Ω			
Normal				Abnormal											
Gray - Black	Gray - Red	Gray - Yellow	Gray - Orange	Open or short											
46 ± 3 Ω															
Linear expansion Valve (LEV-B) 	<table border="1" style="margin-top: 10px;"> <thead> <tr> <th colspan="4">Normal</th> <th>Abnormal</th> </tr> </thead> <tbody> <tr> <td>Red - White</td> <td>Red - Orange</td> <td>Red - Yellow</td> <td>Red - Blue</td> <td rowspan="2">Open or short</td> </tr> <tr> <td colspan="4" style="text-align: center;">46 ± 4 Ω</td> </tr> </tbody> </table>	Normal				Abnormal	Red - White	Red - Orange	Red - Yellow	Red - Blue	Open or short	46 ± 4 Ω			
Normal				Abnormal											
Red - White	Red - Orange	Red - Yellow	Red - Blue	Open or short											
46 ± 4 Ω															

Check method of DC fan motor (fan motor/outdoor multi controller circuit board)

1. Notes:

- High voltage is applied to the connector (CNF1, 2) for the fan motor. Pay attention to the service.
- Do not pull out the connector (CNF1, 2) for the motor with the power supply on.
(It causes trouble of the outdoor multi controller circuit board and fan motor.)

2. Self check

Symptom: The outdoor fan cannot rotate.

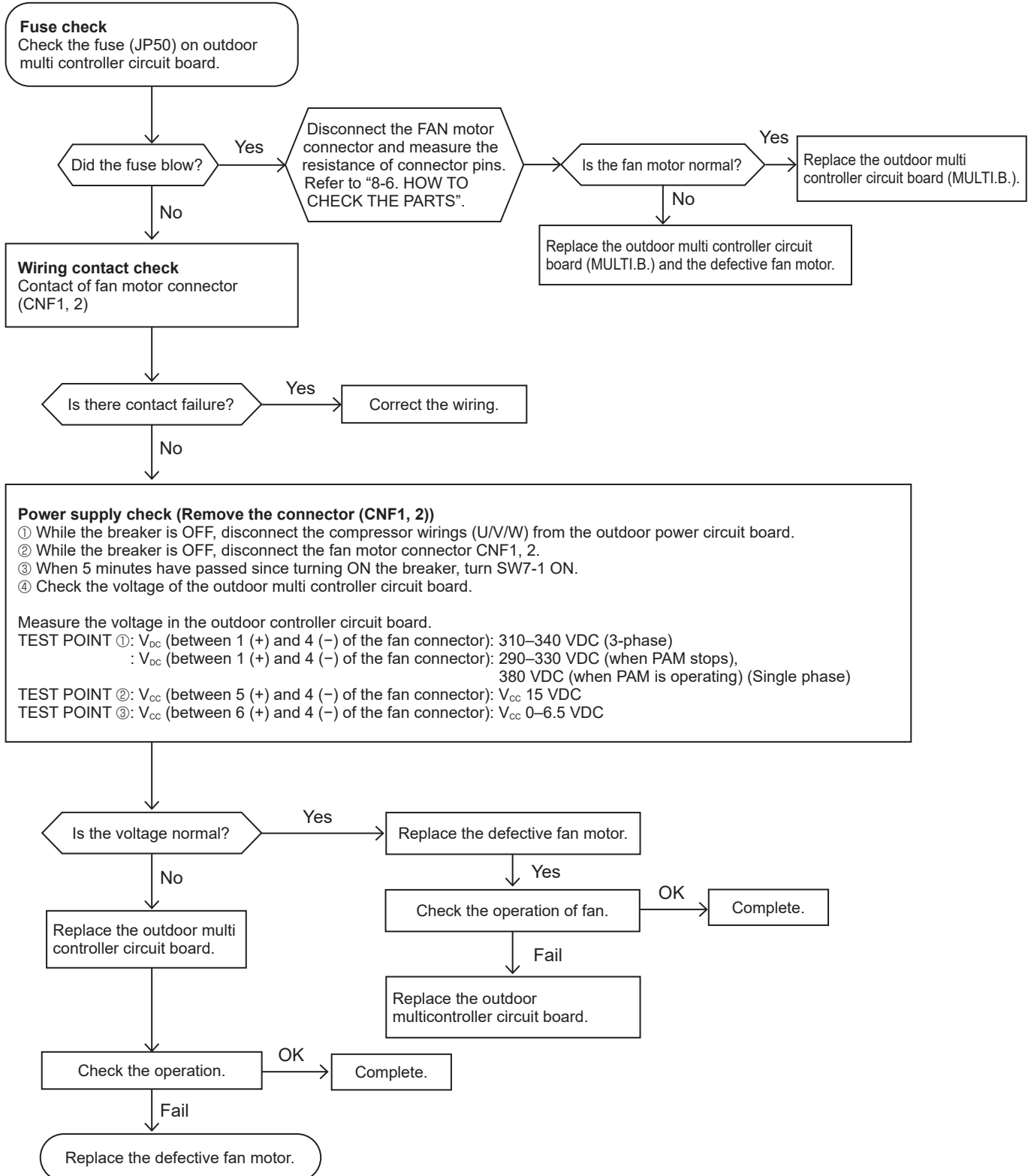

Note: Turn SW7-1 OFF after the troubleshooting completes.

The fan sometimes starts on-off cycle operation during low-load operation or cooling at low ambient temperature. It is not abnormal; the operation ensures reliability of the product.

8-7. HOW TO CHECK THE COMPONENTS

<Thermistor feature chart>

Low temperature thermistors

- Thermistor <HIC Pipe> (TH2)
- Thermistor <Outdoor Liquid Pipe> (TH3)
- Thermistor <Suction Pipe> (TH6)
- Thermistor <Ambient> (TH7)

Thermistor R0 = 15 kΩ ± 3 %
B constant = 3480 ± 1 %

$$R_t = 15 \exp\left\{3480\left(\frac{1}{273+t} - \frac{1}{273}\right)\right\}$$

0°C	15 kΩ	30°C	4.3 kΩ
10°C	9.6 kΩ	40°C	3.0 kΩ
20°C	6.3 kΩ		
25°C	5.2 kΩ		

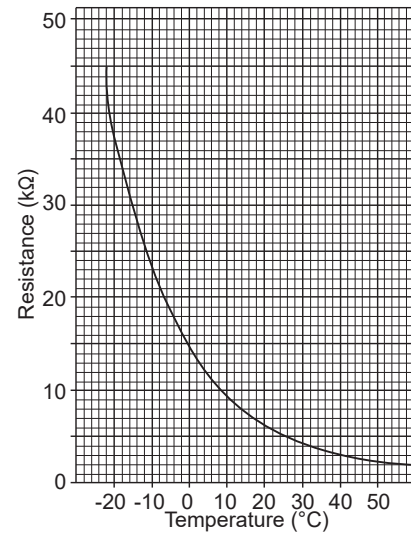

Medium temperature thermistor

- Thermistor <Heat Sink> (TH8)

Thermistor R50 = 17 kΩ ± 2 %
B constant = 4150 ± 3 %

$$R_t = 17 \exp\left\{4150\left(\frac{1}{273+t} - \frac{1}{323}\right)\right\}$$

0°C	180 kΩ
25°C	50 kΩ
50°C	17 kΩ
70°C	8 kΩ
90°C	4 kΩ

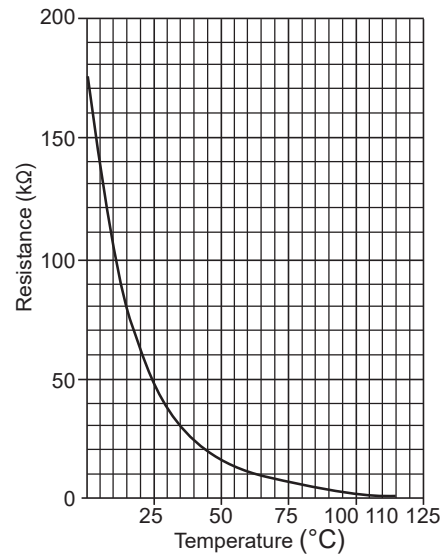

High temperature thermistor

- Thermistor <Compressor> (TH4)

Thermistor R120 = 7.465 kΩ ± 2 %
B constant = 4057 ± 2 %

$$R_t = 7.465 \exp\left\{4057\left(\frac{1}{273+t} - \frac{1}{393}\right)\right\}$$

20°C	250 kΩ	70°C	34 kΩ
30°C	160 kΩ	80°C	24 kΩ
40°C	104 kΩ	90°C	17.5 kΩ
50°C	70 kΩ	100°C	13.0 kΩ
60°C	48 kΩ	110°C	9.8 kΩ

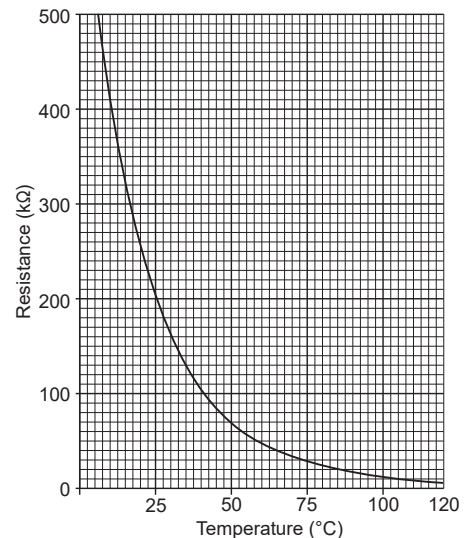

<HIGH PRESSURE SENSOR>

• Comparing the High Pressure Sensor Measurement and Gauge Pressure

By configuring the digital display setting switch (SW1) as shown in the figure below, the pressure as measured by the high pressure sensor appears on the LED1 on the control board.



The figure at left shows that the switches 1 through 4 are set to ON and 5 through 8 are set to OFF.

(1) While the outdoor unit is stopped, compare the gauge pressure and the pressure displayed on self-diagnosis LED1, 2.

- 1) When the gauge pressure is between 0 and 0.098 MPaG [14 PSIG], internal pressure is caused due to gas leak.
- 2) When the pressure displayed on self-diagnosis LED1, 2 is between 0 and 0.098 MPaG [14 PSIG], the connector may be defective or be disconnected. Check the connector and go to (4).
- 3) When the pressure displayed on self-diagnosis LED1, 2 exceeds 5.0 MPaG [725 PSIG], go to (3).
- 4) If other than 1), 2) or 3), compare the pressures while the sensor is running. Go to (2).

(2) Compare the gauge pressure and the pressure displayed on self-diagnosis LED1,2 after 15 minutes have passed since the start of operation. (Compare them by MPaG [PSIG] unit.)

- 1) When the difference between both pressures is within 0.25 MPaG [36 PSIG], both the high pressure sensor and the control board are normal.
- 2) When the difference between both pressures exceeds 0.25 MPaG [36 PSIG], the high pressure sensor has a problem. (performance deterioration)
- 3) When the pressure displayed on self-diagnosis LED1, 2 does not change, the high pressure sensor has a problem.

(3) Remove the high pressure sensor from the control board to check the pressure on the self-diagnosis LED1, 2.

- 1) When the pressure displayed on self-diagnosis LED1, 2 is between 0 and 0.098 MPaG [14 PSIG], the high pressure sensor has a problem.
- 2) When the pressure displayed on self-diagnosis LED1, 2 is approximately 5.0 MPaG [725 PSIG], the control board has a problem.

(4) Remove the high pressure sensor from the control board, and short-circuit between the pin 2 and pin 3 connectors (63HS) to check the pressure with self-diagnosis LED1, 2.

- 1) When the pressure displayed on the self-diagnosis LED1, 2 exceeds 5.0 MPaG [725 PSIG], the high pressure sensor has a problem.
- 2) If other than 1), the control board has a problem.

• High Pressure Sensor Configuration (63HS)

The high pressure sensor consists of the circuit shown in the figure below. If 5 VDC is applied between the red and the black wires, voltage corresponding to the pressure between the white and the black wires will be output, and the value of this voltage will be converted by the microprocessor. The output voltage is 0.078 V per 0.098 MPaG [14 PSIG].

Note: The pressure sensor on the body side is designed to connect to the connector. The connector pin number on the body side is different from that on the control board side.

	Body side	Control board side
Vcc	Pin 1	Pin 3
Vout	Pin 2	Pin 2
GND	Pin 3	Pin 1

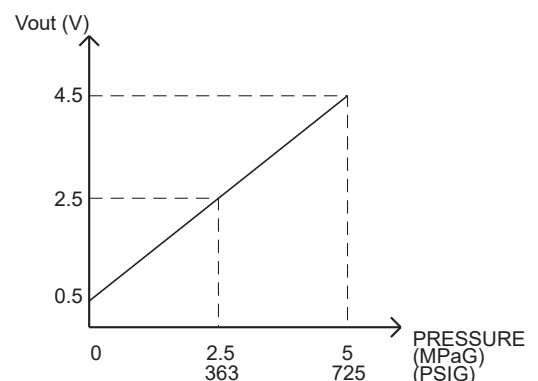
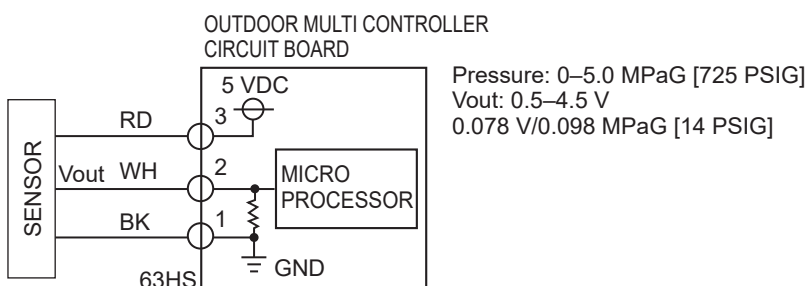

- ③—①: 5 V(DC)
②—①: Output Vout (DC)

<LOW PRESSURE SENSOR>

• Comparing the Low Pressure Sensor Measurement and Gauge Pressure

By configuring the digital display setting switch (SW1) as shown in the figure below, the pressure as measured by the low pressure sensor appears on the LED1 on the control board.

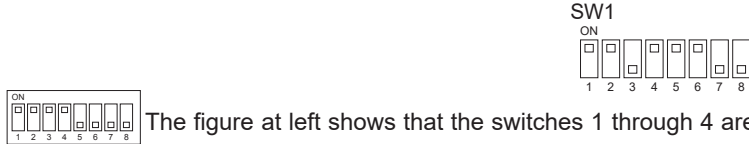

The figure at left shows that the switches 1 through 4 are set to ON and 5 through 8 are set to OFF.

- (1) While the outdoor unit is stopped, compare the gauge pressure and the pressure displayed on self-diagnosis LED1, 2.
 - 1) When the gauge pressure is between 0 and 0.098 MPaG [14 PSIG], internal pressure is caused due to gas leak.
 - 2) When the pressure displayed on self-diagnosis LED1, 2 is between 0 and 0.098 MPaG [14 PSIG], the connector may be defective or be disconnected. Check the connector and go to (4).
 - 3) When the outdoor temperature is 30°C [86°F] or less, and the pressure displayed on self-diagnosis LED1, 2 exceeds 1.7 MPaG [247 PSIG], go to (3).
When the outdoor temperature exceeds 30°C [86°F], and the pressure displayed on self-diagnosis LED1, 2 exceeds 1.7 MPaG [247 PSIG], go to (5).
 - 4) If other than 1), 2) or 3), compare the pressures while the sensor is running. Go to (2).
- (2) Compare the gauge pressure and the pressure displayed on self-diagnosis LED1, 2 after 15 minutes have passed since the start of operation. (Compare them by MPaG [PSIG] unit .)
 - 1) When the difference between both pressures is within 0.2 MPaG [29 PSIG], both the low pressure sensor and the control board are normal.
 - 2) When the difference between both pressures exceeds 0.2 MPaG [29 PSIG], the low pressure sensor has a problem. (performance deterioration)
 - 3) When the pressure displayed on the self-diagnosis LED1, 2 does not change, the low pressure sensor has a problem.
- (3) Remove the low pressure sensor from the control board to check the pressure with the self-diagnosis LED1, 2 display.
 - 1) When the pressure displayed on the self-diagnosis LED1,2 is between 0 and 0.098 MPaG [14 PSIG], the low pressure sensor has a problem.
 - 2) When the pressure displayed on self-diagnosis LED1, 2 is approximately 1.7 MPaG [247 PSIG], the control board has a problem.
- (4) Remove the low pressure sensor from the control board, and short-circuit between the pin 2 and pin 3 connectors (63LS) to check the pressure with the self-diagnosis LED1, 2.
 - 1) When the pressure displayed on the self-diagnosis LED1, 2 exceeds 1.7 MPaG [247 PSIG], the low pressure sensor has a problem.
 - 2) If other than 1), the control board has a problem.
- (5) Remove the high pressure sensor (63HS) from the control board, and insert it into the connector for the low pressure sensor (63LS) to check the pressure with the self-diagnosis LED1, 2.
 - 1) When the pressure displayed on the self-diagnosis LED1, 2 exceeds 1.7 MPaG [247 PSIG], the control board has a problem.
 - 2) If other than 1), go to (2).

• Low Pressure Sensor Configuration (63LS)

The low pressure sensor consists of the circuit shown in the figure below. If 5 VDC is applied between the red and the black wires, voltage corresponding to the pressure between the white and the black wires will be output, and the value of this voltage will be converted by the microprocessor. The output voltage is 0.173 V per 0.098 MPaG [14 PSIG].

Note: The pressure sensor on the body side is designed to connect to the connector. The connector pin number on the body side is different from that on the control board side.

	Body side	Control board side
Vcc	Pin 1	Pin 3
Vout	Pin 2	Pin 2
GND	Pin 3	Pin 1

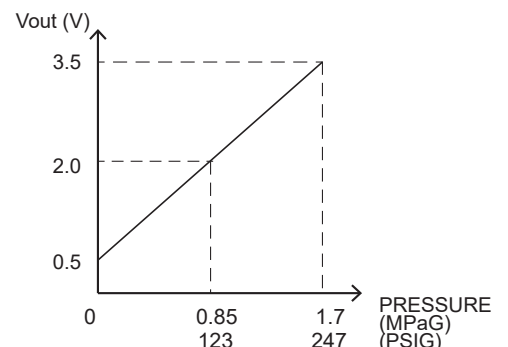
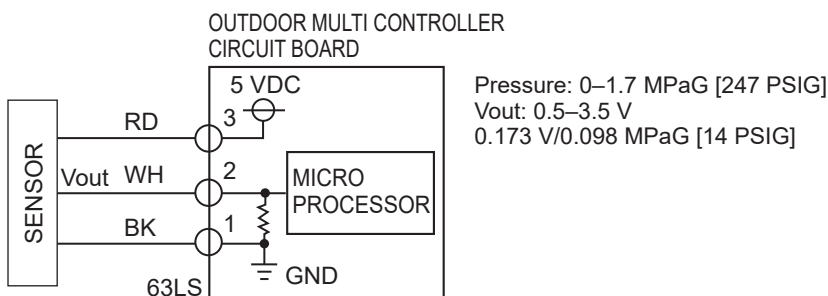

- ③—①: 5 V (DC)
②—①: Output Vout (DC)

8-8. TEST POINT DIAGRAM

Outdoor multi controller circuit board

<CAUTION> TEST POINT ① is high voltage.

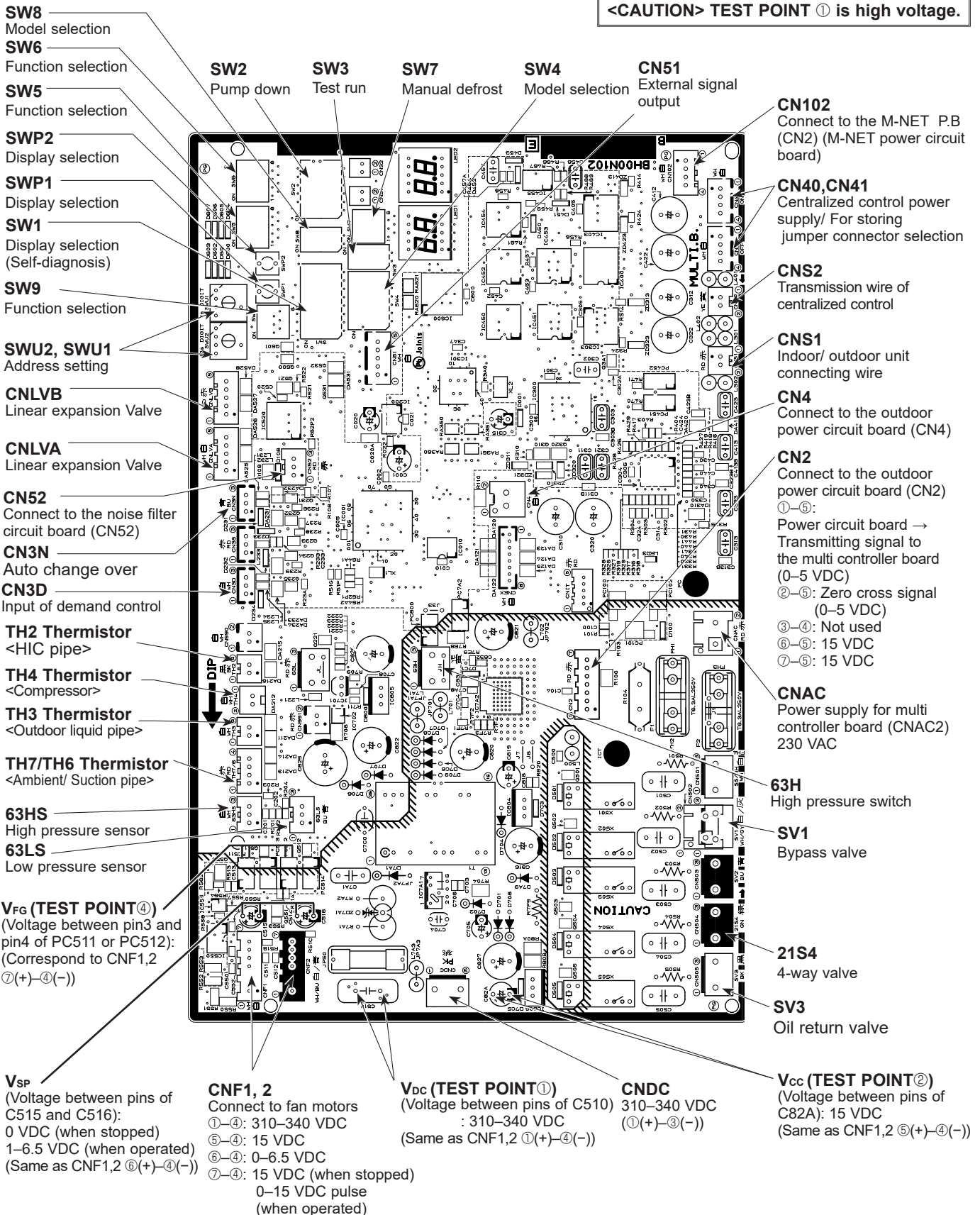

Outdoor power circuit board

Brief Check of POWER MODULE
 If they are short-circuited, it means that they are broken.
 Measure the resistance in the following points (connectors, etc.).

1. Check of Diode module (DS10)
L1-P1, L2-P1, L3-P1, L1-N1, L2-N1, L3-N1
2. Check of IPM (IC700)
P2-U, P2-V, P2-W, N2-U, N2-V, N2-W

Note: The marks L1, L2, L3, N1, N2, P1, P2, U, V and W shown in the diagram are not actually printed on the board.

TBU, TBV, TBW
 Connect to the compressor (MC)
 Voltage among phases:
 10-400 VAC

TBP2
 Connect to the DCL

TAB connector on X52CA
 Connect to the RS resistor

TBP1
 Connect to the DCL

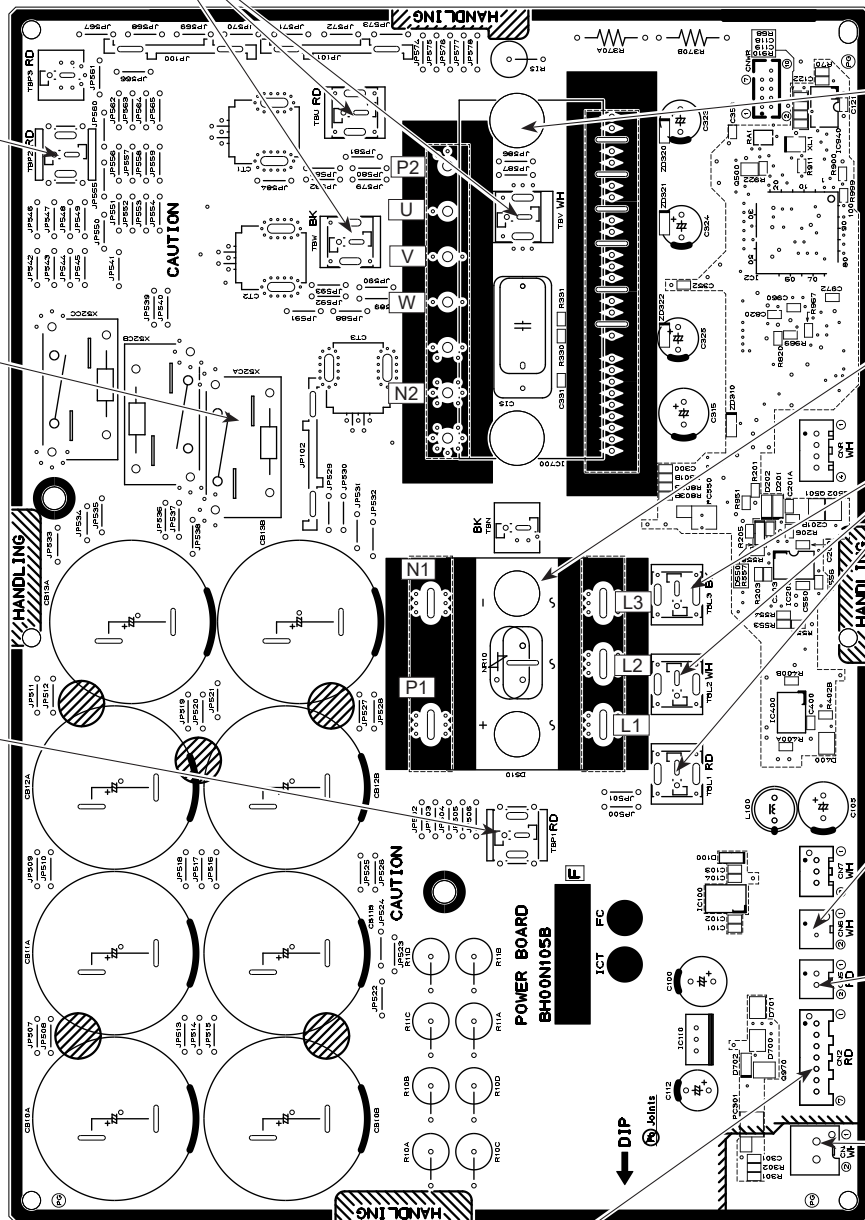

IPM (IC700)

Diode module (DS10)

TBL3
TBL2
TBL1
 Connect to the outdoor noise filter circuit board (LO1, LO2, LO3) 400 VAC

CN6
 Thermistor <Heat Sink> (TH8)

CN5
 Detection of primary current (Connect to the outdoor noise filter circuit board (CNCT))

CN4
 Connect to the outdoor controller circuit board (CN4)

CN2
 Connect to the outdoor controller circuit board (CN2)
 ①-⑤: Power circuit board → Transmitting signal to the controller board (0-5 VDC)
 ②-⑤: Zero cross signal (0-5 VDC)
 ③-④: Not used
 ⑥-⑤: 15 VDC
 ⑦-⑤: 15 VDC
 [⑤ : ⊖ ①, ②, ⑥, ⑦ : ⊕]

M-NET power circuit board

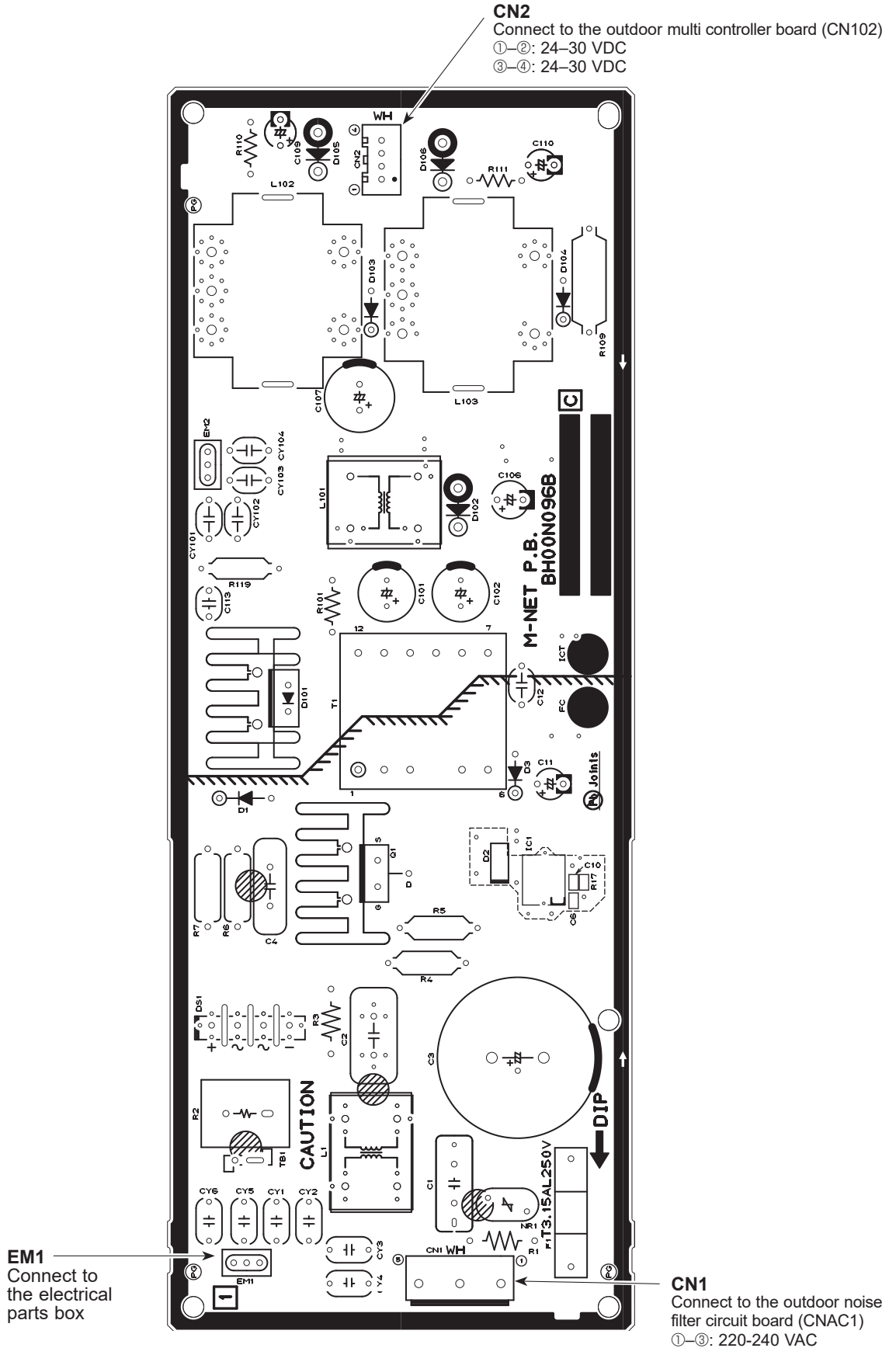

Outdoor noise filter circuit board

CNCT

Primary current
Connect to the outdoor power circuit board (CN5)

LO1, LO2, LO3 POWER SUPPLY

LO1-LO2/LO2-LO3/
LO3-LO1: 400 VAC input
Connect to the outdoor power circuit board (TBL1, TBL2, TBL3)

LI1, LI2, LI3, NI POWER SUPPLY

LI1-LI2/LI2-LI3/LI3-LI1: 400 VAC input
LI1-NI/LI2-NI/LI3-NI: 230 VAC input
Connect to the terminal block (TB1)

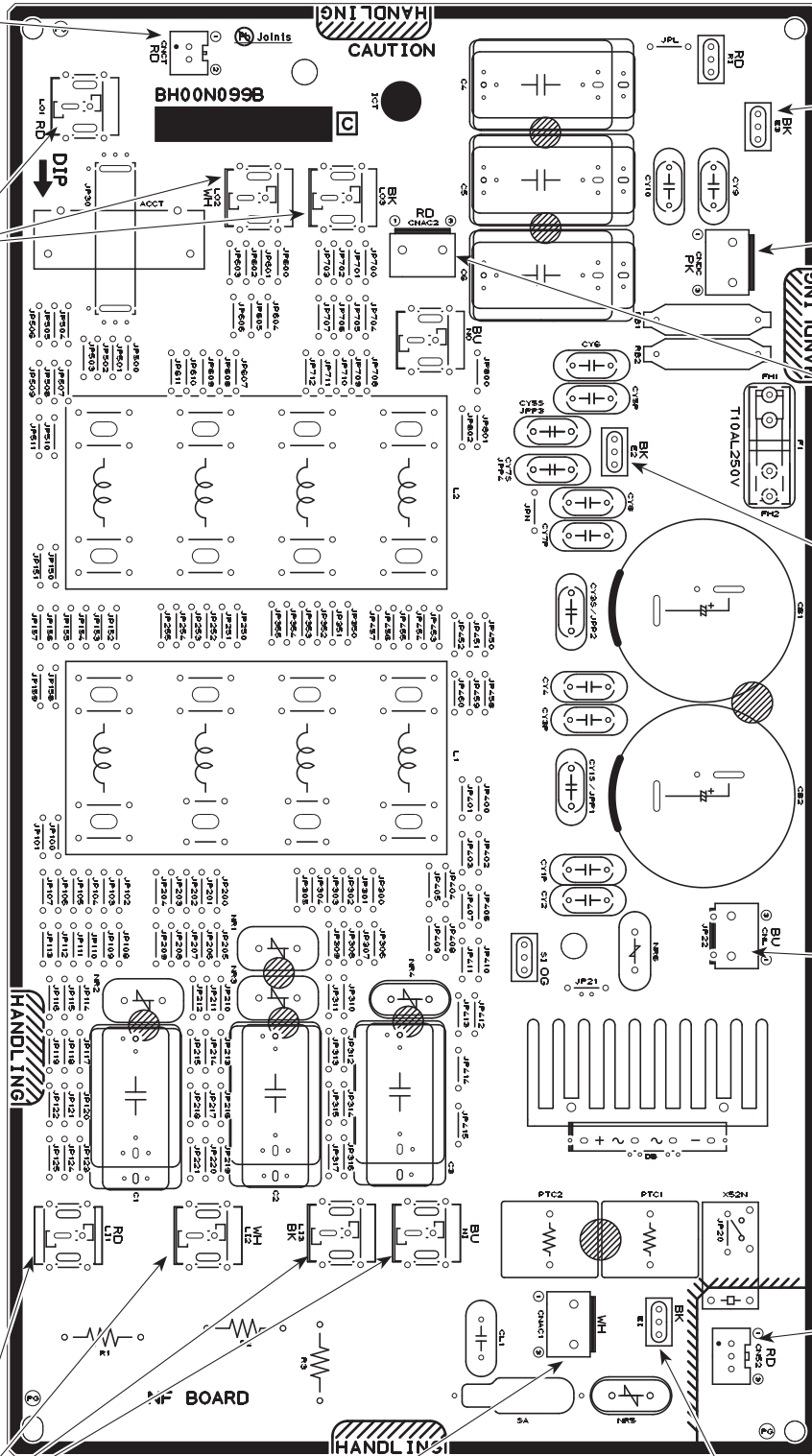

E3
Connect to the electrical parts box

CNDC
Connect to the outdoor multi controller circuit board (CNDC)

CNAC2 230 VAC
Connect to the outdoor multi controller circuit board (CNAC)

E2
Connect to the electrical parts box

CNL
Connect to the DCL2

CN52
Connect to the outdoor multi controller circuit board (CN52)

CNAC1 230 VAC
Connect to the M-NET power circuit board (CN1)

EI
Connect to the electrical parts box

8-9. OUTDOOR UNIT FUNCTIONS

SW: setting
0....OFF
1....ON

No.	SW1 setting 12345678	Display mode	Display on the LED1, 2 (display data)								Notes
			1	2	3	4	5	6	7	8	
0	00000000	Relay output display	Compressor operation	52C	21S4	SV1	SV2	SV3	-	Always lighting	ON: light on OFF: light off *When abnormality occurs, check display.
1	10000000	Check display	0000-9999 (Alternating display of addresses and check code)	No.2 unit check	No.3 unit check	No.4 unit check	No.5 unit check	No.6 unit check	No.7 unit check	No.8 unit check	Light on at time of abnormality
2	01000000	Indoor unit check status	No.9 unit check	No.10 unit check	No.11 unit check	No.12 unit check	No.13 unit check	No.14 unit check	No.15 unit check	No.16 unit check	
3	11000000		No.17 unit check	No.18 unit check	No.19 unit check	No.20 unit check	No.21 unit check	No.22 unit check	No.23 unit check	No.24 unit check	
4	00100000	No.25 unit check	No.26 unit check	No.27 unit check	No.28 unit check	No.29 unit check	No.30 unit check	-	-	-	
5	10100000	Protection input	High pressure abnormality	Superheat due to low discharge temperature	Compressor shell temperature abnormality	TH4 abnormality	TH3 abnormality	Outdoor fan rotation frequency abnormality	TH7 abnormality	TH8 abnormality	Display of detected microprocessor protection or abnormality
6	01100000	Protection input	Heat sink overheating	Compressor over current interception	Voltage abnormality	Insufficient refrigerant amount abnormality	Current sensor/primary current abnormality	63LS abnormality	63HS abnormality	start over current interception abnormality	
7	11100000	Protection input	Abnormality in the number of indoor units	Address double setting abnormality	Indoor unit capacity error	Over capacity	Indoor unit address error	Outdoor unit address error	Current sensor open/short	serial communication abnormality (outdoor unit)	
8	00010000	Abnormality delay display 1	High pressure abnormality delay	Superheat due to low discharge temperature delay	Compressor shell temperature abnormality delay	TH4 abnormality delay	TH3 abnormality delay	Outdoor fan rotation frequency abnormality delay	TH7 abnormality delay	TH8 abnormality delay	Display of all abnormalities remaining in abnormality delay
9	10010000	Abnormality delay display 2	Heat sink overheating delay	Compressor over current interception delay	Voltage abnormality delay	Insufficient refrigerant amount abnormality delay	Current sensor/primary current abnormality delay	63LS abnormality delay	63HS abnormality delay	start over current interception abnormality delay	
10	01010000	Abnormality delay display 3	63LS abnormality delay	TH2 abnormality delay	4-way valve abnormality delay	Delay caused by closed valve in cooling mode	Power module abnormality delay	TH6 abnormality delay	Current sensor open/short delay	Delay of failure in 12 VDC power supply circuit on power circuit board	
11	11010000	Abnormality delay history 1	High pressure abnormality delay	Superheat due to low discharge temperature delay	Compressor shell temperature abnormality delay	TH4 abnormality delay	TH3 abnormality delay	Outdoor fan rotation frequency abnormality delay	TH7 abnormality delay	TH8 abnormality delay	Display of all abnormalities remaining in abnormality delay
12	00110000	Abnormality delay history 2	Heat sink overheating delay	Compressor over current interception delay	Voltage abnormality delay	Insufficient refrigerant amount abnormality delay	Current sensor/primary current abnormality delay	63LS abnormality delay	63HS abnormality delay	start over current interception abnormality delay	
13	10110000	Abnormality delay history 3	63LS abnormality delay	TH2 abnormality delay	4-way valve abnormality delay	Delay caused by closed valve in cooling mode	Power module abnormality delay	TH6 abnormality delay	Current sensor open/short delay	Delay of failure in 12 VDC power supply circuit on power circuit board	
14	01110000	Abnormality code history 1 (the latest)	Abnormality delay	Discharge/Comp. temperature	Abnormality delay	Discharge/Comp. temperature	Abnormality delay	Abnormality delay	Abnormality delay	Abnormality delay	<ul style="list-style-type: none"> • Display of abnormalities up to present (including abnormality delays) • History record in 1 is the latest; records become older in sequence; history record in 10 is the oldest.
15	11110000	Abnormality code history 2	Discharge/Comp. temperature	Thermistor <Compressor>(TH4)	Discharge superheat (SHd)	Thermistor <Compressor>(TH4)	Discharge superheat (SHd)	Discharge superheat (SHd)	Discharge superheat (SHd)	Discharge superheat (SHd)	
16	00001000	Abnormality code history 3	Thermistor <Outdoor liquid pipe> (TH3)	Thermistor <Outdoor liquid pipe> (TH3)	Insufficient refrigerant	Thermistor <Outdoor liquid pipe> (TH3)	Insufficient refrigerant	Insufficient refrigerant	Insufficient refrigerant	Insufficient refrigerant	
17	10001000	Abnormality code history 4	Thermistor <Suction pipe> (TH6)	Thermistor <Suction pipe> (TH6)	4-way valve disconnection	Thermistor <Suction pipe> (TH6)	4-way valve disconnection	4-way valve disconnection	4-way valve disconnection	4-way valve disconnection	
18	01001000	Abnormality code history 5	Thermistor <Heat sink> (TH8)	Thermistor <Heat sink> (TH8)	Power synchronization signal	Thermistor <Heat sink> (TH8)	Power synchronization signal	Power synchronization signal	Power synchronization signal	Power synchronization signal	
19	11001000	Abnormality code history 6	Thermistor <Ambient> (TH7)	Thermistor <Ambient> (TH7)	Current sensor	Thermistor <Ambient> (TH7)	Current sensor	Current sensor	Current sensor	Current sensor	
20	00101000	Abnormality code history 7	Thermistor <HIC> (TH2)	Thermistor <HIC> (TH2)	Undervoltage	Thermistor <HIC> (TH2)	Undervoltage	Undervoltage	Undervoltage	Undervoltage	
21	10101000	Abnormality code history 8	Low pressure sensor	Low pressure sensor	Heat sink temperature	Low pressure sensor	Heat sink temperature	Heat sink temperature	Heat sink temperature	Heat sink temperature	
22	01101000	Abnormality code history 9	High pressure sensor (63H)	High pressure sensor (63H)	Power module (Start) over current	High pressure sensor (63H)	Power module (Start) over current	Power module (Start) over current	Power module (Start) over current	Power module (Start) over current	
23	11101000	Abnormality code history 10 (the oldest)	Compressor protector (TRS)	Compressor protector (TRS)	Failure in 12 VDC power supply circuit on power circuit board	Compressor protector (TRS)	Failure in 12 VDC power supply circuit on power circuit board	Failure in 12 VDC power supply circuit on power circuit board	Failure in 12 VDC power supply circuit on power circuit board	Failure in 12 VDC power supply circuit on power circuit board	

No.	SW1 setting	Display on the LED1, 2 (display data)								Notes	
		1	2	3	4	5	6	7	8		
24	00011000	Cumulative time	0-9999 (unit: 1 hour)								Display of cumulative compressor operating time
25	10011000	Cumulative time	0-9999 (unit: 10 hour)								Light ON / Light OFF
26	01011000	Outdoor unit operation display	Compressor energizing / no	Compressor operating prohibition / no	Compressor in operation / stop	Abnormality detection (check) / normal					
27	11011000	Indoor unit operation mode	No. 1 unit mode	No. 2 unit mode	No. 3 unit mode	No. 4 unit mode	No. 5 unit mode	No. 6 unit mode	No. 7 unit mode	No. 8 unit mode	
28	00111000		No. 9 unit mode	No. 10 unit mode	No. 11 unit mode	No. 12 unit mode	No. 13 unit mode	No. 14 unit mode	No. 15 unit mode	No. 16 unit mode	
29	10111000		No. 17 unit mode	No. 18 unit mode	No. 19 unit mode	No. 20 unit mode	No. 21 unit mode	No. 22 unit mode	No. 23 unit mode	No. 24 unit mode	
30	01111000		No. 25 unit mode	No. 26 unit mode	No. 27 unit mode	No. 28 unit mode	No. 29 unit mode	No. 30 unit mode	-	-	
31	11111000	Indoor unit operation display	No. 1 unit operation	No. 2 unit operation	No. 3 unit operation	No. 4 unit operation	No. 5 unit operation	No. 6 unit operation	No. 7 unit operation	No. 8 unit operation	
32	00001100		No. 9 unit operation	No. 10 unit operation	No. 11 unit operation	No. 12 unit operation	No. 13 unit operation	No. 14 unit operation	No. 15 unit operation	No. 16 unit operation	
33	10000100		No. 17 unit operation	No. 18 unit operation	No. 19 unit operation	No. 20 unit operation	No. 21 unit operation	No. 22 unit operation	No. 23 unit operation	No. 24 unit operation	
34	01000100		No. 25 unit operation	No. 26 unit operation	No. 27 unit operation	No. 28 unit operation	No. 29 unit operation	No. 30 unit operation	-	-	
35	11000100	Capacity code (No. 1 to 30 indoor units)	0-255								Address and display data are alternately displayed every second. Pressing SWP2 changes the displayed unit in ascending order; it returns to No. 1 after No. 30.
36	00100100	IC operation mode (No. 1 to 30 units)	STOP	Fan	Cooling thermo-ON	Cooling thermo-OFF	Heating thermo-ON	Heating thermo-OFF	-	-	
37	10100100	OC operation mode	Compressor ON/OFF	Heating/Cooling	Abnormal/normal	DEFROST/no	Refrigerant recovery / no	Excitation current / no	3-min delay / no	Light on / light off	
38	01100100	External connection status	CN3N1-3 input	CN3N1-2 input	CN3S1-2 input	CN3D1-3 input	CN3D1-2 input	-	-	Input: light off No input: light on	
39	11100100	Communication demand capacity	0-255 (%)								Display of communication demand capacity
40	00010100	Number of compressor ON/OFF	0000-9999 (unit: x10)								Display a count of compressor operation/stop
41	10010100	Compressor operating current	0-999.9 (Arms)								Display detected current
42	01010100	Input current of outdoor unit	0-999.9 (Arms)								Display cumulative time of thermo-ON operation
43	11010100	Thermo-ON operating time	0000-9999 (unit: x10)								Display total capacity code of indoor units with thermo-ON
44	00110100	Total capacity of thermo-ON	0-255								Display number of connected indoor units
45	10110100	Number of indoor units	0-255								Display bus voltage
46	01110100	DC bus voltage	0-9999 (V)								Display active LEV control
47	11110100	State of LEV/control	Cooling/Heating: Td overheating prevention	Cooling: SHd decrease prevention	Cooling/Heating: Min,Sj correction depends on Td	Cooling/Heating: Min,Sj correction depends on Shd	Heating: LEV opening correction depends on Pd	Heating: LEV opening correction depends on Td	Cooling: Correction of high compression ratio prevention	-	
48	00001100	State of compressor frequency control 1	Condensing temperature limit control	Compressor temperature control	-	Discharge temp. (heating) backup control	Pd abnormality control (heating)	Pd Back up control(heating)	Freeze prevention control at the beginning of SHd	Display active compressor frequency control (High pressure and overheating control: only when connected to Ecodan)	
49	10001100	State of compressor frequency control 2	Heat sink overheating prevention control	Secondary current control	Input current control	Unbalance control of 3-phase power supply	Frequency restrain of receipt voltage change	Low pressure decrease prevention	HZ-up inhibit control at the beginning of SHd	High pressure and overheating control	
50	01001100	Protection input	63LS abnormality	HIC abnormality	-	Frozen protection	4-way valve disconnection abnormality	Delay caused by closed valve in cooling mode	TH6 abnormality	Power module abnormality	
51	11001100	The second current value when microprocessor of P/OWER BOARD abnormality is detected	0-999.9 (Arms)								Display data at time of abnormality
52	00101100	Heat sink temperature when microprocessor of P/OWER BOARD abnormality is detected	-99.9-999.9 (°C)								

No.	SW1 setting	Display mode	Display on the LED1, 2 (display data)								Notes
			1	2	3	4	5	6	7	8	
53	10101100	Outdoor LEV-A opening pulse									Display of data at time of abnormality and abnormality delay
54	01101100	Outdoor LEV-A opening pulse abnormality delay									
55	11101100	Outdoor LEV-A opening pulse abnormality									
56	00011100	Outdoor LEV-B opening pulse	0-2000 (pulse)								
57	10011100	Outdoor LEV-B opening pulse abnormality delay									
58	01011100	Outdoor LEV-B opening pulse abnormality									
59	11011100	63LS (Low pressure)	-99.9-999.9 (Kg/cm ²)								
60	00111100	63LS abnormality delay	-99.9-999.9 (Kg/cm ²)								
61	10111100	63LS abnormality									
62	01111100	TH2 (HIC pipe)	-99.9-999.9 (°C)								
63	11111100	TH2 (HIC) abnormality delay									
64	00000010	TH2 (HIC) abnormality	-99.9-999.9 (°C)								
65	10000010	Operational frequency	0-255 (Hz)								
66	01000010	Target frequency	0-255 (Hz)								
67	11000010	Outdoor fan control step number	0-15								
68	00100010	Indoor LEV Opening pulse (No. 1 to 30 units)	0-2000 (pulse)								Address and display data are alternately displayed every second. Pressing SWP2 changes the displayed unit in ascending order; it returns to No. 1 after No. 30.
69	10100010	High pressure sensor (Pt)	-99.9-999.9 (Kg/cm ²)								
70	01100010	TH4 (Compressor) data									
71	11100010	TH6 (Suction pipe) data									
72	00010010	TH7 (Ambient) data	-99.9-999.9 (°C)								
73	10010010	TH3 (Outdoor liquid pipe) data									
74	01010010	TH8 (Heat sink) data									
75	11010010	TH23 (Gas) data (No. 1 to 30 indoor units)	-99.9-999.9 (°C)								
76	00110010	TH22 (Liquid) data (No. 1 to 30 indoor units)									
77	10110010	TH21 (Intake) data (No. 1 to 30 indoor units)	-99.9-999.9 (°C)								
78	01110010	Outdoor SC (cooling)	-99.9-999.9 (°C)								
79	11110010	Target subcool step	-2-4								
80	00001010	Indoor SC/SH (No. 1 to 30 units)	-99.9-999.9 (°C) during heating; subcool (SC)/during cooling: superheat (SH) (Fixed to "0" during cooling operation)								

No.	SW1 setting	Display mode	Display on the LED1, 2 (display data)								Notes	
			1	2	3	4	5	6	7	8		
81	10001010	Discharge superheat (SH)	-99.9~999.9 (°C)									Display of outdoor discharge superheat (SH) data
82	01001010	Target Ptdisplay (heating)	Pdm (0.0~30.0) (kgf/cm ²)									Display of all control target data
83	11001010	Target ET display (cooling)	ETm (-2.0~23.0) (°C)									
84	00101010	Target outdoor SC (cooling)	SCm (0.0~20.0) (°C)									Address and display data are alternately displayed every second. Pressing SWP2 changes the displayed unit in ascending order; it returns to No. 1 after No. 30.
85	10101010	Target indoor SC/SH (No. 1 to 30 units)	SCm/SHm (0.0~20.0) (°C)									
86	01101010	Actual frequency of abnormality delay	0~255 (Hz)									Display of actual frequency at time of abnormality delay
87	11101010	Fan step number at time of abnormality delay	0~15									Display of fan step number at time of abnormality delay
88	00011010	Indoor LEV opening pulse abnormality delay (No. 1 to 30 units)	0~2000 (pulse)									Address and display data are alternately displayed every second. Pressing SWP2 changes the displayed unit in ascending order; it returns to No. 1 after No. 30.
89	10011010	High pressure sensor data at time of abnormality delay	-99.9~999.9 (Kgf/cm ²)									
90	01011010	TH4 (Compressor) sensor data at time of abnormality delay										Display of data from high pressure sensor, all thermistors, and SC/SH at time of abnormality delay
91	11011010	TH6 (Suction pipe) sensor data at time of abnormality delay										
92	00111010	TH3 (Outdoor liquid pipe) sensor data at time of abnormality delay	-99.9~999.9 (°C)									
93	10111010	TH8 (Heat sink) sensor data at time of abnormality delay										
94	01111010	OC SC (cooling) at time of abnormality delay										
95	11111010	IC SC/SH at time of abnormality delay (No. 1 to 30 units)	-99.9~999.9(°C) During heating: subcool (SC) During cooling: superheat (SH) (Fixed to "0" during cooling operation)									
96	00000110	ROM version monitor	0.00~99.99 (ver)									Display of version data of ROM
97	10000110	ROM type										Display of ROM type
98	01000110	Check sum mode	0000~FFFF									Display of check sum code of ROM

No.	SW1 setting 12345678	Display mode	Display on the LED1, 2 (display data)								Notes
			1	2	3	4	5	6	7	8	
99	11000110	Backup heating determination value a									Disclosure is required only for the US.
100	00100110	Backup heating determination value b									
101	10100110	Backup heating determination value c									
102	01100110	Backup heating determination value d									
103	11100110	Detailed and latest history of voltage error (U9/4220)	-	Active filter abnormality	PAM error	Converter Fault	Power synchronization signal error	L1 open phase error	Under voltage error	Over voltage error	Flagging the latest history of U9 error
104	00010110	External connection status at time of abnormality delay	CN3N 1-3 input	CN3N 1-2 input	CN3S 1-2 input	CN3D 1-3 input	CN3D 1-2 input	-	-	-	Input: light off No input: light on
105	10010110	External connection status at time of abnormality	CN3N 1-3 input	CN3N 1-2 input	CN3S 1-2 input	CN3D 1-3 input	CN3D 1-2 input	-	-	-	Input: light off No input: light on
106	01010110	Actual frequency of abnormality	0-255 (Hz)								
107	11010110	Fan step number at time of abnormality	0-15								
108	00110110	Detailed and latest error history (UP/4220)	-	-	-	-	-	-	Failure in 12 VDC power supply circuit on power circuit board	Over current abnormality	Flagging the latest history of UP error
109	10110110	IC LEV opening pulse at time of abnormality (No. 1 to 30 units)	0-2000 (pulse)								
110	01110110	High pressure sensor data at time of abnormality	-99.9-999.9 (Kg/cm ²)								
111	11110110	TH4 (Compressor) sensor data at time of abnormality									
112	00001110	TH6 (Suction pipe) sensor data at time of abnormality									
113	10001110	TH3 (Outdoor liquid pipe) sensor data at time of abnormality	-99.9-999.9 (°C)								
114	01001110	TH8 (Heat sink) sensor data at time of abnormality									
115	11001110	OC SC (cooling) at time of abnormality									
116	00101110	IC SC/SH at time of abnormality (No. 1 to 30 units)	-99.9-999.9(°C) During heating: subcool (SC) During cooling: superheat (SH) (Fixed to "0" during cooling operation)								
			Address and display data are alternately displayed every second. Pressing SWP2 changes the displayed unit in ascending order; it returns to No. 1 after No. 30.								
			Display of data from High pressure sensor, all thermistors, and SC/SH at time of abnormality.								
			Address and display data are alternately displayed every second. Pressing SWP2 changes the displayed unit in ascending order; it returns to No. 1 after No. 30.								

This chapter provides an introduction to electrical wiring for the Power Multi series, together with notes concerning power wiring, wiring for control (transmission wires and remote controller wires), and the frequency converter.

9-1. OVERVIEW OF POWER WIRING

- (1) Use a separate power supply for the outdoor unit and indoor unit.
- (2) Bear in mind ambient conditions (ambient temperature, direct sunlight, rain water, etc.) when proceeding with the wiring and connections.
- (3) The wire size is the minimum value for metal conduit wiring. The power cord size should be 1 rank thicker consideration of voltage drops. Make sure the power-supply voltage does not drop more than 10%.
- (4) Specific wiring requirements should adhere to the wiring regulations of the region.
- (5) Power supply cords of parts of appliances for outdoor use shall not be lighter than polychloroprene sheathed flexible cord (design 60245 IEC57). For example, use wiring such as YZW.
- (6) Install an earth line longer than power cables.

⚠ Warning:

- Be sure to use specified wires to connect so that no external force is imparted to terminal connections. If connections are not fixed firmly, it may cause heating or fire.
- Be sure to use the appropriate type of overcurrent protection switch. Note that generated overcurrent may include some amount of direct current.

⚠ Caution:

- Some installation site may require attachment of an earth leakage breaker. If no earth leakage breaker is installed, it may cause an electric shock.
- Do not use anything other than breaker and fuse with correct capacity. Using fuse and wire or copper wire with too large capacity may cause a malfunction of unit or fire.
- Be sure to install N-Line. Without N-Line, it could cause damage to the unit.

9-2. WIRING OF MAIN POWER SUPPLY AND EQUIPMENT CAPACITY

9-2-1. Wiring diagram for main power supply

■ Schematic Drawing of Wiring : When NOT using a Branch Box (example)

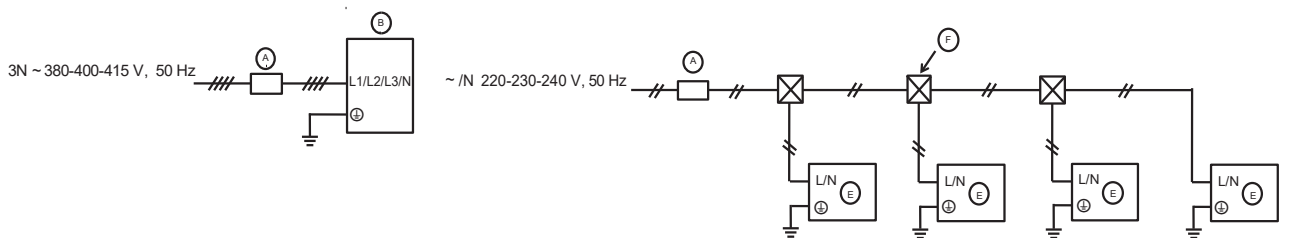

Note: The CITY MULTI series indoor unit cannot receive power supplied from an outdoor unit, so provide it with power separately.

- Ⓐ Switch (Breakers for Wiring and Current Leakage)
- Ⓑ Outdoor Unit
- Ⓒ Branch Box
- Ⓓ A-Control Indoor Unit
- Ⓔ CITY MULTI series Indoor unit
- Ⓕ Pull Box

■ Schematic Drawing of Wiring : When using Branch Boxes (example)

<When power is supplied to branch box from the outdoor unit>

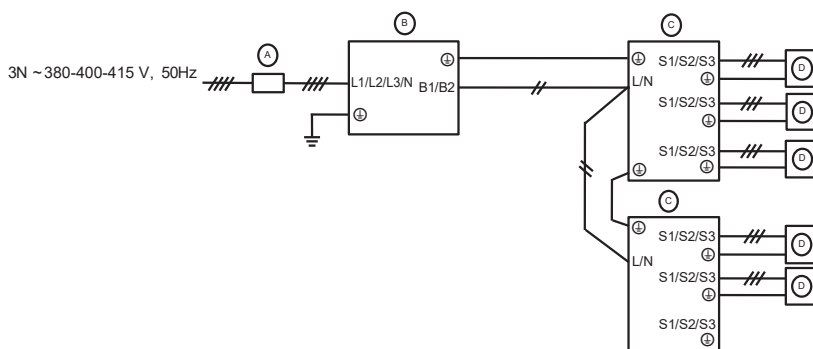

<When power is supplied to outdoor unit and branch box separately>

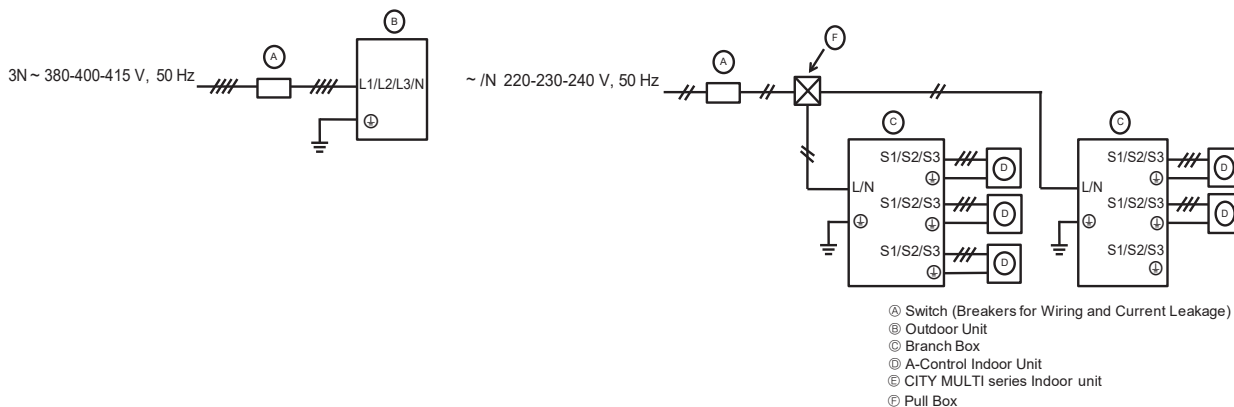

■ Schematic Drawing of Wiring : When using a Branch Box and CITY MULTI series indoor unit (example)

<When power is supplied to outdoor unit and branch box separately>

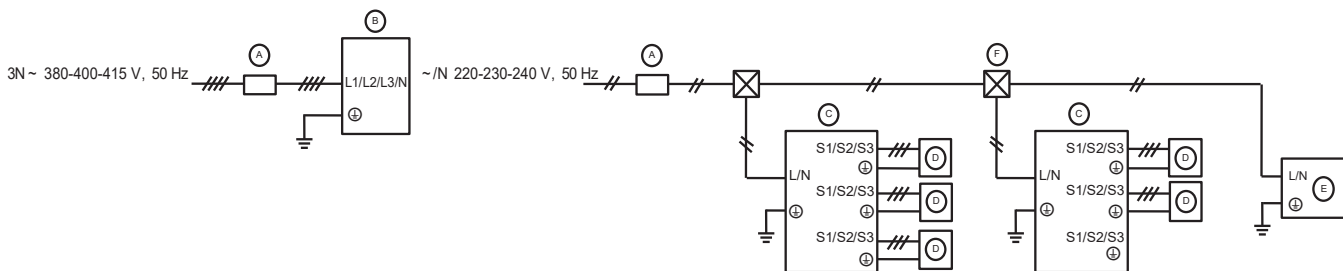

<When power is supplied to branch box from the outdoor unit>

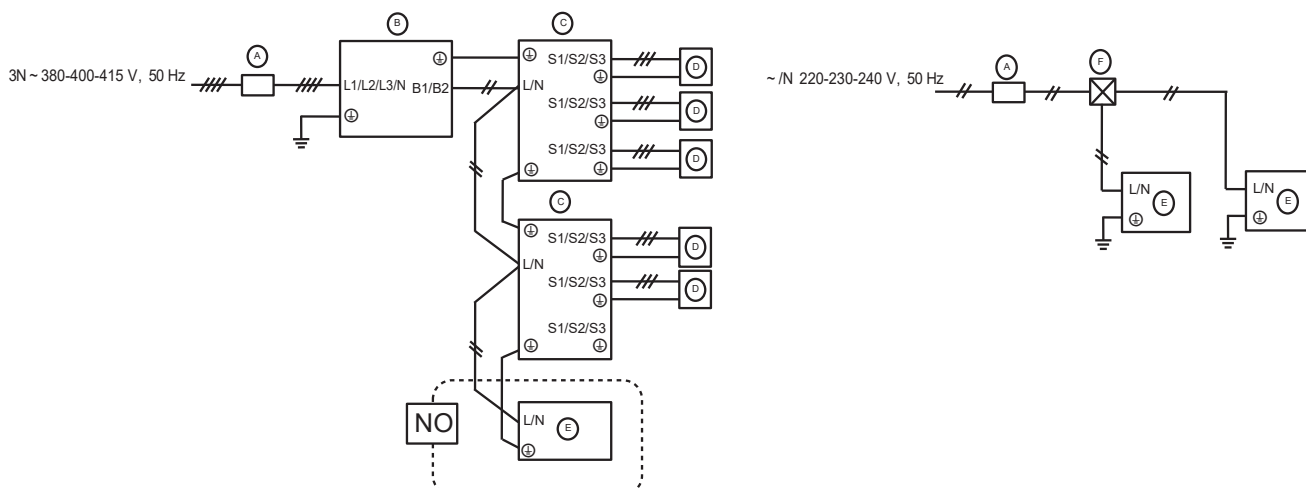

Note: The CITY MULTI series indoor unit cannot receive power supplied from an outdoor unit, so provide it with power separately.

9-2-2. Cross section area of Wire for Main Power and ON/OFF capacities

<When power is supplied separately>

Model	Power supply *2	Minimum Wire Cross-sectional area (mm ²)		Breaker for Wiring *1	Breaker for Current Leakage	
		Main Cable	Ground			
Outdoor unit	PUMY-P250YBM	3N~ 380-400-415 V 50 Hz	4.0	4.0	32 A	32 A 30 mA 0.1 sec. or less
	PUMY-P300YBM	3N~ 380-400-415 V 50 Hz	6.0	6.0	40 A	40 A 30 mA 0.1 sec. or less

<When power is supplied from the outdoor unit>

Model	Power supply *2	Minimum Wire Cross-sectional area (mm ²)		Breaker for Wiring *1	Breaker for Current Leakage	
		Main Cable	Ground			
Outdoor unit	PUMY-P250YBM	3N~ 380-400-415 V 50 Hz	6.0	6.0	40 A	40 A 30 mA 0.1 sec. or less
	PUMY-P300YBM	3N~ 380-400-415 V 50 Hz	6.0	6.0	40 A	40 A 30 mA 0.1 sec. or less

*1 A breaker with at least 3.0 mm contact separation in each poles shall be provided. Use non-fuse breaker (NF) or earth leakage breaker (NV).

*2 In multi-phase appliances, the colour of the neutral conductor of the supply cord, if any, shall be blue.

<Indoor units> When power is supplied to indoor unit and outdoor unit separately

Total operating current of the indoor unit	Minimum wire thickness (mm ²)			Ground-fault interrupter *1	Local switch (A)		Breaker for wiring (NFB)
	Main Cable	Branch	Ground		Capacity	Fuse	
F0 = 16 A or less *2	1.5	1.5	1.5	20 A current sensitivity *3	16	16	20
F0 = 25 A or less *2	2.5	2.5	2.5	30 A current sensitivity *3	25	25	30
F0 = 32 A or less *2	4.0	4.0	4.0	40 A current sensitivity *3	32	32	40

Apply to IEC61000-3-3 about max. permissive system impedance.

*1 The Ground-fault interrupter should support inverter circuit.

The Ground-fault interrupter should combine using of local switch or wiring breaker.

*2 Please take the larger of F1 or F2 as the value for F0.

F1 = Total operating maximum current of the indoor units × 1.2

F2 = {V1 × (Quantity of Type 1)/C} + {V1 × (Quantity of Type 2)/C} + {V1 × (Quantity of Type 3)/C} + ... + {V1 × (Quantity of Type 16)/C}

Connect to Branch box (PAC-MK-BC)

Indoor unit	V1	V2
Type 1 PEAD-M·JAA(D)	26.9	2.4
Type 2 SEZ-M·DA(L)2, PCA-M·KA2	19.8	
Type 3 SLZ-M·FA2, PLA-M·EA2	17.1	
Type 4 MSZ-AP·VG(K), MSZ-RW·VG-E1, MFZ-KT·VG, MFZ-KT·VG-E2, MLZ-KY·VG-E1, MSZ-LN·VG2, MSZ-EF·VG(-E2/ER2/ET2), MSZ-EF·VGK(-E1/ER1/ET1), MSZ-AY·VG(K)(P)	7.4	
Type 5 MSZ-FH·VE2	6.8	
Type 6 Branch box (PAC-MK-BC)	5.1	3

Connect to Connection kit (PAC-LV11M)

Indoor unit	V1	V2
Type 7 MSZ-EF·VG(-E2/ER2/ET2), MSZ-EF·VGK(-E1/ER2/ET1), MSZ-AP·VG(K), MFZ-KT·VG, MSZ-LN·VG2, MSZ-AY·VG(K)(P)	7.4	2.4
Type 8 MSZ-FH·VE2	6.8	
Type 9 Connection kit (PAC-LV11M)	3.5	

Connect to City Multi

Indoor unit	V1	V2
Type 10 PEFY-P·VMA(L)-E, PEFY-P·VMA(L)-E2, PEFY-P·VMA(L)-E3, PEFY-P·VMX(L)-E(1)	38	1.6
Type 11 PEFY-P40-140VMHS-E, PEFY-P·VMH-E2	26.8	
Type 12 PMFY-P·VBM-E, PLFY-P·VFM-E, PEFY-P·VMS1(L)-E, PCFY-P·VKM-E, PKFY-P·VKM-E, PKFY-P·VLM-E, PFFY-P·VKM-E2, PFFY-P·VCM-E	19.8	2.4
Type 13 PLFY-P·VEM-A, PLFY-M·VEM-E	17.1	
Type 14 PEFY-M·VMA(2)(L)-A, PEFY-M·VMA(L)-A1	18.6	3
Type 15 PEFY-P200/250VMHS-E, PEFY-P·VMHS-E-F	13.8	4.8
Type 16 PEFY-P·VMR-E-L/R, PFFY-P·VLEM-E, GUF-RD(H)4	0	0

C : Multiple of tripping current at tripping time 0.01s

Please pick up "C" from the tripping characteristic of the breaker.

<Example of "F2" calculation>

* Condition: PEFY-P·VMS1-E × 4 + PEFY-P·VMA-E × 1, C = 8 (refer to right sample chart)

$$F2 = 19.8 \times 4/8 + 38.0 \times 1/8 = 14.65$$

*3 Current sensitivity is calculated using the following formula.

$$G1 = \{V2 \times (\text{Quantity of Type 1})\} + \{V2 \times (\text{Quantity of Type 2})\} + \dots + \{V2 \times (\text{Quantity of Type 16})\} + \{V3 \times (\text{Wire length [km]})\}$$

G1	Current sensitivity
30 or less	30 mA 0.1 sec or less
100 or less	100 mA 0.1 sec or less

Wire thickness	V3
1.5 mm ²	48
2.5 mm ²	56
4.0 mm ²	66

Sample chart

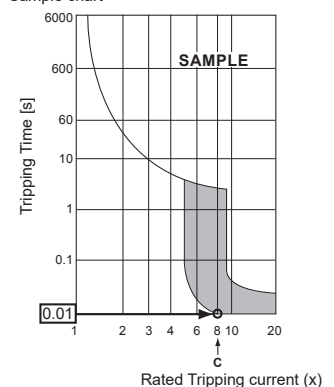

- Bear in mind ambient conditions (ambient temperature, direct sunlight, rain water, etc.) when proceeding with the wiring and connections.
- The wire size is the minimum value for metal conduit wiring. The power cord size should be 1 rank thicker consideration of voltage drops. Make sure the power-supply voltage does not drop more than 10%.
- Specific wiring requirements should adhere to the wiring regulations of the region.
- Power supply cords of parts of appliances for outdoor use shall not be lighter than polychloroprene sheathed flexible cord (design 60245 iec57). For example, use wiring such as YZW.
- Install an earth longer than other cables.

9-3. DESIGN FOR CONTROL WIRING

Please note that the types and numbers of control wires needed by the Power Multi series will depend on the remote controllers and whether they are linked with the system.

9-3-1. Selection number of control wires

		M-NET remote controller
Use		Remote controller used in system control operations • Group operation involving different refrigerant systems • Linked operation with upper control system
Remote controller → indoor unit		2-core wire (non-polar)
Transmission wires	Wires connecting → indoor units	
	Wires connecting → indoor units with outdoor unit	
	Wires connecting → outdoor units	

9-4. WIRING TRANSMISSION CABLES

9-4-1. Types of control cables

1. Wiring transmission cables

Types of transmission cables	Shielding wire (2-core) CVVS, CPEVS or MVVS
Cable diameter	More than 1.25 mm ²
Maximum wiring length	Within 200 m

2. M-NET Remote control cables

Types of remote control cables	Shielding wire (2-core) CVVS, CPEVS, or MVVS
Cable diameter	0.5 to 1.25 mm ²
Remarks	If the length exceeds 10 m, use a cable with the same specifications as transmission line wiring.

3. MA Remote control cables

Type of remote control cable	Sheathed 2-core cable (unshielded) CVV
Cable diameter	0.3 to 1.25 mm ² (0.75 to 1.25 mm ²)*
Remarks	Within 200 m

* Connected with simple remote controller.

9-4-2. Wiring examples

• Controller name, symbol and allowable number of controllers.

Name	Symbol	Allowable number of controllers	
Outdoor unit controller	OC	-	
Indoor unit controller	M-IC	PUMY-P250	1 to 30 units per 1 OC
		PUMY-P300	
	A-IC	PUMY-P250	2 to 12 units per 1 OC
		PUMY-P300	
Branch box	-	-	0 to 3 units per 1 OC
Remote controller	RC	M-NET RC	Maximum of 30 controllers for 1 OC (Cannot be connected if a branch box is used.)
		MA-RC	Maximum of 2 per group

9-5. SYSTEM SWITCH SETTING

In order to identify the destinations of signals to the outdoor units, indoor units, and remote controller of the Power Multi series, each microprocessor must be assigned an identification number (address). The addresses of outdoor units, indoor units, and remote controller must be set using their settings switches. Please consult the installation manual that comes with each unit for detailed information on setting procedures.

9-6. EXAMPLE EXTERNAL WIRING DIAGRAM FOR A BASIC SYSTEM

- Example of system when using an M-NET controller

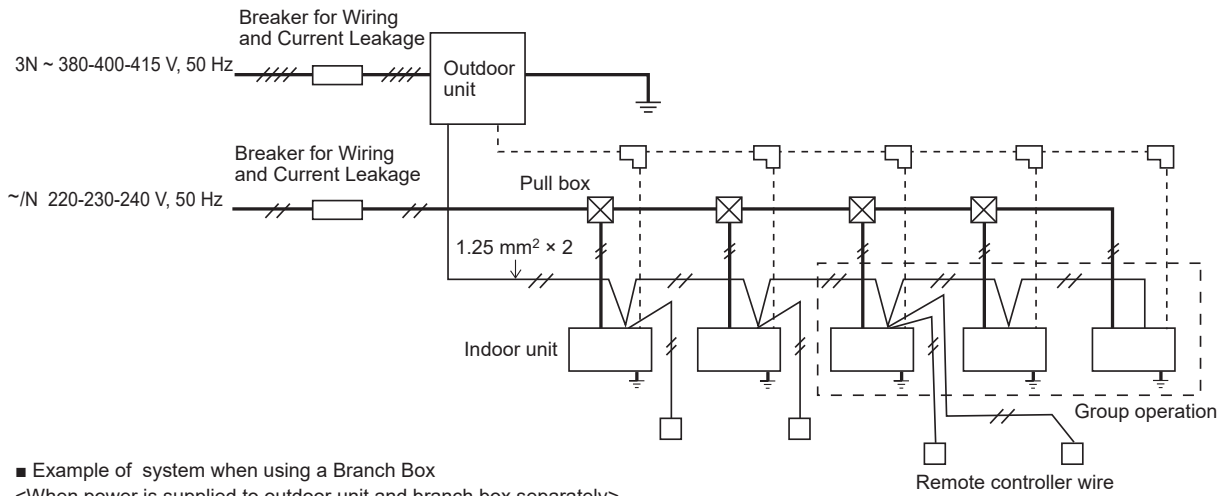

- Example of system when using a Branch Box

<When power is supplied to outdoor unit and branch box separately>

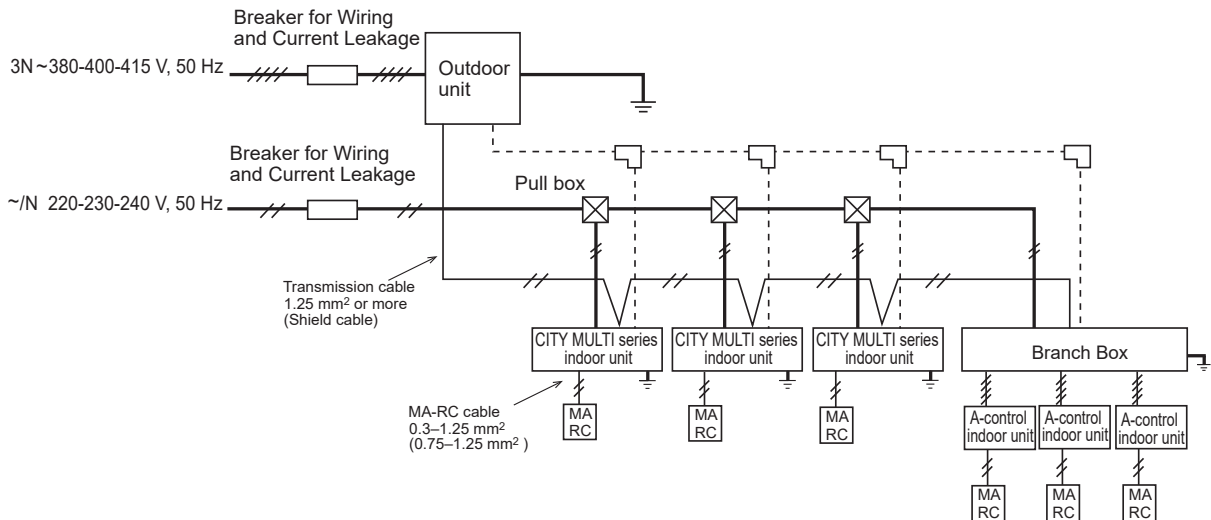

<When power is supplied to branch box from the outdoor unit>

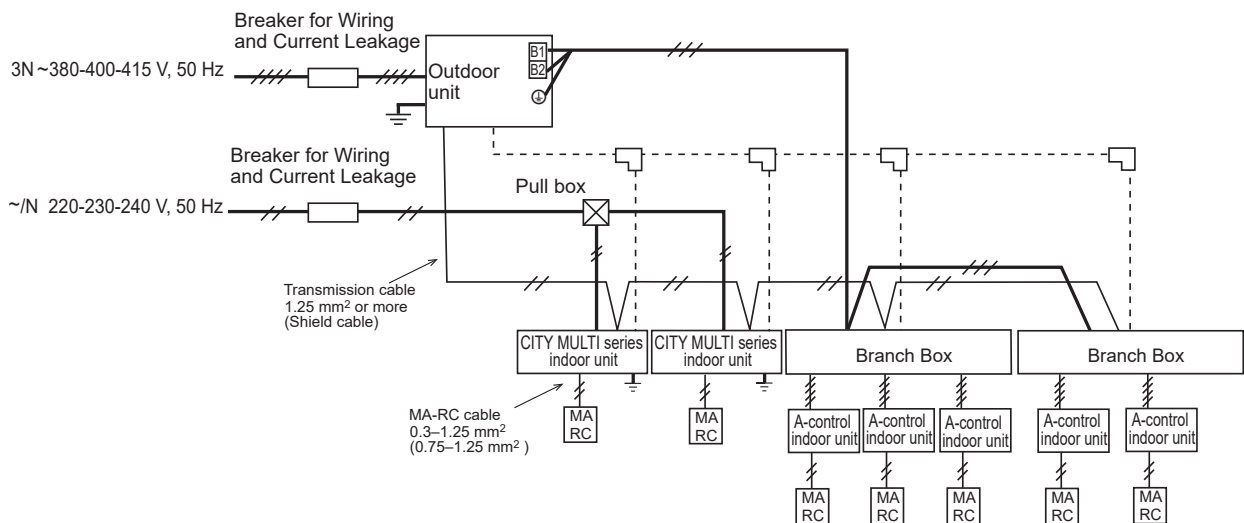

9-7. METHOD FOR OBTAINING ELECTRICAL CHARACTERISTICS WHEN A CAPACITY AGREEMENT IS TO BE SIGNED WITH AN ELECTRIC POWER COMPANY

The electrical characteristics of connected indoor unit system for air conditioning systems, including the Power Multi series, will depend on the arrangement of the indoor and outdoor units.

First read the data on the selected indoor and outdoor units and then use the following formulas to calculate the electrical characteristics before applying for a capacity agreement with the local electric power company.

9-7-1. Obtaining the electrical characteristics of the Power Multi series system

(1) Procedure for obtaining total power consumption

	Page numbers in this technical manual	Power consumption
Total power consumption of each indoor unit	See the technical manual of each indoor unit.	①
Power consumption of outdoor unit*	Standard capacity diagram— Refer to 4-3.	②
Total power consumption of system	See the technical manual of each indoor unit.	①+② <kW>

*The power consumption of the outdoor unit will vary depending on the total capacity of the selected indoor units.

(2) Method of obtaining total current

	Page numbers in this technical manual	Subtotal
Total current through each indoor unit	See the technical manual of each indoor unit.	①
Current through outdoor unit*	Standard capacity diagram — Refer to 4-3.	②
Total current through system	See the technical manual of each indoor unit.	①+② <A>

*The current through the outdoor unit will vary depending on the total capacity of the selected indoor units.

(3) Method of obtaining system power factor

Use the following formula and the total power and current obtained in parts ① and ② on the above tables to calculate the system power factor.

$$\text{System power factor} = \frac{(\text{Total system power consumption})}{(\text{Total system current} \times \text{voltage})} \times 100 \%$$

9-7-2. Applying to an electric power company for power and total current

Calculations should be performed separately for heating and cooling employing the same methods; use the largest resulting value in your application to the electric power company.

10-1. REFRIGERANT PIPING SYSTEM

Line-Branch Method
Connection Examples
(Connecting to 5 Indoor Units)

(A) Outdoor Unit
 (B) First Branch
 (C) Indoor unit

Permissible Length	Total Piping Length	$A+B+C+D+a+b+c+d+e \leq 310$ m
	Farthest Piping Length (L)	$A+B+C+D+e \leq 150$ m
	Farthest Piping Length After First Branch (ℓ)	$B+C+D+e \leq 30$ m
Permissible High/Low Difference	High/Low Difference in Indoor/Outdoor Section (H)	$H \leq 50$ m (In the case of outdoor unit is set higher than indoor unit)
		$H \leq 40$ m (In the case of outdoor unit is set lower than indoor unit)
	High/Low Difference in Indoor/Indoor Section (h)	$h \leq 15$ m

■ Selecting the Refrigerant Branch Kit
Use an optional branch piping kit (CMY-Y62-G-E).

■ Select Each Section of Refrigerant Piping

(1) Section From Outdoor Unit to First Branch (A)

(2) Sections From Branch to Indoor Unit (a,b,c,d,e)

(3) Section From Branch to Branch (B,C,D)

}

Each Section of Piping

Select the size from the table to the right.

(1) Refrigerant Piping Diameter In Section From Outdoor Unit to First Branch (Outdoor Unit Piping Diameter)

Model	Liquid pipe		Gas pipe
	L ≤ 90 m	L > 90 m	
P250	ø9.52*	ø12.7	ø22.2
	ø12.7	ø12.7	ø22.2
P300	All		ø22.2

(2) Refrigerant Piping Diameter In Section From Branch to Indoor Unit (Indoor Unit Piping Diameter)

Model number	Liquid pipe		Gas pipe
	a, b, c, d, e		
10 - 50	ø6.35	ø12.7	
63 - 140	ø9.52	ø15.88	
200	ø9.52	ø19.05	
250	ø9.52	ø22.2	

(3) Refrigerant Piping Diameter In Section From Branch to Branch (B, C, D)

Total down-stream capacity of indoor units	Liquid Pipe	Gas Pipe
- 16.0 kW	P250	L ≤ 90 m: ø9.52*
		L > 90 m: ø12.7
	P300	All: ø12.7
16.1 - 22.4 kW	P250	L ≤ 90 m: ø9.52*
		L > 90 m: ø12.7
	P300	All: ø12.7
22.5 kW -	P250	L ≤ 90 m: ø9.52*
		L > 90 m: ø12.7
	P300	All: ø12.7

L: The farthest piping length from the outdoor unit to an indoor unit.
 * ø12.7 when connecting the indoor unit for PEFY-P200 or P250.
 Note: When connecting the CONNECTION KIT (PAC-LV11M-J) and an M-series indoor unit, refer to the installation manual for the CONNECTION KIT when selecting the pipe size and piping length.

■ Additional refrigerant charge
Refrigerant for the extended piping is not included in the outdoor unit when the unit is shipped from the factory. Therefore, charge each refrigerant piping system with additional refrigerant at the installation site. In addition, in order to carry out service, enter the size and length of each liquid pipe and additional refrigerant charge amounts in the spaces provided on the "Refrigerant amount" plate on the outdoor unit.

■ Calculation of additional refrigerant charge

- Calculate the additional charge using the liquid pipe size and length of the extended piping.
- Calculate the additional refrigerant charge using the procedure shown to the right, and charge with the additional refrigerant.
- For amounts less than 0.1 kg, round up the calculated additional refrigerant charge.
(For example, if the calculated charge is 15.92 kg, round up the charge to 16.0 kg.)
- The amount of additional refrigerant which is calculated from the total capacity of indoor units and the combination of extended pipes must not be over 22.8 kg.
(Refer to 2-1 for the capacity of indoor units, and above for extended piping.)

<Additional charge>

Pipe size Liquid pipe ø6.35 (m) × 19.0 (g/m)	+	Pipe size Liquid pipe ø9.52 (m) × 50.0 (g/m)	+	Pipe size Liquid pipe ø12.7 (m) × 92.0 (g/m)	+
---	---	---	---	---	---

Included refrigerant amount when shipped from the factory

Included refrigerant amount
9.3 kg

Calculation example

Outdoor model: P250 A + B + C + D: ø9.52 30 m

1: P63 (7.1 kW) a: ø9.52 15 m

2: P63 (7.1 kW) b: ø9.52 10 m

3: P63 (7.1 kW) c: ø9.52 10 m

4: P63 (7.1 kW) d: ø9.52 10 m

5: P40 (4.5 kW) e: ø6.35 15 m

The total length of each pipe size is as follows:
 ø9.52: A + B + C + D + a + b + c + d = 75 m
 ø6.35: e = 15 m

The total capacity of connected indoor units is as follows:
 7.1 + 7.1 + 7.1 + 7.1 + 4.5 = 32.9 (kW)

Therefore, the additional charge is as follows:
 $15 \times \frac{19.0}{1000} + 75 \times \frac{50.0}{1000} + 4.0 = 8.1$ kg (round up)

Total capacity of connected indoor units	Amount for the indoor units
- 16.0 kW	2.5 kg
16.1 - 27.0 kW	3.0 kg
27.1 - 31.0 kW	3.5 kg
31.1 - 34.0 kW	4.0 kg
34.1 - 36.5 kW	4.5 kg
36.6 - 39.0 kW	5.0 kg
39.1 - 41.0 kW	5.5 kg
41.1 kW -	6.1 kg

At the conditions below:

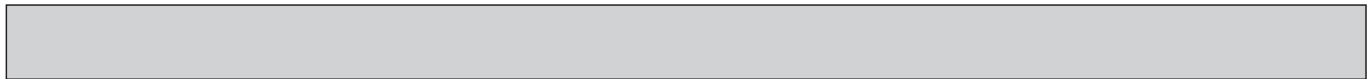

Header-Branch Method
 Connection Examples
 (Connecting to 6 Indoor Units)

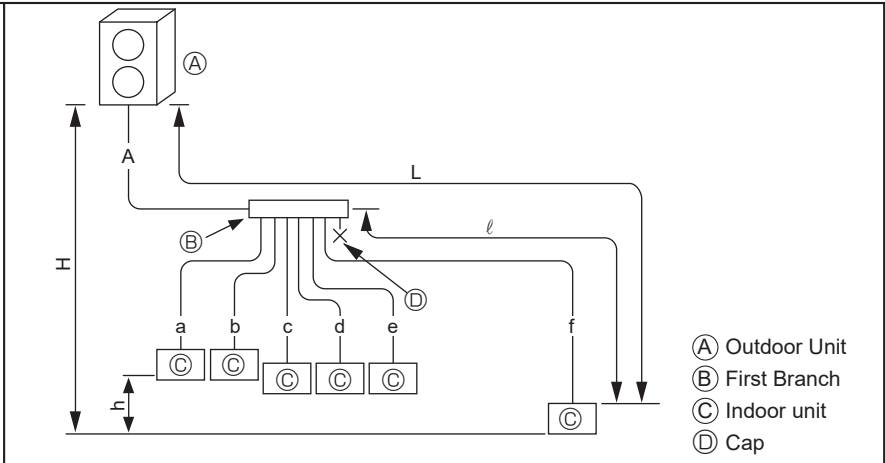

- (A) Outdoor Unit
- (B) First Branch
- (C) Indoor unit
- (D) Cap

Permissible Length	Total Piping Length	$A+a+b+c+d+e+f \leq 310$ m
	Farthest Piping Length (L)	$A+f \leq 150$ m
	Farthest Piping Length After First Branch (l)	$f \leq 30$ m
Permissible High/Low Difference	High/Low Difference in Indoor/Outdoor Section (H)	$H \leq 50$ m (In the case of outdoor unit is set higher than indoor unit)
	High/Low Difference in Indoor/Indoor Section (h)	$H \leq 40$ m (In the case of outdoor unit is set lower than indoor unit)
	High/Low Difference in Indoor/Indoor Section (h)	$h \leq 15$ m

■ **Selecting the Refrigerant Branch Kit**

Please select branching kit, which is sold separately, from the table below.
 (The kit comprises sets for use with liquid pipes and for use with gas pipes.)

Branch header (4 branches)	Branch header (8 branches)
CMY-Y64-G-E	CMY-Y68-G-E

■ **Select Each Section of Refrigerant Piping**

(1) Section From Outdoor Unit to First Branch (A)
 (2) Sections From Branch to Indoor Unit (a,b,c,d,e,f)

} Each Section of Piping

Select the size from the table to the right.

<p>(1) Refrigerant Piping Diameter In Section From Outdoor Unit to First Branch (Outdoor Unit Piping Diameter)</p> <table border="1" style="width: 100%; text-align: center;"> <thead> <tr> <th colspan="2" style="text-align: left;">A</th> <th colspan="2" style="text-align: right;">(mm)</th> </tr> <tr> <th style="text-align: left;">Model</th> <th style="text-align: left;">L</th> <th style="text-align: left;">A Liquid pipe</th> <th style="text-align: left;">B Gas pipe</th> </tr> </thead> <tbody> <tr> <td rowspan="2">P250</td> <td>$L \leq 90$ m</td> <td>$\phi 9.52^*$</td> <td>$\phi 22.2$</td> </tr> <tr> <td>$L > 90$ m</td> <td>$\phi 12.7$</td> <td>$\phi 22.2$</td> </tr> <tr> <td>P300</td> <td>All</td> <td>$\phi 12.7$</td> <td>$\phi 22.2$</td> </tr> </tbody> </table> <p>L: The farthest piping length from the outdoor unit to an indoor unit. * $\phi 12.7$ when connecting the indoor unit for PEFY-P200 or P250.</p> <p>Note: When connecting the CONNECTION KIT (PAC-LV11M-J) and an M-series indoor unit, refer to the installation manual for the CONNECTION KIT when selecting the pipe size and piping length.</p>	A		(mm)		Model	L	A Liquid pipe	B Gas pipe	P250	$L \leq 90$ m	$\phi 9.52^*$	$\phi 22.2$	$L > 90$ m	$\phi 12.7$	$\phi 22.2$	P300	All	$\phi 12.7$	$\phi 22.2$	<p>(2) Refrigerant Piping Diameter In Section From Branch to Indoor Unit (Indoor Unit Piping Diameter)</p> <table border="1" style="width: 100%; text-align: center;"> <thead> <tr> <th colspan="3" style="text-align: left;">a, b, c, d, e, f</th> <th colspan="2" style="text-align: right;">(mm)</th> </tr> <tr> <th style="text-align: left;">Model number</th> <th style="text-align: left;">Liquid pipe</th> <th style="text-align: left;">Gas pipe</th> <th colspan="2"></th> </tr> </thead> <tbody> <tr> <td>10 - 50</td> <td>$\phi 6.35$</td> <td>$\phi 12.7$</td> <td colspan="2"></td> </tr> <tr> <td>63 - 140</td> <td>$\phi 9.52$</td> <td>$\phi 15.88$</td> <td colspan="2"></td> </tr> <tr> <td>200</td> <td>$\phi 9.52$</td> <td>$\phi 19.05$</td> <td colspan="2"></td> </tr> <tr> <td>250</td> <td>$\phi 9.52$</td> <td>$\phi 22.2$</td> <td colspan="2"></td> </tr> </tbody> </table>	a, b, c, d, e, f			(mm)		Model number	Liquid pipe	Gas pipe			10 - 50	$\phi 6.35$	$\phi 12.7$			63 - 140	$\phi 9.52$	$\phi 15.88$			200	$\phi 9.52$	$\phi 19.05$			250	$\phi 9.52$	$\phi 22.2$		
A		(mm)																																																
Model	L	A Liquid pipe	B Gas pipe																																															
P250	$L \leq 90$ m	$\phi 9.52^*$	$\phi 22.2$																																															
	$L > 90$ m	$\phi 12.7$	$\phi 22.2$																																															
P300	All	$\phi 12.7$	$\phi 22.2$																																															
a, b, c, d, e, f			(mm)																																															
Model number	Liquid pipe	Gas pipe																																																
10 - 50	$\phi 6.35$	$\phi 12.7$																																																
63 - 140	$\phi 9.52$	$\phi 15.88$																																																
200	$\phi 9.52$	$\phi 19.05$																																																
250	$\phi 9.52$	$\phi 22.2$																																																

■ **Additional refrigerant charge** Refer to the same section in the previous page.

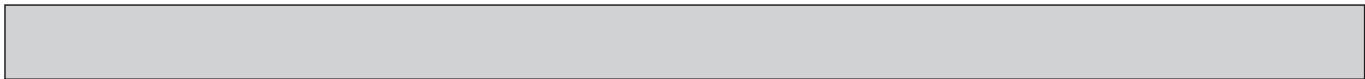

<p>Method of Combined Branching of Lines and Headers Connection Examples (Connecting to 5 Indoor Units)</p>																																																																					
Permissible Length	Total Piping Length	$A+B+C+a+b+c+d+e \leq 310\text{m}$																																																																			
	Farthest Piping Length (L)	$A+B+b \leq 150\text{m}$																																																																			
	Farthest Piping Length After First Branch (l)	$B+b \leq 30\text{m}$																																																																			
Permissible High/Low Difference	High/Low Difference in Indoor/Outdoor Section (H)	$H \leq 50\text{ m}$ (In the case of outdoor unit is set higher than indoor unit)																																																																			
	High/Low Difference in Indoor/Indoor Section (h)	$h \leq 15\text{ m}$																																																																			
<p>■ Selecting the Refrigerant Branch Kit</p>		<p>Please select branching kit, which is sold separately, from the table below. (The kit comprises sets for use with liquid pipes and for use with gas pipes.)</p> <table border="1"> <thead> <tr> <th>Branch Joint</th> <th>Branch header (4 branches)</th> <th>Branch header (8 branches)</th> </tr> </thead> <tbody> <tr> <td>CMY-Y62-G-E</td> <td>CMY-Y64-G-E</td> <td>CMY-Y68-G-E</td> </tr> </tbody> </table>		Branch Joint	Branch header (4 branches)	Branch header (8 branches)	CMY-Y62-G-E	CMY-Y64-G-E	CMY-Y68-G-E																																																												
Branch Joint	Branch header (4 branches)	Branch header (8 branches)																																																																			
CMY-Y62-G-E	CMY-Y64-G-E	CMY-Y68-G-E																																																																			
<p>■ Select Each Section of Refrigerant Piping</p> <p>(1) Section From Outdoor Unit to First Branch (A) (2) Sections From Branch to Indoor Unit (a,b,c,d,e) (3) Section From Branch to Branch (B,C)</p> <p style="text-align: right;">} Each Section of Piping</p> <p>Select the size from the table to the right.</p>		<p>(1) Refrigerant Piping Diameter In Section From Outdoor Unit to First Branch (Outdoor Unit Piping Diameter) (mm)</p> <table border="1"> <thead> <tr> <th>Model</th> <th>Liquid pipe</th> <th>Gas pipe</th> </tr> </thead> <tbody> <tr> <td rowspan="2">P250</td> <td>$L \leq 90\text{ m}$</td> <td>$\phi 9.52^*$</td> <td>$\phi 22.2$</td> </tr> <tr> <td>$L > 90\text{ m}$</td> <td>$\phi 12.7$</td> <td>$\phi 22.2$</td> </tr> <tr> <td>P300</td> <td>All</td> <td>$\phi 12.7$</td> <td>$\phi 22.2$</td> </tr> </tbody> </table> <p>(2) Refrigerant Piping Diameter In Section From Branch to Indoor Unit (Indoor Unit Piping Diameter) (mm)</p> <table border="1"> <thead> <tr> <th>Model number</th> <th>Liquid pipe</th> <th>Gas pipe</th> </tr> </thead> <tbody> <tr> <td>10 – 50</td> <td>$\phi 6.35$</td> <td>$\phi 12.7$</td> </tr> <tr> <td>63 – 140</td> <td>$\phi 9.52$</td> <td>$\phi 15.88$</td> </tr> <tr> <td>200</td> <td>$\phi 9.52$</td> <td>$\phi 19.05$</td> </tr> <tr> <td>250</td> <td>$\phi 9.52$</td> <td>$\phi 22.2$</td> </tr> </tbody> </table> <p>(3) Refrigerant Piping Diameter In Section From Branch to Branch (B, C, D) (mm)</p> <table border="1"> <thead> <tr> <th rowspan="2">Total down-stream capacity of indoor units</th> <th rowspan="2">Model</th> <th colspan="2">Liquid pipe</th> <th rowspan="2">Gas pipe</th> </tr> <tr> <th>$L \leq 90\text{ m}$</th> <th>$L > 90\text{ m}$</th> </tr> </thead> <tbody> <tr> <td rowspan="3">– 16.0 kW</td> <td rowspan="2">P250</td> <td>$L \leq 90\text{ m}$</td> <td>$\phi 9.52^*$</td> <td rowspan="3">$\phi 15.88$</td> </tr> <tr> <td>$L > 90\text{ m}$</td> <td>$\phi 12.7$</td> </tr> <tr> <td>P300</td> <td>All</td> <td>$\phi 12.7$</td> </tr> <tr> <td rowspan="3">16.1 – 22.4 kW</td> <td rowspan="2">P250</td> <td>$L \leq 90\text{ m}$</td> <td>$\phi 9.52^*$</td> <td rowspan="3">$\phi 19.05$</td> </tr> <tr> <td>$L > 90\text{ m}$</td> <td>$\phi 12.7$</td> </tr> <tr> <td>P300</td> <td>All</td> <td>$\phi 12.7$</td> </tr> <tr> <td rowspan="3">22.5 kW –</td> <td rowspan="2">P250</td> <td>$L \leq 90\text{ m}$</td> <td>$\phi 9.52^*$</td> <td rowspan="3">$\phi 22.2$</td> </tr> <tr> <td>$L > 90\text{ m}$</td> <td>$\phi 12.7$</td> </tr> <tr> <td>P300</td> <td>All</td> <td>$\phi 12.7$</td> </tr> </tbody> </table> <p>L: The farthest piping length from the outdoor unit to an indoor unit. * $\phi 12.7$ when connecting the indoor unit for PEFY-P200 or P250. Note: When connecting the CONNECTION KIT (PAC-LV11M-J) and an M-series indoor unit, refer to the installation manual for the CONNECTION KIT when selecting the pipe size and piping length.</p>		Model	Liquid pipe	Gas pipe	P250	$L \leq 90\text{ m}$	$\phi 9.52^*$	$\phi 22.2$	$L > 90\text{ m}$	$\phi 12.7$	$\phi 22.2$	P300	All	$\phi 12.7$	$\phi 22.2$	Model number	Liquid pipe	Gas pipe	10 – 50	$\phi 6.35$	$\phi 12.7$	63 – 140	$\phi 9.52$	$\phi 15.88$	200	$\phi 9.52$	$\phi 19.05$	250	$\phi 9.52$	$\phi 22.2$	Total down-stream capacity of indoor units	Model	Liquid pipe		Gas pipe	$L \leq 90\text{ m}$	$L > 90\text{ m}$	– 16.0 kW	P250	$L \leq 90\text{ m}$	$\phi 9.52^*$	$\phi 15.88$	$L > 90\text{ m}$	$\phi 12.7$	P300	All	$\phi 12.7$	16.1 – 22.4 kW	P250	$L \leq 90\text{ m}$	$\phi 9.52^*$	$\phi 19.05$	$L > 90\text{ m}$	$\phi 12.7$	P300	All	$\phi 12.7$	22.5 kW –	P250	$L \leq 90\text{ m}$	$\phi 9.52^*$	$\phi 22.2$	$L > 90\text{ m}$	$\phi 12.7$	P300	All	$\phi 12.7$
Model	Liquid pipe	Gas pipe																																																																			
P250	$L \leq 90\text{ m}$	$\phi 9.52^*$	$\phi 22.2$																																																																		
	$L > 90\text{ m}$	$\phi 12.7$	$\phi 22.2$																																																																		
P300	All	$\phi 12.7$	$\phi 22.2$																																																																		
Model number	Liquid pipe	Gas pipe																																																																			
10 – 50	$\phi 6.35$	$\phi 12.7$																																																																			
63 – 140	$\phi 9.52$	$\phi 15.88$																																																																			
200	$\phi 9.52$	$\phi 19.05$																																																																			
250	$\phi 9.52$	$\phi 22.2$																																																																			
Total down-stream capacity of indoor units	Model	Liquid pipe		Gas pipe																																																																	
		$L \leq 90\text{ m}$	$L > 90\text{ m}$																																																																		
– 16.0 kW	P250	$L \leq 90\text{ m}$	$\phi 9.52^*$	$\phi 15.88$																																																																	
		$L > 90\text{ m}$	$\phi 12.7$																																																																		
	P300	All	$\phi 12.7$																																																																		
16.1 – 22.4 kW	P250	$L \leq 90\text{ m}$	$\phi 9.52^*$	$\phi 19.05$																																																																	
		$L > 90\text{ m}$	$\phi 12.7$																																																																		
	P300	All	$\phi 12.7$																																																																		
22.5 kW –	P250	$L \leq 90\text{ m}$	$\phi 9.52^*$	$\phi 22.2$																																																																	
		$L > 90\text{ m}$	$\phi 12.7$																																																																		
	P300	All	$\phi 12.7$																																																																		
<p>■ Additional refrigerant charge</p>		<p>Refer to the same section in the previous page.</p>																																																																			

Branch box Method
Connection Examples
 (Connecting to 12 Indoor Units)

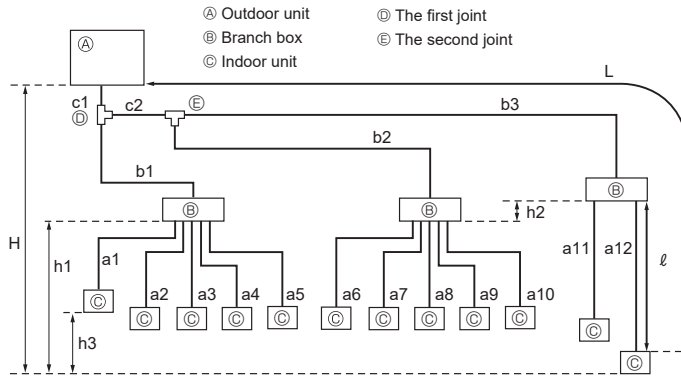

Permissible length (one-way)	Total piping length	$c1 + c2 + b1 + b2 + b3 + a1 + a2 + a3 + a4 + a5 + a6 + a7 + a8 + a9 + a10 + a11 + a12 \leq 240$ m
	Farthest piping length (L)	$c1 + c2 + b3 + a12 \leq 80$ m
	Piping length between outdoor unit and branch boxes	$c1 + c2 + b1 + b2 + b3 \leq 95$ m
	Farthest branch box from the first joint	$c2 + b3 \leq 30$ m
	Farthest piping length after branch box (ℓ)	$a12 \leq 25$ m
Permissible height difference (one-way)	In indoor/outdoor section (H) *1	$H \leq 50$ m (In the case of outdoor unit is set higher than indoor unit) $H \leq 40$ m (In the case of outdoor unit is set lower than indoor unit)
	In branch box/indoor unit section	$h1 + h2 \leq 15$ m
	In each branch unit (h2)	$h2 \leq 15$ m
	In each indoor unit (h3)	$h3 \leq 12$ m
Number of bends	$ c1 + b1 + a1 , c1 + b1 + a2 , c1 + b1 + a3 , c1 + b1 + a4 , c1 + b1 + a5 ,$ $ c1 + c2 + b2 + a6 , c1 + c2 + b2 + a7 , c1 + c2 + b2 + a8 , c1 + c2 + b2 + a9 ,$ $ c1 + c2 + b2 + a10 , c1 + c2 + b3 + a11 , c1 + c2 + b3 + a12 \leq 23$	

*1 Branch box should be placed within the level between the outdoor unit and indoor units.

Select Each Section of Refrigerant Piping

Refer to 7-2-2.

Additional refrigerant charge

Additional refrigerant charge

Refrigerant for the extended piping is not included in the outdoor unit when the unit is shipped from the factory. Therefore, charge each refrigerant piping system with additional refrigerant at the installation site. In addition, in order to carry out service, enter the size and length of each liquid pipe and additional refrigerant charge amounts in the spaces provided on the "Refrigerant amount" plate on the outdoor unit.

* When the unit is stopped, charge the unit with the additional refrigerant through the liquid stop valve after the pipe extensions and indoor units have been vacuumized.

When the unit is operating, add refrigerant to the gas check valve using a safety charger. Do not add liquid refrigerant directly to the check valve.

Calculation of additional refrigerant charge

- Calculate the additional charge using the liquid pipe size and length of the extended piping and total capacity of connected indoor units.
- Calculate the additional refrigerant charge using the procedure shown to the right, and charge with the additional refrigerant.
- For amounts less than 0.1 kg, round up the calculated additional refrigerant charge. (For example, if the calculated charge is 6.01 kg, round up the charge to 6.1 kg.)

<Additional charge>

Calculation of refrigerant charge

Pipe size Liquid pipe ø6.35 (m) × 19.0 (g/m)	+	Pipe size Liquid pipe ø9.52 (m) × 50.0 (g/m)	+	Pipe size Liquid pipe ø12.7 (m) × 92.0 (g/m)	+	Total capacity of connected indoor units	Amount for the indoor units
						- 16.0 kW	2.5 kg
						16.1 kW - 27.0 kW	3.0 kg
						27.1 kW - 31.0 kW	3.5 kg
						31.1 kW - 34.0 kW	4.0 kg
						34.1 kW - 36.5 kW	4.5 kg
						36.6 kW - 39.0 kW	5.0 kg
						39.1 kW - 41.0 kW	5.5 kg
						41.1 kW -	6.1 kg

Included refrigerant amount when shipped from the factory

Model name	Included refrigerant amount
PUMY-P250YBM2	9.3 kg
PUMY-P300YBM2	

<Example>

Outdoor model: PUMY-P250YBM2	b1 + b2 + c1 + c2: ø9.52 30 m	} At the conditions below:
Indoor 1: model 50	a1: ø6.35 15 m	
2: model 50	a2: ø6.35 10 m	
3: model 50	a6: ø6.35 10 m	
4: model 50	a7: ø6.35 10 m	
5: model 50	a8: ø6.35 15 m	
6: model 42	a9: ø6.35 15 m	

The total length of each liquid line is as follows:

$\phi 9.52 : b1 + b2 + c1 + c2 = 30$ m
 $\phi 6.35 : a1 + a2 + a6 + a7 + a8 + a9 = 75$ m

The total capacity of connected indoor unit is as follows:

$50 (5.0\text{kW}) + 50 (5.0\text{kW}) + 50 (5.0\text{kW}) + 50 (5.0\text{kW}) + 50 (5.0\text{kW}) + 42 (4.2\text{kW}) = 292 (29.2\text{kW})$

<Calculation example>

Additional refrigerant charge

$30 \times \frac{50.0}{1000} + 75 \times \frac{19.0}{1000} + 3.5 = 6.5$ kg (rounded up)

Mixed Method
Connection Examples
(Connecting to 1 Branch box)

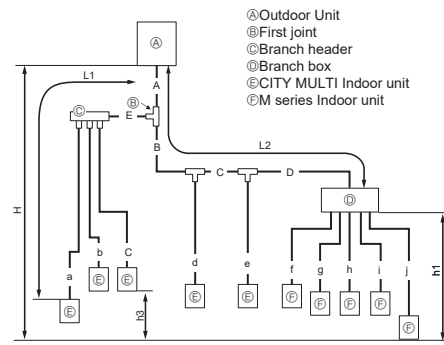

Permissible length (One-way)	Total piping length	$A+B+C+D+E+a+b+c+d+e+f+g+h+i+j \leq 310$ m
	Farthest piping length (L1)	$A+E+a$ or $A+B+C+e \leq 85$ m
	Farthest piping length. Via Branch box	$A+B+C+D+j \leq 80$ m
	Piping length between outdoor unit and branch box	$A+B+C+D \leq 80$ m
	Farthest piping length from the first joint	$B+C+D$ or $B+C+e \leq 30$ m
	Farthest piping length after branch box	$j \leq 25$ m
	Total piping length between branch boxes and indoor units	$f+g+h+i+j \leq 145$ m
Permissible height difference (One-way)	In indoor/outdoor section (H)*1	$H \leq 50$ m (In the case of outdoor unit is set higher than indoor unit) $H \leq 40$ m (In the case of outdoor unit is set lower than indoor unit)
	In branch box/indoor unit section (h1)	$h1 \leq 15$ m
	In each indoor unit (h3)	$h3 \leq 12$ m
Number of bends		≤ 23

*1 Branch box should be placed within the level between the outdoor unit and indoor units.

■ **Selecting the Refrigerant Branch Kit**

Please select branching kit, which is sold separately, from the table below.
(The kit comprises sets for use with liquid pipes and for use with gas pipes.)

Branch joint	Branch header (4 branches)	Branch header (8 branches)
CMY-Y62-G-E	CMY-Y64-G-E	CMY-Y68-G-E

■ **Select Each Section of Refrigerant Piping**

- (1) Section From Outdoor Unit to Branch box or Branch header (A to E) } Each Section of Piping
(2) Sections From Branch box or Branch header to Indoor Unit (a to j)

Select the size from the table to the right.

(1) Refrigerant Piping Diameter In Section From Outdoor Unit to Branch box or Branch header (Outdoor Unit Piping Diameter)

A (mm)		
Model	Liquid pipe	Gas pipe
P250	$\phi 9.52^*$	$\phi 22.2$
P300	$\phi 12.7$	$\phi 22.2$

B to E (mm)			
Total down-stream capacity of indoor units	Model	Liquid pipe	Gas pipe
- 16.0kW	P250	$\phi 9.52^*$	$\phi 15.88$
	P300	$\phi 12.7$	
16.1 kW - 22.4 kW	P250	$\phi 9.52^*$	$\phi 19.05$
	P300	$\phi 12.7$	
22.5 kW -	P250	$\phi 9.52^*$	$\phi 22.2$
	P300	$\phi 12.7$	

* $\phi 12.7$ when connecting the indoor unit for PEFY-P200 or P250.

(2) Refrigerant Piping Diameter In Section From Branch box or Branch header to Indoor Unit (Indoor Unit Piping Diameter)

Indoor unit series	Model number		Liquid pipe	Gas pipe
	kW	cal		
CITY MULTI	- 50	-	$\phi 6.35$	$\phi 12.7$
	63 - 140	-		
	200	-	$\phi 9.52$	$\phi 15.88$
	250	-		
M series	- 35	- 32	$\phi 6.35$	$\phi 9.52$
	50	-		
	-	50	$\phi 9.52$	$\phi 15.88$
	60 -	63 -		
S series	- 35	-	$\phi 6.35$	$\phi 9.52$
	50 - 60	-		
	-	-	$\phi 9.52$	$\phi 15.88$
	71 -	-		

Note:

When connecting the CONNECTION KIT (PAC-LV11M-J) and an M-series indoor unit, refer to the installation manual for the CONNECTION KIT when selecting the pipe size and piping length.

■ **Additional refrigerant charge**

Refer to the same section in the previous page.

Mixed Method
Connection Examples
(Connecting to 2 Branch boxes)

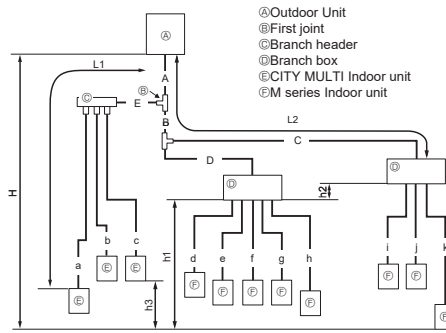

Permissible length (One-way)	Total piping length	$A+B+C+D+E+a+b+c+d+e+f+g+h+i+j+k \leq 310$ m
	Farthest piping length (L1)	$A+E+a \leq 85$ m
	Farthest piping length. Via Branch box	$A+B+C+k \leq 80$ m
	Piping length between outdoor unit and branch boxes	$A+B+C+D \leq 95$ m
	Farthest piping length from the first joint	$B+C$ or $E+a \leq 30$ m
	Farthest piping length after branch box	$k \leq 25$ m
Total piping length between branch boxes and indoor units		$d+e+f+g+h+i+j+k \leq 145$ m
Permissible height difference (One-way)	In indoor/outdoor section (H)*1	$H \leq 50$ m (In the case of outdoor unit is set higher than indoor unit) $H \leq 40$ m (In the case of outdoor unit is set lower than indoor unit)
	In branch box/indoor unit section (h1)	$h1+h2 \leq 15$ m
	In each branch unit (h2)	$h2 \leq 15$ m
	In each indoor unit (h3)	$h3 \leq 12$ m
Number of bends		≤ 23

*1 Branch box should be placed within the level between the outdoor unit and indoor units.

■ **Selecting the Refrigerant Branch Kit**

Please select branching kit, which is sold separately, from the table below.
(The kit comprises sets for use with liquid pipes and for use with gas pipes.)

Branch joint	Branch header (4 branches)	Branch header (8 branches)
CMY-Y62-G-E	CMY-Y64-G-E	CMY-Y68-G-E

■ **Select Each Section of Refrigerant Piping**

- (1) Section From Outdoor Unit to Branch box or Branch header (A to E)
(2) Sections From Branch box or Branch header to Indoor Unit (a to k)
- Each Section of Piping

Select the size from the table to the right.

(1) Refrigerant Piping Diameter In Section From Outdoor Unit to Branch box or Branch header (Outdoor Unit Piping Diameter)

A	(mm)		
	Model	Liquid pipe	Gas pipe
	P250	$\phi 9.52^*$	$\phi 22.2$
P300	$\phi 12.7$	$\phi 22.2$	

B to E	(mm)			
	Total down-stream capacity of indoor units	Model	Liquid pipe	Gas pipe
	– 16.0kW	P250	$\phi 9.52^*$	$\phi 15.88$
		P300	$\phi 12.7$	
	16.1 kW – 22.4 kW	P250	$\phi 9.52^*$	$\phi 19.05$
		P300	$\phi 12.7$	
22.5 kW –	P250	$\phi 9.52^*$	$\phi 22.2$	
	P300	$\phi 12.7$		

* $\phi 12.7$ when connecting the indoor unit for PEFY-P200 or P250.

(2) Refrigerant Piping Diameter In Section From Branch box or Branch header to Indoor Unit (Indoor Unit Piping Diameter)

Indoor unit series	Model number		Liquid pipe	Gas pipe
	kW	cal		
CITY MULTI	– 50	–	$\phi 6.35$	$\phi 12.7$
	63 – 140	–	$\phi 9.52$	$\phi 15.88$
	200	–		$\phi 19.05$
	250	–		$\phi 22.2$
M series	– 35	– 32	$\phi 6.35$	$\phi 9.52$
	50	–		$\phi 12.7$
	–	50		$\phi 15.88$
	60 –	63 –		$\phi 9.52$
S series	– 35	–	$\phi 6.35$	$\phi 9.52$
	50 – 60	–		$\phi 12.7$
	–	–		$\phi 15.88$

Note:

When connecting the CONNECTION KIT (PAC-LV11M-J) and an M-series indoor unit, refer to the installation manual for the CONNECTION KIT when selecting the pipe size and piping length.

■ **Additional refrigerant charge**

Refer to the same section in the previous page.

Mixed Method
Connection Examples
(Connecting to 3 Branch boxes)

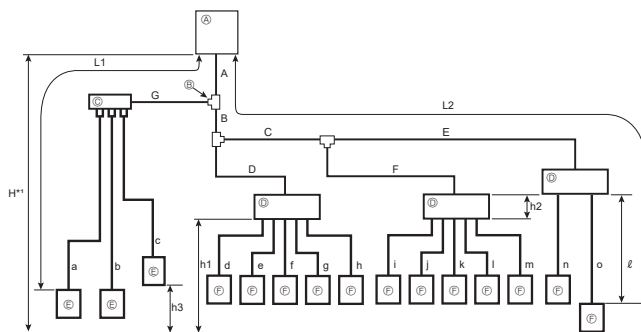

- Ⓐ Outdoor unit
- Ⓑ First joint
- Ⓒ Branch header
- Ⓓ Branch box
- Ⓔ CITY MULTI indoor unit
- Ⓕ M series indoor unit

Permissible length (One-way)	Total piping length	$A + G + B + C + D + F + E + a + b + c + d + e + f + g + h + i + j + k + l + m + n + o \leq 310$ m
	Farthest piping length (L1)	$A + G + a \leq 85$ m
	Farthest piping length via branch box (L2)	$A + B + C + E + o \leq 80$ m
	Piping length between outdoor unit and branch boxes	$A + B + C + D + F + E \leq 95$ m
	Farthest piping length from the first joint	$B + C + E$ or $G + a \leq 30$ m
	Farthest piping length after branch box (ℓ)	$o \leq 25$ m
Permissible height difference (One-way)	Total piping length between branch boxes and indoor units	$d + e + f + g + h + i + j + k + l + m + n + o \leq 145$ m
	In indoor/outdoor section (H)*1	$H \leq 50$ m (In the case of outdoor unit is set higher than indoor unit) $H \leq 40$ m (In the case of outdoor unit is set lower than indoor unit)
	In branch box/indoor unit section	$h1 + h2 \leq 15$ m
	In each branch unit (h2)	$h2 \leq 15$ m
Number of bends	In each indoor unit (h3)	$h3 \leq 12$ m
		≤ 23

*1 Branch box should be placed within the level between the outdoor unit and indoor units.

■ **Selecting the Refrigerant Branch Kit**

Please select branching kit, which is sold separately, from the table below.
(The kit comprises sets for use with liquid pipes and for use with gas pipes.)

Branch joint	Branch header (4 branches)	Branch header (8 branches)
CMY-Y62-G-E	CMY-Y64-G-E	CMY-Y68-G-E

■ **Select Each Section of Refrigerant Piping**

- (1) Section From Outdoor Unit to Branch box or Branch header (A to G)
 - (2) Sections From Branch box or Branch header to Indoor Unit (a to o)
- } Each Section of Piping

Select the size from the table to the right.

(1) Refrigerant Piping Diameter In Section From Outdoor Unit to Branch box or Branch header (Outdoor Unit Piping Diameter)

Model	A (mm)	
	Liquid pipe	Gas pipe
P250	ø9.52*	ø22.2
P300	ø12.7	ø22.2

Total down-stream capacity of indoor units	B to G (mm)		
	Model	Liquid pipe	Gas pipe
– 16.0kW	P250	ø9.52*	ø15.88
	P300	ø12.7	
16.1 kW – 22.4 kW	P250	ø9.52*	ø19.05
	P300	ø12.7	
22.5 kW –	P250	ø9.52*	ø22.2
	P300	ø12.7	

* ø12.7 when connecting the indoor unit for PEFY-P200 or P250.

(2) Refrigerant Piping Diameter In Section From Branch box or Branch header to Indoor Unit (Indoor Unit Piping Diameter)

Indoor unit series	Model number		Liquid pipe	Gas pipe
	kW	cal		
CITY MULTI	– 50	–	ø6.35	ø12.7
	63 – 140	–		
	200	–	ø9.52	ø15.88
	250	–		ø19.05
M series	– 35	– 32	ø6.35	ø9.52
	50	–		ø12.7
	–	50	ø9.52	ø15.88
	60 –	63 –		ø15.88
S series	– 35	–	ø6.35	ø9.52
	50 – 60	–		ø12.7
	–	–	ø9.52	ø15.88
	71 –	–		ø15.88

Note:
When connecting the CONNECTION KIT (PAC-LV11M-J) and an M-series indoor unit, refer to the installation manual for the CONNECTION KIT when selecting the pipe size and piping length.

■ **Additional refrigerant charge**

Refer to the same section in the previous page.

10-2. PRECAUTIONS AGAINST REFRIGERANT LEAKAGE

10-2-1. Introduction

R410A refrigerant of this air conditioner is non-toxic and non-flammable but leaking of large amount from an indoor unit into the room where the unit is installed may be deleterious. To prevent possible injury, the rooms should be large enough to keep the R410A concentration specified by ISO 5149-1 as follows.

Maximum concentration
 Maximum refrigerant concentration of R410A of a room is 0.44kg/m³ accordance with ISO 5149-1.
 To facilitate calculation, the maximum concentration is expressed in units of kg/m³ (kg of R410A per m³)
Maximum concentration of R410A: 0.44 kg/m³
 (ISO 5149-1)

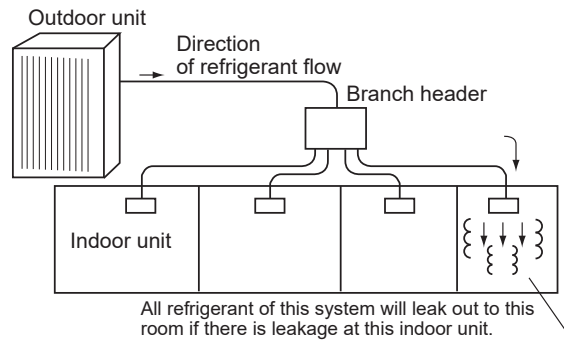

10-2-2. Confirming procedure of R410A concentration

Follow (1) to (3) to confirm the R410A concentration and take appropriate treatment, if necessary.

(1) Calculate total refrigerant amount by each refrigerant system. Total refrigerant amount is precharged refrigerant at ex-factory plus additional charged amount at field installation.

Note:
 When the air conditioning system consists of several independent refrigerant system, figure out the total refrigerant amount by each independent refrigerant system.

(2) Calculate room volumes (m³) and find the room with the smallest volume

The part with represents the room with the smallest volume.

(a) Situation in which there are no partitions

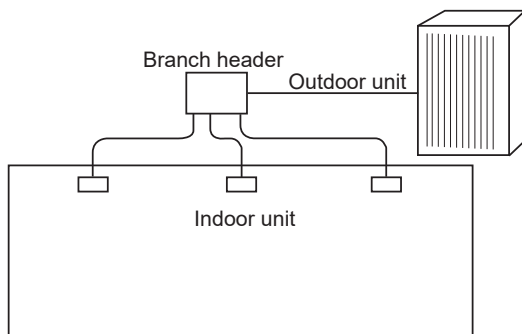

(b) There are partitions, but there are openings that allow the effective mixing of air.

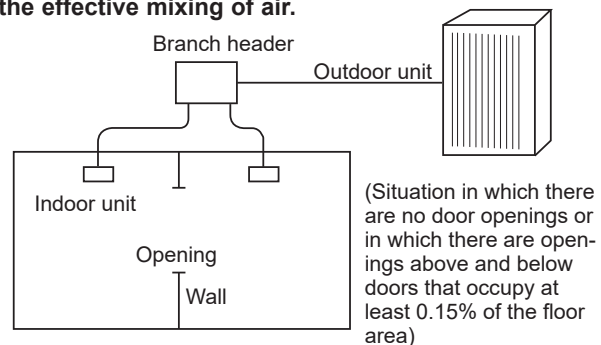

(c) If the smallest room has mechanical ventilation apparatus that is linked to a household gas detection and alarm device, the calculations should be performed for the second smallest room.

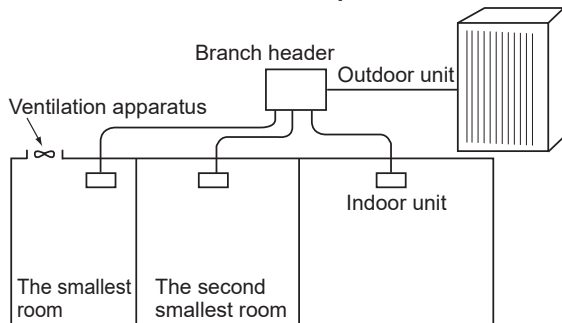

(3) Use the results of calculations (1) and (2) to calculate the refrigerant concentration:

$$\frac{\text{Total refrigerant in the refrigerating unit (kg)}}{\text{The smallest room in which an indoor unit has been installed (m}^3\text{)}} \leq \text{Maximum concentration(kg/m}^3\text{)*}$$

*Maximum concentration of R410A:0.44kg/m³

If the calculation results do not exceed the maximum concentration, perform the same calculation for larger rooms until it has been determined that nowhere exceeds the maximum concentration.

11-1. OUTDOOR UNIT

—————> : Indicates the visible parts in the photos/figures.
 - - - - -> : Indicates the invisible parts in the photos/figures.

Note: Turn OFF the power supply before disassembly.

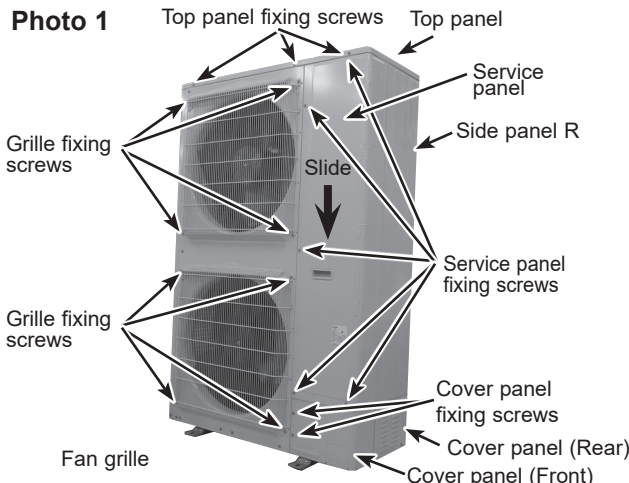
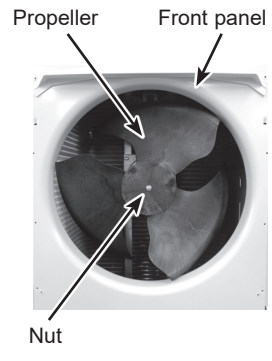
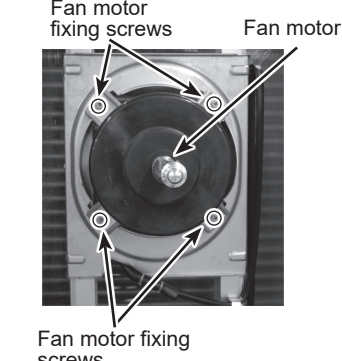
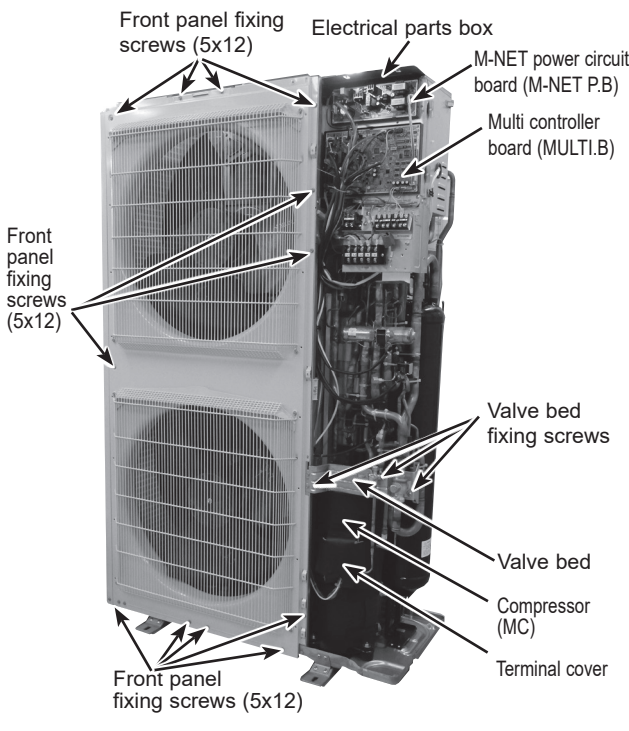
OPERATING PROCEDURE	PHOTOS/FIGURES
<p>1. Removing the panels on the right side of the unit</p> <ol style="list-style-type: none"> (1) Remove service panel fixing screws (5 × 12) and slide the hook on the right downward to remove the service panel. (2) Remove screws (5 × 12) of the top panel and remove it. (3) Remove front cover panel fixing screws (5 × 12) and remove the front cover panel. (4) Remove back cover panel fixing screws (5 × 12) and remove the back cover panel. (5) Remove side panel R fixing screws (5 × 12) in the rear of the unit and then remove the side panel R. 	<p>Photo 1</p> 
<p>2. Removing the fan motor (MF1, MF2)</p> <ol style="list-style-type: none"> (1) Remove the service panel. (See Photo 1) (2) Remove the top panel. (See Photo 1) (3) Remove fan grille fixing screws (5 × 12) to detach the fan grille. (See Photo 1) (4) Remove a nut (for right handed screw of M6) to detach the propeller. (See Photo 2.) (5) Disconnect the connectors, CNF1 and CNF2 on multi controller board in electrical parts box. (6) Remove fan motor fixing screws (5 × 20) to detach the fan motor. (See Photo 3) <p>Note: MF1 (Upper) ... The color of its connector is white. MF2 (Lower) ... The color of its connector is blue.</p>	<p>Photo 2</p>  <p>Photo 3</p> 
<p>3. Removing the electrical parts box</p> <ol style="list-style-type: none"> (1) Remove the service panel. (See Photo 1) (2) Remove the top panel. (See Photo 1) (3) Disconnect the connecting wire from terminal block. (See Photo 5) (4) Remove all the following connectors from multi controller board; <Diagram symbol in the connector housing> <ul style="list-style-type: none"> • Fan motor (CNF1, CNF2) • Thermistor <HIC pipe> (TH2) • Thermistor <Outdoor liquid pipe> (TH3) • Thermistor <Compressor> (TH4) • Thermistor <Suction pipe/Ambient, Outdoor> (TH6/7) • High pressure switch (63H) • High pressure sensor (63HS) • Low pressure sensor (63LS) • 4-way valve (21S4) • Bypass valve (SV1) • Oil return valve (SV3) • Linear Expansion valve (LEV-A, LEV-B) <p>Pull out the disconnected wire from the electrical parts box.</p> <ol style="list-style-type: none"> (5) Remove the cover panel front. (See Photo 1) (6) Remove the cover panel rear. (See Photo 1) (7) Remove the side panel R. (See Photo 1) (8) Remove the terminal cover and disconnect the compressor lead wire. 	<p>Photo 4</p> 

From the previous page.

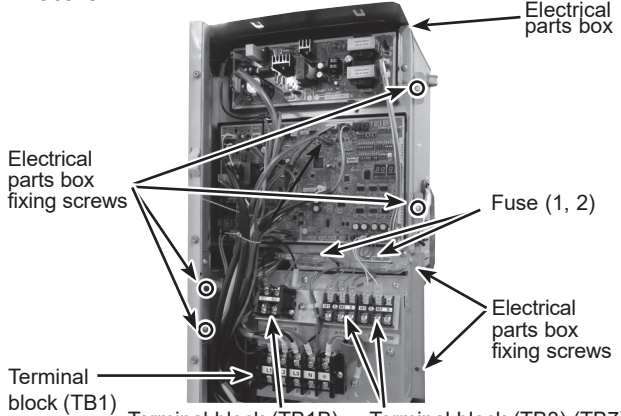
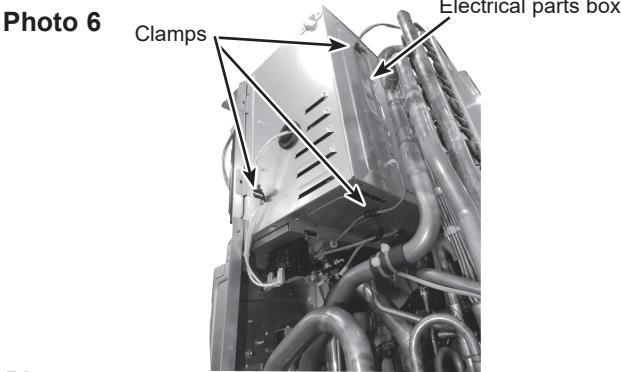
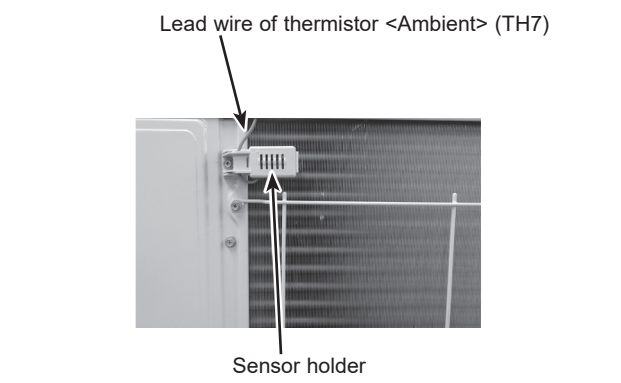
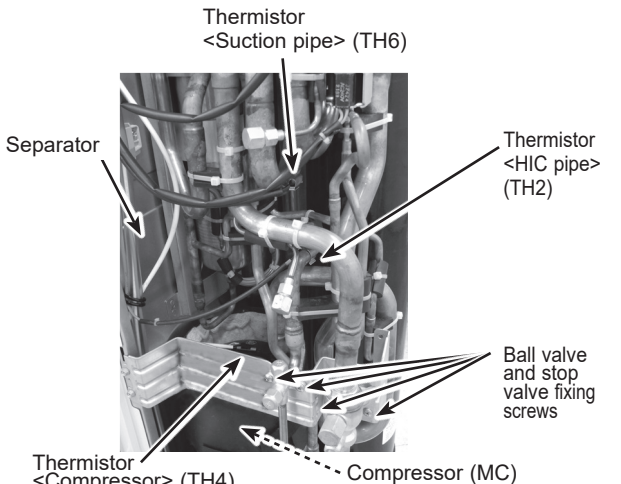
OPERATING PROCEDURE	PHOTOS/FIGURES
<p>(9) Remove electrical parts box fixing screws (5 × 12) and detach the electrical parts box by pulling it upward.</p>	<p>Photo 5</p> 
<p>4. Removing the thermistors <Suction pipe> (TH6) and <Ambient> (TH7)</p> <ol style="list-style-type: none"> (1) Remove the service panel. (See Photo 1) (2) Remove the top panel. (See Photo 1) (3) Disconnect the connectors, TH6 and TH7 (red), on the multi controller board in the electrical parts box. (4) Remove the cover panel front. (See Photo 1) (5) Remove the cover panel rear. (See Photo 1) (6) Remove the side panel R. (See Photo 1) (7) Remove the wire of TH7 from the clamps and clips on the bottom and the side of the electrical parts box. (See Photo 6) (8) Pull out the thermistor <Ambient> (TH7) from the sensor holder. (See Photo 7) (9) Pull out the thermistor <Suction pipe> (TH6) from the sensor holder. (See Photo 8) <p>Note: When replacing thermistor <Suction pipe> (TH6) or <Ambient> (TH7), replace them together since they are combined together.</p>	<p>Photo 6</p>  <p>Photo 7</p> 
<p>5. Removing the thermistor <Compressor> (TH4) and thermistor <HIC pipe> (TH2)</p> <ol style="list-style-type: none"> (1) Remove the service panel. (See Photo 1) (2) Disconnect the connectors, TH4 (white) and TH2 (black) on the multi controller board in the electrical parts box. (3) Loosen the clamp or band for the lead wire of the electrical parts box and the separator. (4) Pull out the thermistor <Compressor> (TH4) from the sensor holder. (See Photo 8) 	<p>Photo 8</p> 

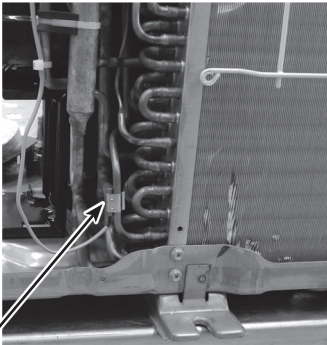
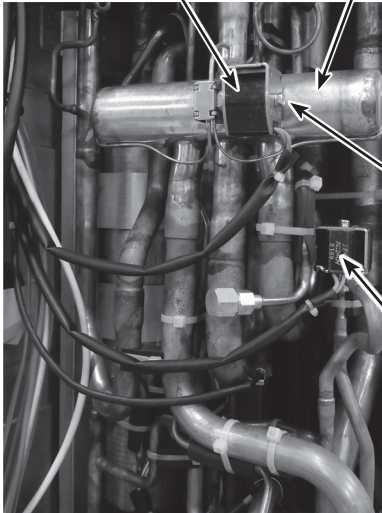

OPERATING PROCEDURE	PHOTOS/FIGURES
<p>6. Removing the thermistor <Outdoor liquid pipe> (TH3)</p> <ol style="list-style-type: none">(1) Remove the service panel. (See Photo 1)(2) Remove the top panel. (See Photo 1)(3) Remove the cover panel front. (See Photo 1)(4) Remove the cover panel rear. (See Photo 1)(5) Remove the side panel R. (See Photo 1)(6) Disconnect the connector, TH3 (white), on the Multi controller board in the electrical parts box.(7) Loosen the clamp or band for the lead wire of the electrical parts box and the separator.(8) Pull out the thermistor <Outdoor liquid pipe> (TH3) from the sensor holder. (See Photo 9) <p>Note: Attach the band to the same position when loosening it.</p>	<p>Photo 9</p>  <p>Thermistor <Outdoor liquid pipe> (TH3)</p>
<p>7. Removing the 4-way valve coil (21S4)</p> <ol style="list-style-type: none">(1) Remove the service panel. (See Photo 1) <p>[Removing the 4-way valve coil]</p> <ol style="list-style-type: none">(2) Remove 4-way valve coil fixing screw (M5 × 7).(3) Remove the 4-way valve coil by sliding the coil toward you.(4) Loosen the clamp or band for the lead wire of the electrical parts box and the separator.(5) Disconnect the connector 21S4 (green) on the multi controller board in the electrical parts box.	<p>Photo 10</p>  <p>4-way valve coil (21S4)</p> <p>4-way valve</p> <p>4-way valve coil fixing screw</p> <p>Bypass valve coil (SV3)</p>
<p>8. Removing the 4-way valve</p> <ol style="list-style-type: none">(1) Remove the service panel. (See Photo 1)(2) Remove the top panel. (See Photo 1)(3) Remove the cover panel front. (See Photo 1)(4) Remove the cover panel rear. (See Photo 1)(5) Remove the side panel R. (See Photo 1)(6) Remove the electrical parts box. (See Photo 5)(7) Remove ball valve and stop valve fixing screws (5 × 16) then valve bed fixing screws (5 × 12) and remove the valve bed. (See Photo 8)(8) Remove the 4-way valve coil. (See Photo 10)(9) Recover refrigerant.(10) Remove the welded part of 4-way valve. <p>Note 1: Recover refrigerant without spreading it in the air.</p> <p>Note 2: When installing the 4-way valve, cover it with a wet cloth to prevent it from heating (120°C or more), then braze the pipes so that the inside of pipes are not oxidized.</p>	

OPERATING PROCEDURE

9. Removing bypass valve coil (SV1 and SV3) and bypass valve

- (1) Remove the service panel. (See Photo 1)
- (2) Remove the top panel. (See Photo 1)
- (3) Remove the cover panel front. (See Photo 1)
- (4) Remove the cover panel rear. (See Photo 1)
- (5) Remove the side panel R. (See Photo 1)
- (6) Remove the bypass valve coil fixing screw (M4 × 6).
- (7) Remove the bypass valve coil by sliding the coil upward.
- (8) Disconnect the connector SV1 (gray) and SV3 (black) on the multi controller circuit board in the electrical parts box. (See Photo 10 and 11)
- (9) Remove the electrical parts box to remove SV1. (See Photo 5)
- (10) Recover refrigerant.
- (11) Remove the welded part of bypass valve.

Refer to the notes below.

10. Removing the high pressure switch (63H), high pressure sensor (63HS), and low pressure sensor (63LS)

- (1) Remove the service panel. (See Photo 1)
- (2) Remove the top panel. (See Photo 1)
- (3) Remove the cover panel front. (See Photo 1)
- (4) Remove the cover panel rear. (See Photo 1)
- (5) Remove the side panel R. (See Photo 1)
- (6) Pull out the lead wire of high pressure switch or disconnect the connector 63HS (white) and connector 63LS (blue) from the multi controller circuit board in the electrical parts box.
- (7) Remove the electrical parts box. (See Photo 5)
- (8) Recover refrigerant.
- (9) Remove the welded part of high pressure switch, high pressure sensor and low pressure sensor.

Refer to the notes to the right.

11. Removing linear expansion valve (LEV-A, LEV-B)

- (1) Remove the service panel. (See Photo 1)
- (2) Remove the top panel. (See Photo 1)
- (3) Remove the cover panel front. (See Photo 1)
- (4) Remove the cover panel rear. (See Photo 1)
- (5) Remove the side panel R. (See Photo 1)
- (6) Remove the electrical parts box. (See Photo 5)
- (7) Remove the linear expansion valve coil. (See Photo 11)
- (8) Recover refrigerant.
- (9) Remove the welded part of linear expansion valve.

12. Removing the reactor (DCL, DCL2)

- (1) Remove the service panel. (See Photo 1)
- (2) Remove the top panel. (See Photo 1)
- (3) Remove the cover panel front. (See Photo 1)
- (4) Remove the cover panel rear. (See Photo 1)
- (5) Remove the side panel R. (See Photo 1)
- (6) Remove the electrical parts box. (See Photo 5)
- (7) Disconnect the lead wires from the reactor. (See Photo 12)
- (8) Disconnect the terminals of reactor on the bottom plate of the electrical parts box. (See Photo 12)
- (9) Remove screws ① of the reactor (DCL2) and screws ② of the reactor (DCL) on the bottom plate of the electrical parts box. (See Photo 12)
- (10) Remove the reactor.

PHOTOS/FIGURES

Photo 11

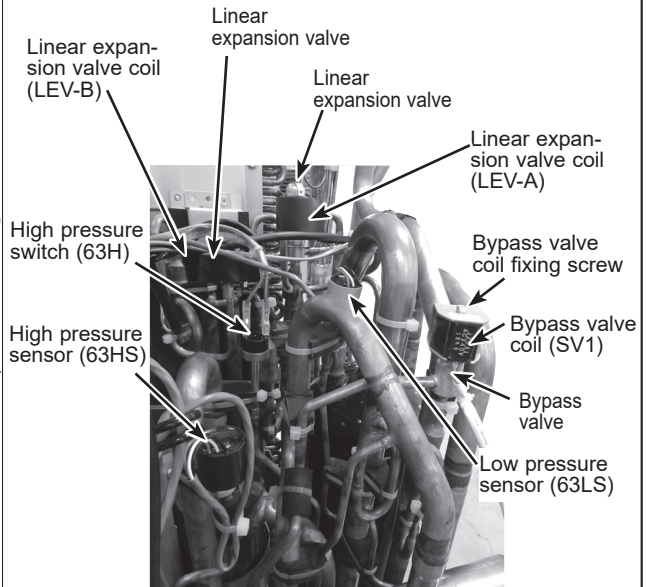

Notes:

1. Recover refrigerant without spreading it in the air.
2. When installing the following parts, cover it with a wet cloth to prevent it from heating as the temperature below, then braze the pipes so that the inside of pipes are not oxidized;
 - Bypass valve (procedure 9), 120°C or more
 - High pressure switch and high pressure sensor (procedure 10), 100°C or more
 - Low pressure sensor (procedure 10), 100°C or more

Photo 12

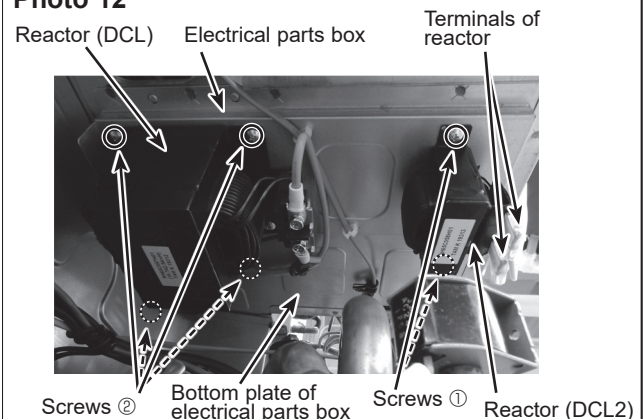

OPERATING PROCEDURE

13. Removing the compressor (MC)

- (1) Remove the service panel. (See Photo 1)
- (2) Remove the top panel. (See Photo 1)
- (3) Remove the cover panel front. (See Photo 1)
- (4) Remove the cover panel rear. (See Photo 1)
- (5) Remove ball valve and stop valve fixing screws (5 × 16) then valve bed fixing screws (5 × 12) and remove the valve bed. (See Photo 13)
- (6) Remove the comp felt covering the compressor, remove the thermistor <Compressor> (TH4), remove the compressor protector (TRS) and the lead wires. (See Photo 8, 13 and 16)
- (7) Recover refrigerant.
- (8) Remove the 3 compressor fixing nuts for motor using spanner or adjustable wrench.
- (9) Remove the welded pipe of motor for compressor inlet and outlet and then remove the compressor.

Note: Recover refrigerant without spreading it in the air.

PHOTOS/FIGURES

Photo 13

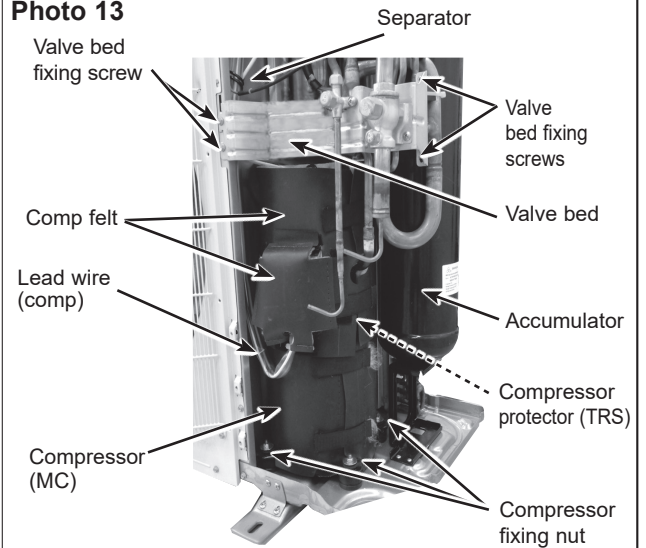
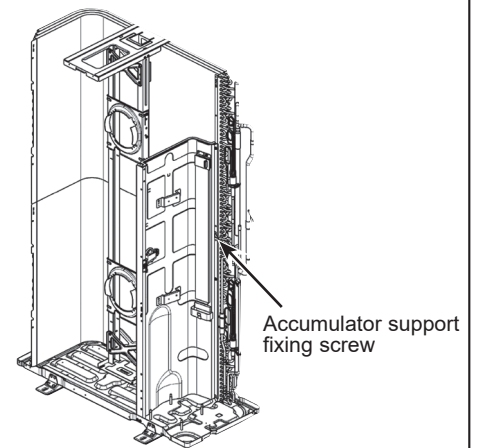

Figure 1



14. Removing the accumulator

- (1) Remove the service panel. (See Photo 1)
- (2) Remove the top panel. (See Photo 1)
- (3) Remove the cover panel front. (See Photo 1)
- (4) Remove the cover panel rear. (See Photo 1)
- (5) Remove the side panel R. (See Photo 1)
- (6) Remove the electrical parts box. (See Photo 5)
- (7) Recover refrigerant.
- (8) Remove 4 welded pipes of accumulator inlets and outlets. (See Photo 14)
- (9) Remove accumulator leg fixing screws (2 [4 × 10] screws and 2 [5 × 12] screws). (See Photo 15 and Figure 1)

Note: Recover refrigerant without spreading it in the air.

Photo 14

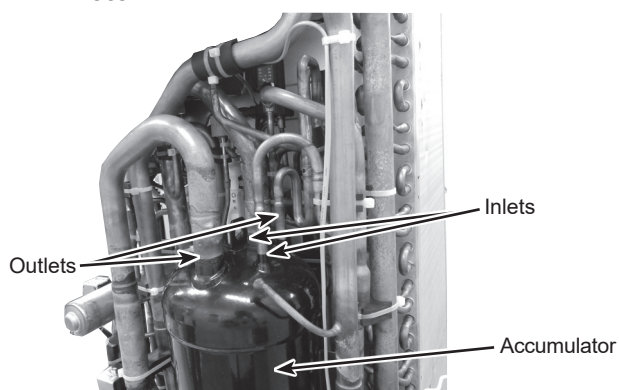
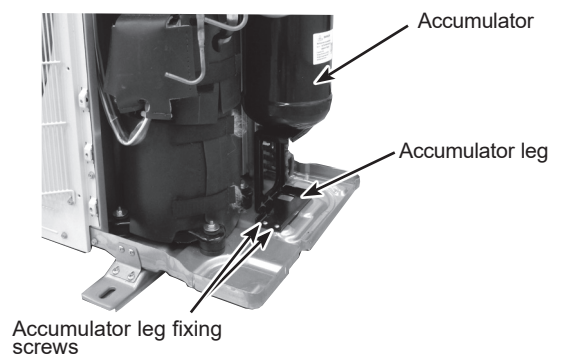

Photo 15



OPERATING PROCEDURE

15. Removing the Compressor protector (TRS)

- (1) Remove the service panel. (See Photo 1)
- (2) Remove the top panel. (See Photo 1)
- (3) Remove the cover panel front. (See Photo 1)
- (4) Remove the cover panel rear. (See Photo 1)
- (5) Remove the side panel R. (See Photo 1)
- (6) Pull out the lead wire of high pressure switch and disconnect the connector, 63H (yellow) from the multi controller board in the electrical parts box. (See Photo 11)
- (7) Remove the comp felt covering the compressor. (See Photo 13)
- (8) Loosen the clamp or band for the lead wire of the electrical parts box and separator.
- (9) pull out the Compressor protector (TRS) from the holder. (See Photo 16)

PHOTOS/FIGURES

Photo 16



Compressor protector (TRS)

Holder

12-1. REMOTE CONTROLLER FUNCTIONS

<PAR-4xMAA>

("x" represents 1 or later)

Controller interface

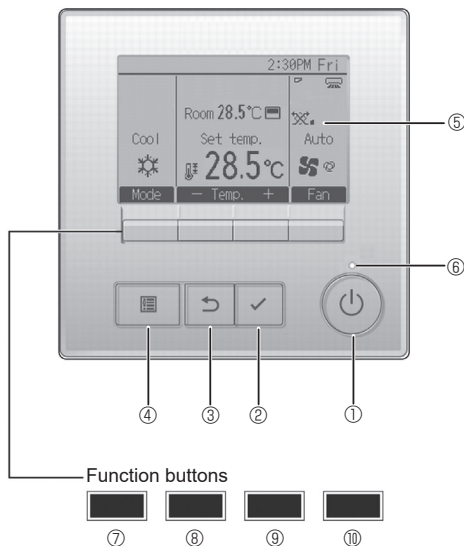

① [ON/OFF] button

Press to turn ON/OFF the indoor unit.

② [SELECT] button

Press to save the setting.

③ [RETURN] button

Press to return to the previous screen.

④ [MENU] button

Press to bring up the Main menu.

⑤ Backlit LCD

Operation settings will appear.

When the backlight is off, pressing any button turns the backlight on and it will stay lit for a certain period of time depending on the screen.

When the backlight is off, pressing any button turns the backlight on and does not perform its function. (except for the [ON/OFF] button)

The functions of the function buttons change depending on the screen.

Refer to the button function guide that appears at the bottom of the LCD for the functions they serve on a given screen.

When the system is centrally controlled, the button function guide that corresponds to the locked button will not appear.

Main display

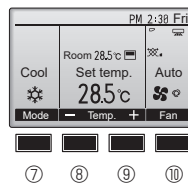

Main menu

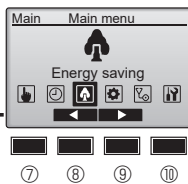

Menu screen

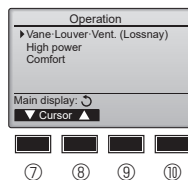

Function guide

⑥ ON/OFF lamp

This lamp lights up in green while the unit is in operation. It blinks while the remote controller is starting up or when there is an error.

⑦ Function button [F1]

Main display: Press to change the operation mode.

Menu screen: The button function varies with the screen.

⑧ Function button [F2]

Main display: Press to decrease temperature.

Main menu: Press to move the cursor left.

Menu screen: The button function varies with the screen.

⑨ Function button [F3]

Main display: Press to increase temperature.

Main menu: Press to move the cursor right.

Menu screen: The button function varies with the screen.

⑩ Function button [F4]

Main display: Press to change the fan speed.

Menu screen: The button function varies with the screen.

Display

The main display can be displayed in two different modes: "Full" and "Basic". The initial setting is "Full". To switch to the "Basic" mode, change the setting on the Main display setting. (Refer to operation manual included with remote controller.)

<Full mode>

* All icons are displayed for explanation.

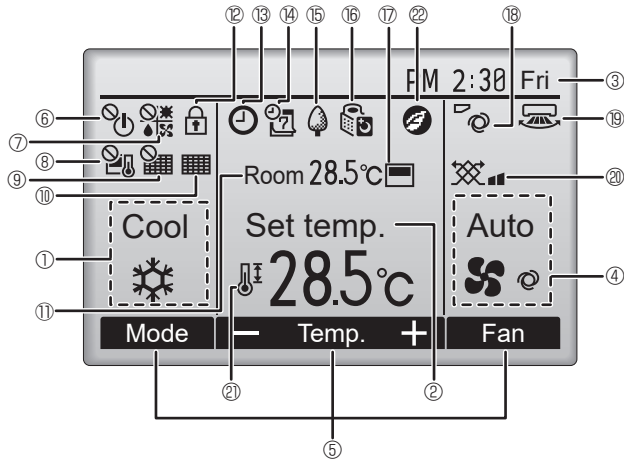

<Basic mode>

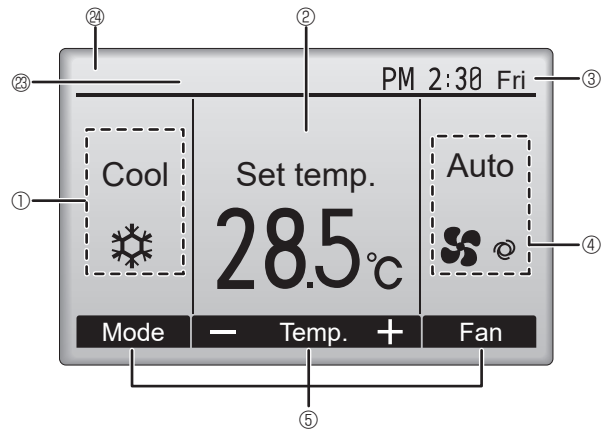

① Operation mode

② Preset temperature

③ Clock

④ Fan speed

⑤ Button function guide

Functions of the corresponding buttons appear here.



Appears when the ON/OFF operation is centrally controlled.



Appears when the operation mode is centrally controlled.



Appears when the preset temperature is centrally controlled.



Appears when the filter reset function is centrally controlled.



Indicates when filter needs maintenance.

⑪ Room temperature



Appears when the buttons are locked.



Appears when the On/Off timer, Night setback, or Auto-off timer function is enabled.

appears when the timer is disabled by the centralized control system.



Appears when the Weekly timer is enabled.



Appears while the units are operated in the energy saving mode. (Will not appear on some models of indoor units)



Appears while the outdoor units are operated in the silent mode.



Appears when the built-in thermistor on the remote controller is activated to monitor the room temperature (⑪).

appears when the thermistor on the indoor unit is activated to monitor the room temperature.



Indicates the vane setting.



Indicates the louver setting.



Indicates the ventilation setting.



Appears when the preset temperature range is restricted.



Appears when an energy saving operation is performed using a "3D i-See sensor" function.

②③ Centrally controlled

Appears for a certain period of time when a centrally-controlled item is operated.

②④ Preliminary error display

A check code appears during the preliminary error.

Most settings (except ON/OFF, mode, fan speed, temperature) can be made from the Main menu.

Menu structure

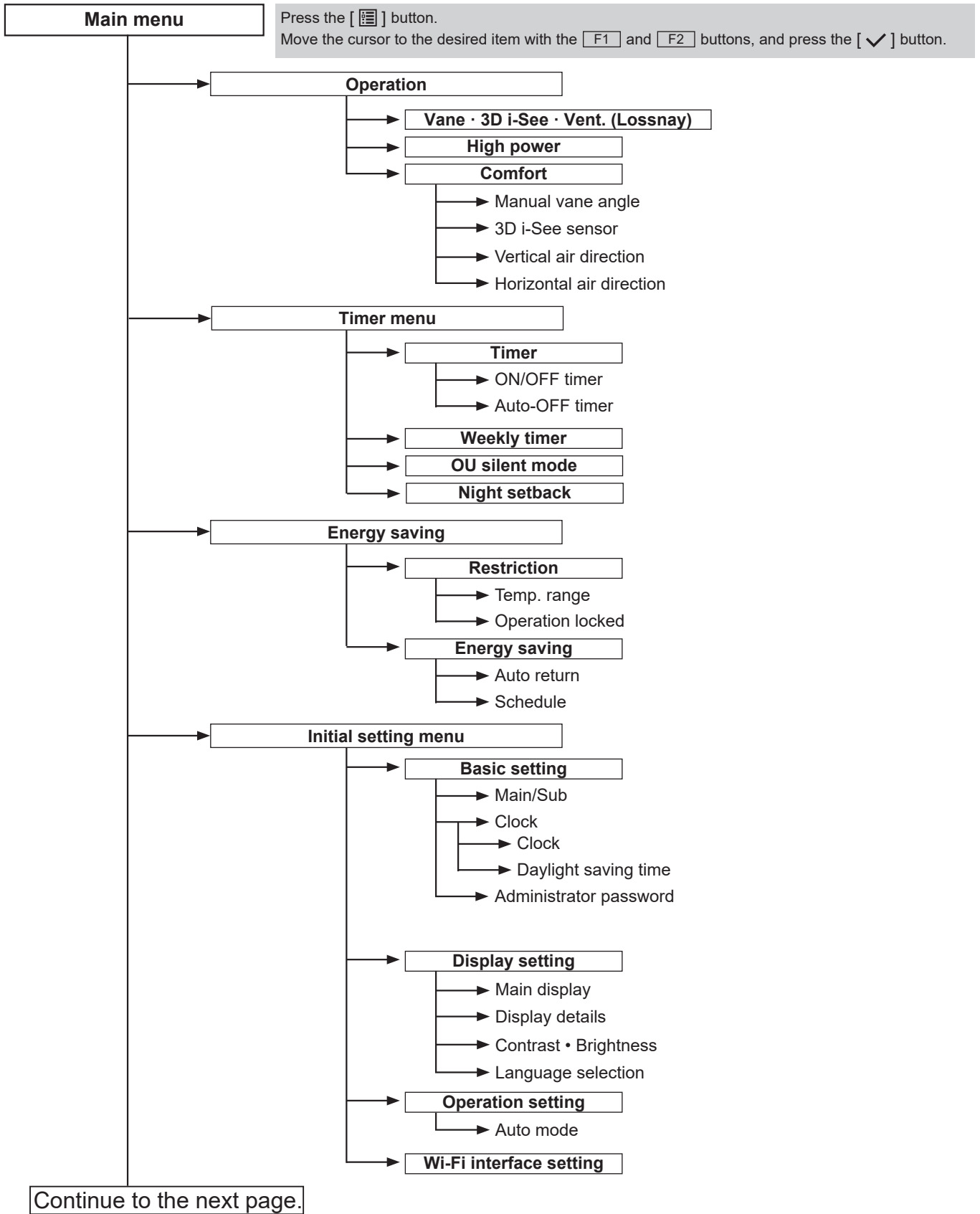

Not all functions are available on all models of indoor units.

Continue from the previous page.

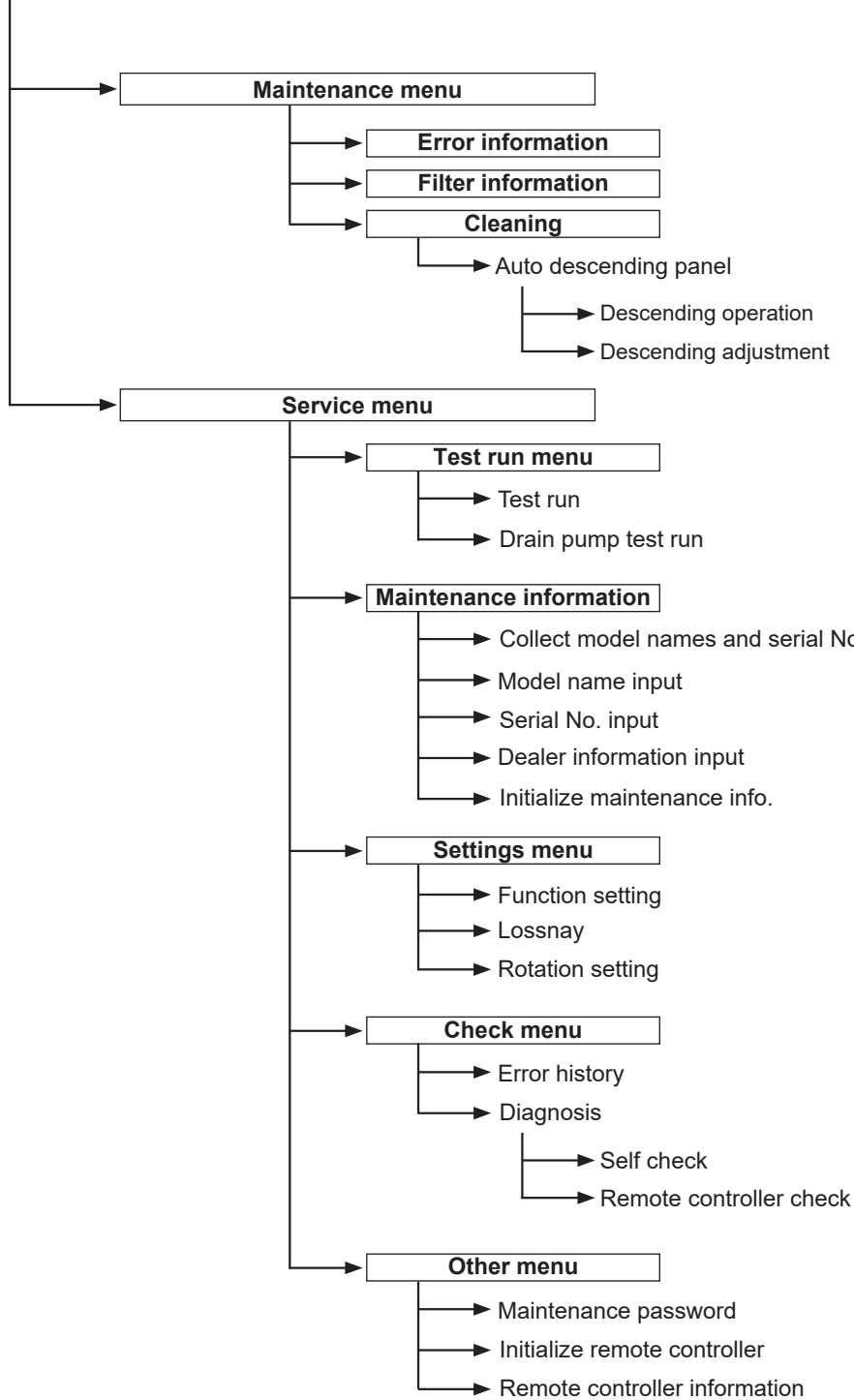

Not all functions are available on all models of indoor units.

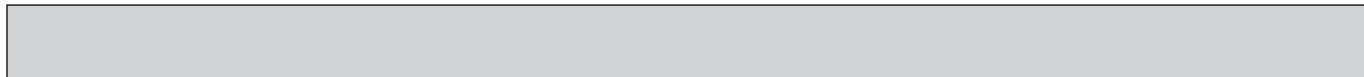

Main menu list

Main menu	Setting and display items		Setting details
Operation	Vane · 3D i-See · Vent. (Vane.Vent. (Lossnay))		Vane: Use to set the vertical air direction. Louver: Use to set the horizontal air direction. 3D i-See sensor: This setting is available only for the air conditioners that support easy setting function of motion sensing air direction. Vent: Use to set the amount of ventilation.
	High power ^{*3}		Use to reach the comfortable room temperature quickly. • Units can be operated in the High-power mode for up to 30 minutes.
	Comfort	Manual vane angle	Vertical air direction • Sets the vertical airflow direction (vane) of each unit. Horizontal air direction • Sets the horizontal airflow direction (vane) of each unit.
		3D i-See sensor	Use to set the following functions for 3D i-See sensor. • Air distribution • Energy saving option • Seasonal airflow
Timer	Timer	ON/OFF timer ^{*1}	Use to set the operation ON/OFF times. • Time can be set in 5-minute increments.
		Auto-OFF timer	Use to set the Auto-OFF time. • Time can be set to a value from 30 to 240 in 10-minute increments.
	Weekly timer ^{*1, *2}		Use to set the weekly operation ON/OFF times. • Up to 8 operation patterns can be set for each day. (Not valid when the ON/OFF timer is enabled.)
	OU silent mode ^{*1, *3}		Use to set the time periods in which priority is given to quiet operation of outdoor units over temperature control. Set the Start/Stop times for each day of the week. • Select the desired silent level from "Normal," "Middle," and "Quiet."
	Night setback ^{*1}		Use to make Night setback settings. • Select "Yes" to enable the setting, and "No" to disable the setting. The temperature range and the start/stop times can be set.
Energy saving	Restriction	Temp. range ^{*2}	Use to restrict the preset temperature range. • Different temperature ranges can be set for different operation modes.
		Operation lock	Use to lock selected functions. • The locked functions cannot be operated.
	Energy saving	Auto return ^{*2}	Use to get the units to operate at the preset temperature after performing energy saving operation for a specified time period. • Time can be set to a value from 30 and 120 in 10-minute increments. (This function will not be valid when the preset temperature ranges are restricted.)
		Schedule ^{*1, *3}	Set the start/stop times to operate the units in the energy saving mode for each day of the week, and set the energy saving rate. • Up to 4 energy saving operation patterns can be set for each day. • Time can be set in 5-minute increments. • Energy saving rate can be set to a value from 0% or 50 to 90% in 10% increments.
	Energy data (for unit time, month, and day)		Displays the amount of power consumption during operation. • Unit time data: Data for the last one-month period can be displayed in 30-minute units. • Monthly/daily data: Data for the last 14-month period are displayed in day-and-month-units. * Data can be deleted. * Data are obtained based on the power consumption estimated from the operating state.

^{*1} Clock setting is required.

^{*2} 1°C increments.

^{*3} This function is available only when certain outdoor units are connected.



Main menu	Setting and display items		Setting details
Initial setting	Basic setting	Main/Sub	When connecting 2 remote controllers, one of them needs to be designated as a sub controller.
		Clock	Use to set the current time.
		Daylight saving time	Set the daylight saving time.
		Administrator password	The administrator password is required to make the settings for the following items. • Timer setting • Energy saving setting • Weekly timer setting • Restriction setting • Outdoor unit silent mode setting • Night set back
	Display setting	Main display	Use to switch between "Full" and "Basic" modes for the Main display, and use to change the background colors of the display to black.
		Display details	Make the settings for the remote controller related items as necessary. Clock: The initial settings are "Yes" and "24h" format. Temperature: Set either Celsius (°C) or Fahrenheit (°F). Room temp.: Set Show or Hide. Auto mode: Set Auto mode display or Only Auto display.
		Contrast • Brightness	Use to adjust screen contrast and brightness.
		Language selection	Use to select the desired language.
Operation setting	Auto mode	Whether or not to use Auto mode can be selected by using the button. This setting is valid only when indoor units with Auto mode function are connected.	
Maintenance	Error information		Use to check error information when an error occurs. • Check code, error source, refrigerant address, model name, manufacturing number, contact information (dealer's phone number) can be displayed. (The model name, manufacturing number, and contact information need to be registered in advance to be displayed.)
	Filter information		Use to check the filter status. • The filter sign can be reset.
	Cleaning	Auto descending panel	Use to lift and lower the auto descending panel (Optional parts).
Service	Test run		Select "Test run" from the Service menu to bring up the Test run menu. • Test run • Drain pump test run
	Input maintenance info.		Select "Input maintenance Info." from the Service menu to bring up the Maintenance information screen. The following settings can be made from the Maintenance Information screen. • Model name input • Serial No. input • Dealer information input • Initialize maintenance info.
	Settings	Function setting	Make the settings for the indoor unit functions via the remote controller as necessary.
		LOSSNAY setting	This setting is required only when the operation of CITY MULTI units is interlocked with LOSSNAY units.
	Check	Error history	Display the error history and execute "delete error history".
		Diagnosis	Self check: Error history of each unit can be checked via the remote controller. Remote controller check: When the remote controller does not work properly, use the remote controller checking function to troubleshoot the problem.
	Others	Maintenance password	Use to change the maintenance password.
		Initialize remote controller	Use to initialize the remote controller to the factory shipment status.
Remote controller information		Use to display the remote controller model name, software version, and serial number.	

<PAR-SL97A-E>

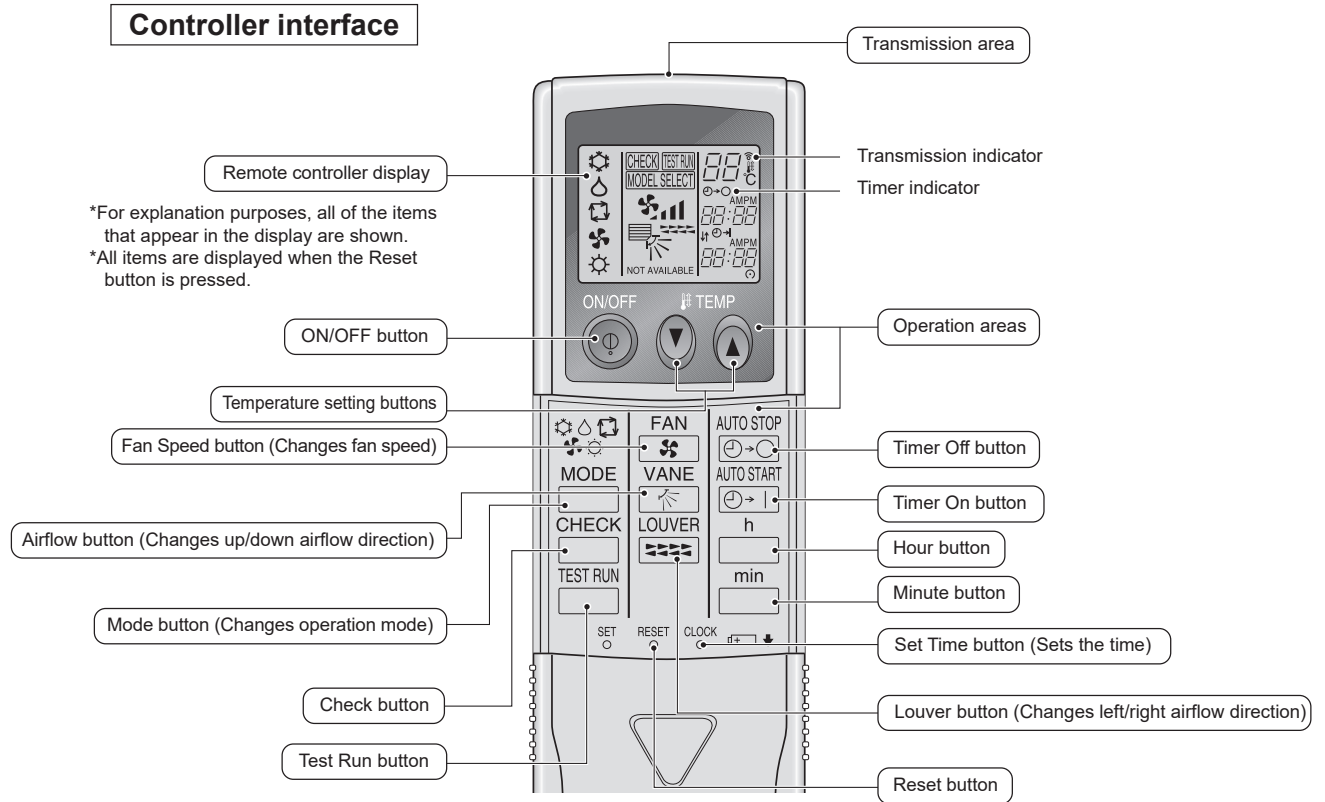

- When using the wireless remote controller, point it towards the receiver on the indoor unit.
- If the remote controller is operated within approximately two minutes after power is supplied to the indoor unit, the indoor unit may beep twice as the unit is performing the initial automatic check.
- The indoor unit beeps to confirm that the signal transmitted from the remote controller has been received. Signals can be received up to approximately 7 meters in a direct line from the indoor unit in an area 45° to the left and right of the unit. However, illumination such as fluorescent lights and strong light can affect the ability of the indoor unit to receive signals.
- If the operation lamp near the receiver on the indoor unit is blinking, the unit needs to be inspected. Consult your dealer for service.
- Handle the remote controller carefully! Do not drop the remote controller or subject it to strong shocks. In addition, do not get the remote controller wet or leave it in a location with high humidity.
- To avoid misplacing the remote controller, install the holder included with the remote controller on a wall and be sure to always place the remote controller in the holder after use.

<PAR-SL100A-E>

Controller interface

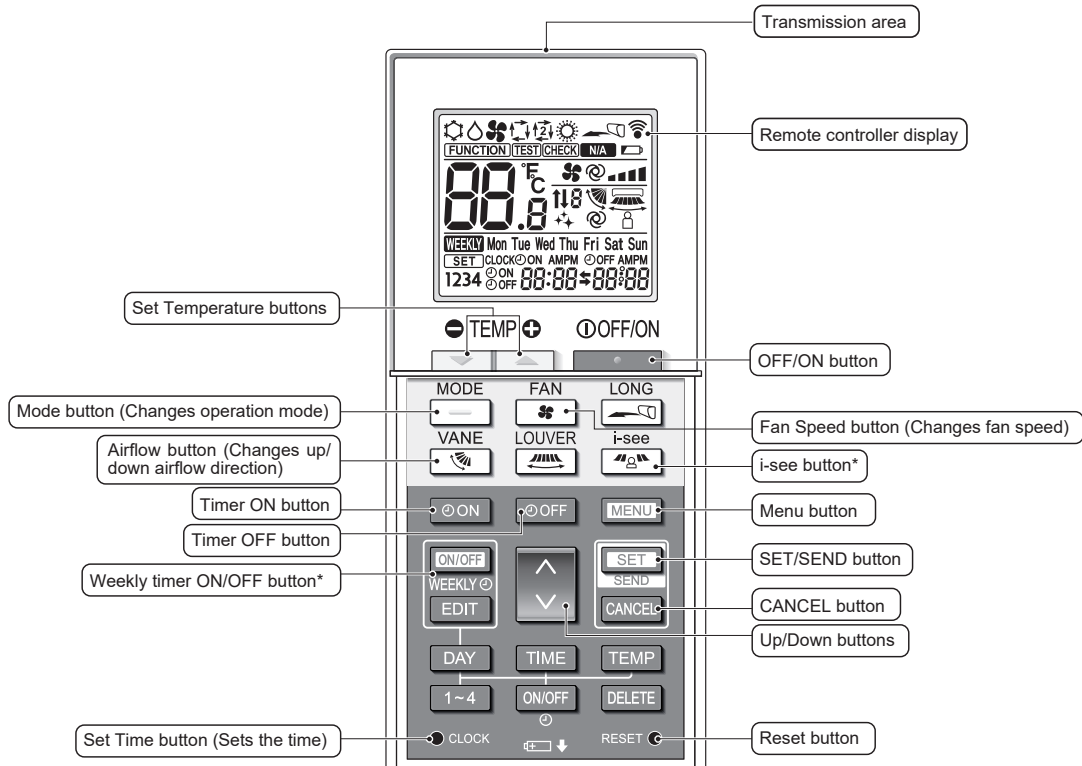

Note:

* This button is enabled or disabled depending on the model of the indoor unit.

Display

Operation mode

- Cool (snowflake icon)
- Dry (water drop icon)
- Fan (fan icon)
- Auto (single set point) (fan with square icon)
- Heat (sun icon)
- Auto (dual set point) (fan with square and sun icon)

Temperature setting
The units of temperature can be changed. For details, refer to the Installation Manual.

Vane setting

Step 1 Step 2 Step 3 Step 4 Step 5 Swing Auto

Not available
Appears when a non-supported function is selected.

Battery replacement indicator
Appears when the remaining battery power is low.

Fan speed setting

Auto

3D i-See sensor (Air distribution)

Default Direct Indirect

When Direct or Indirect is selected, the vane setting is set to "Auto".

<PAR-U02MEDA>

Controller interface

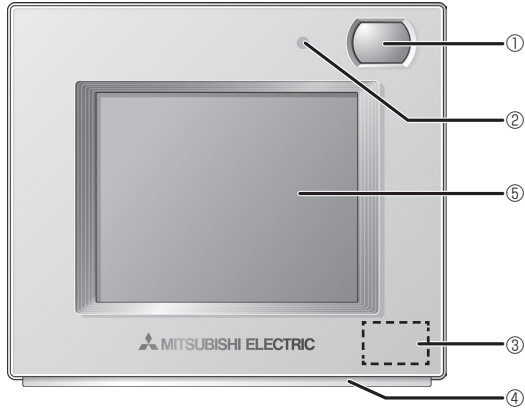

① Occupancy Sensor

The occupancy sensor detects vacancy for energy saving control.

② Brightness Sensor

The brightness sensor detects the brightness of the room for energy saving control.

③ Temperature & Humidity Sensor

The sensor detects the room temperature and the relative humidity.

④ LED Indicator

The LED indicator indicates the operation status in different colors. The LED indicator lights up during normal operation, lights off when units are stopped, and blinks when an error occurs.

⑤ Touch panel & Backlit LCD

The touch panel shows the operation settings screen. When the backlight is off, touching the panel turns the backlight on, and it will stay lit for a predetermined period of time.

12-2. ERROR INFORMATION

**When an error occurs, the following screen will appear.
Check the error status, stop the operation, and consult your dealer.**

1. Check code, error unit, refrigerant address, date and time of occurrence, model name, and serial number will appear.
The model name and serial number will appear only if the information have been registered.

Press the **[F1]** or **[F2]** button to go to the next page.

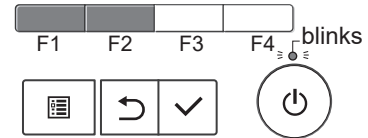
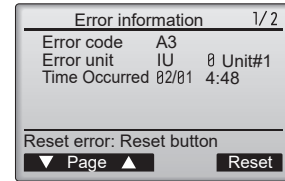

Contact information (dealer's phone number) will appear if the information has been registered.

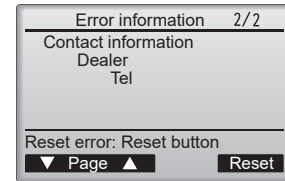

2. Press the **[F4]** button or the  button to reset the error that is occurring.

Errors cannot be reset while the ON/OFF operation is prohibited.

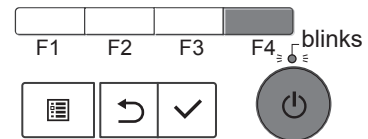
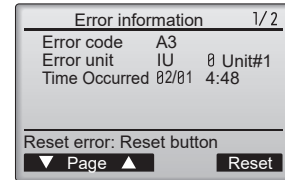

Select "OK" with the **[F4]** button.

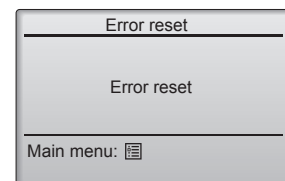
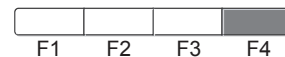
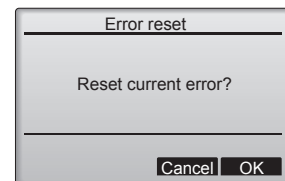

Navigating through the screens

- To go back to the Service menu  button

• Checking the error information

While no errors are occurring, page 2/2 of the error information can be viewed by selecting "Error information" from the Maintenance menu. Errors cannot be reset from this screen.

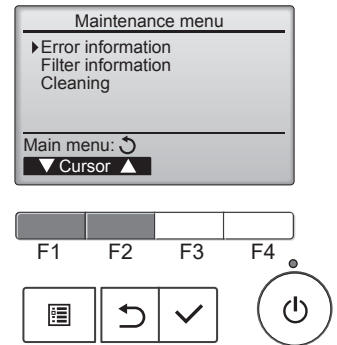

12-3. SERVICE MENU

Maintenance password is required

1. Select "Service" from the Main menu, and press the [✓] button.

*At the main display, the menu button and select "Service" to make the maintenance setting.

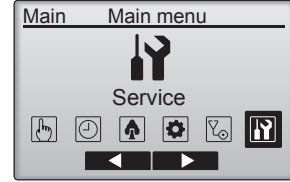

2. When the Service menu is selected, a window will appear asking for the password.

To enter the current maintenance password (4 numerical digits), move the cursor to the digit you want to change with the [F1] or [F2] button.



Set each number (0 through 9) with the [F3] or [F4] button.



Then, press the [✓] button.

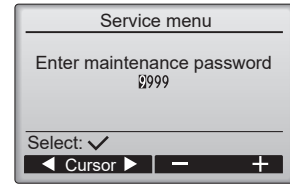

Note: The initial maintenance password is "9999". Change the default password as necessary to prevent unauthorized access. Have the password available for those who need it.

: If you forget your maintenance password, you can initialize the password to the default password "9999" by pressing and holding the [F1] button for 10 seconds on the maintenance password setting screen.

3. If the password matches, the Service menu will appear.

The type of menu that appears depends on the connected indoor units' type.



Note: Air conditioning units may need to be stopped to make only at "Settings". There may be some settings that cannot be made when the system is centrally controlled.

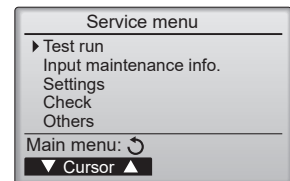

A screen will appear that indicates the setting has been saved.



Navigating through the screens

- To go back to the Service menu[] button
- To return to the previous screen.....[] button

12-4. TEST RUN

12-4-1. PAR-4xMAA

("x" represents 0 or later)

1. Select "Service" from the Main menu, and press the [✓] button.



Select "Test run" with the [F1] or [F2] button, and press the [✓] button.

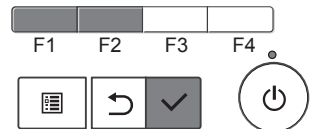
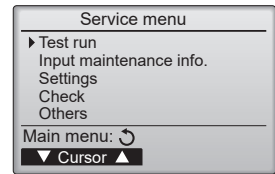

2. Select "Test run" with the [F1] or [F2] button, and press the [✓] button.

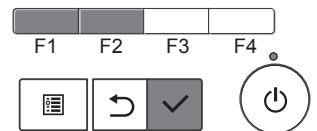
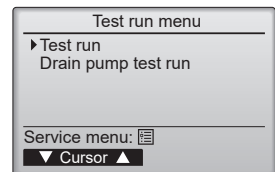

Test run operation

Press the [F1] button to go through the operation modes in the order of "Cool and Heat".

Cool mode: Check the cold air blows out.
Heat mode: Check the heat blows out.

Check the operation of the outdoor unit's fan.



Press the [✓] button and open the Vane setting screen.

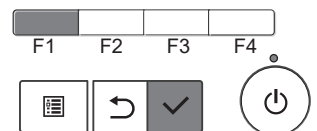
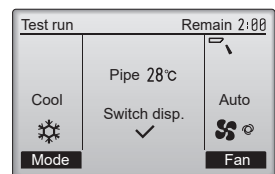

Auto vane check

Check the auto vane with the [F1] [F2] [F3] buttons.



Press the [Return] button to return to "Test run operation".



Press the [Power] button.





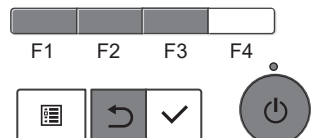
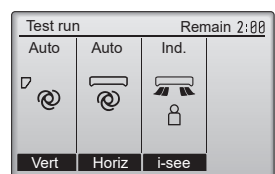





When the test run is completed, the "Test run menu" screen will appear.
The test run will automatically stop after 2 hours.

*The function is available only for the model with vanes.



12-4-2. PAR-SL97A-E

Measure an impedance between the power supply terminal block on the outdoor unit and ground with a 500 V Megger and check that it is equal to or greater than 1.0 MΩ.







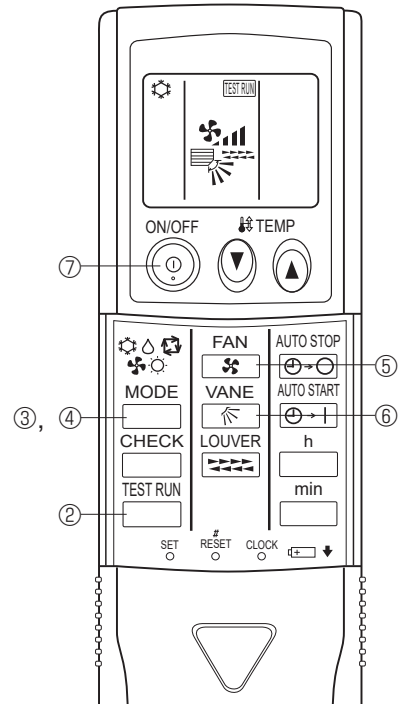







1. Turn on the main power to the unit.
2. Press the  button twice continuously.
(Start this operation from the status of remote controller display turned off.)
A  and current operation mode are displayed.
3. Press the  () button to activate  mode, then check whether cool air blows out from the unit.
4. Press the  () button to activate  mode, then check whether warm air blows out from the unit.
5. Press the  button and check whether strong air blows out from the unit.
6. Press the  button and check whether the auto vane operates properly.
7. Press the ON/OFF button to stop the test run.

Note:

- Point the remote controller towards the indoor unit receiver while following steps 2 to 7.
- It is not possible to run in FAN, DRY or AUTO mode.



12-4-3. PAR-SL100A-E

1. Press the  button ① to stop the air conditioner.
 - If the weekly timer is enabled ( is on), press the  button 3 to disable it ( is off).
2. Press the  button ② for 5 seconds.
 -  comes on and the unit enters the service mode.
3. Press the  button ②.
 -  ③ comes on and the unit enters the test run mode.
4. Press the following buttons to start the test run.
 - : Switch the operation mode between cooling and heating and start the test run.
 - : Switch the fan speed and start the test run.
 - : Switch the airflow direction and start the test run.
 - : Switch the louver and start the test run.
 - : Start the test run.
5. Stop the test run.
 - Press the  button ① to stop the test run.
 - After 2 hours, the stop signal is transmitted.

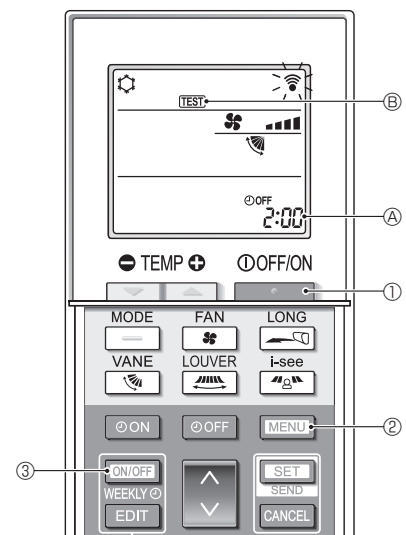

12-4-4. PAR-U02MEDA

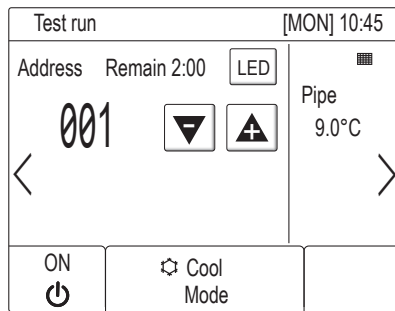

[Test run screen]

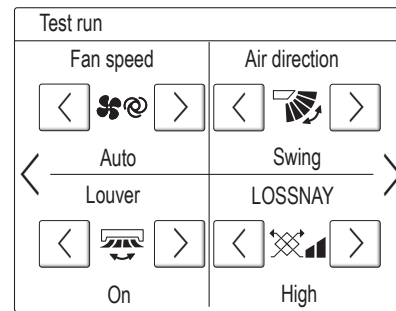

[Indoor unit setting screen]

- (a) Read the section about Test run in the indoor unit Installation Manual before performing a test run.
- (b) During the test run, indoor units will be forced to operate in the Thermo-ON status.
Except the set temperature, normal operation functions are accessible during test run.
- (c) By selecting the address of another indoor unit, the liquid pipe temperature of the selected unit can be monitored.
- (d) The test run will automatically end in two hours.

* When AHC is controlled from the controller

To monitor the operating status of AHC, touch the [<] button on the [Test run] screen and access the [General equipment] screen.

To set the humidity setting for the humidifier (when one is connected to the AHC), touch the [>] button on the [Indoor unit setting] screen.

12-5. FUNCTION SETTING

12-5-1. PAR-4xMAA

("x" represents 0 or later)

1. Select "Service" from the Main menu, and press the [✓] button.



Select "Setting" from the Service menu, and press the [✓] button.



Select "Function setting", and press the [✓] button.

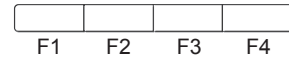
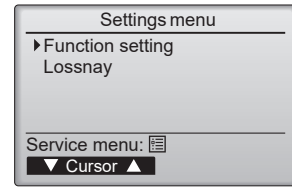

2. The Function setting screen will appear.

Press the [F1] or [F2] button to move the cursor to one of the following: M-NET address, function setting number, or setting value. Then, press the [F3] or [F4] button to change the settings to the desired settings.



Once the settings have been completed, press the [✓] button.

A screen will appear indicating that the settings information is being sent.

To check the current settings of a given unit, enter the setting for its M-NET address and function setting number, select Conf for the Function, and press the [✓] button.

A screen will appear indicating that the settings are being searched for. When the search is done, the current settings will appear.



When the settings information has been sent, a screen will appear indicating its completion.

To make additional settings, press the [↺] button to return to the screen shown in the above step. Set the function numbers for other indoor units by following the same steps.

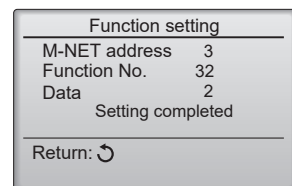
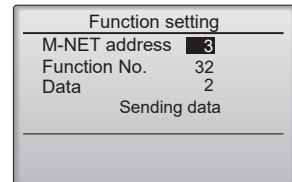
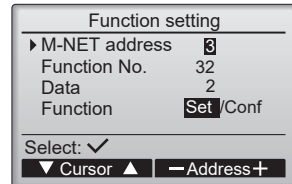

Note:

- Refer to the indoor unit Installation Manual for information about the factory settings of indoor units, function setting numbers, and setting values.
- Be sure to write down the settings for all functions if any of the initial settings has been changed after the completion of installation work.

12-5-2. PAR-SL97A-E

Functions can be selected with the wireless remote controller. Function selection using wireless remote controller is available only for refrigerant system with wireless function. Refrigerant address cannot be specified by the wireless remote controller.

[Flow of function selection procedure]

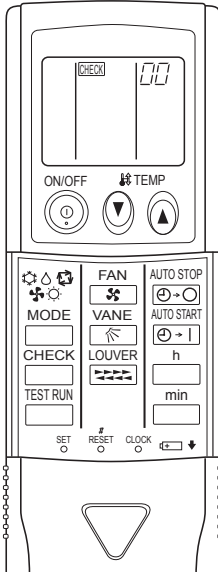

The flow of the function selection procedure is shown below. This example shows how to turn off the function that raises the set temperature by 4 degrees during HEAT operation. (Mode 24: 2)
The procedure is given after the flow chart.

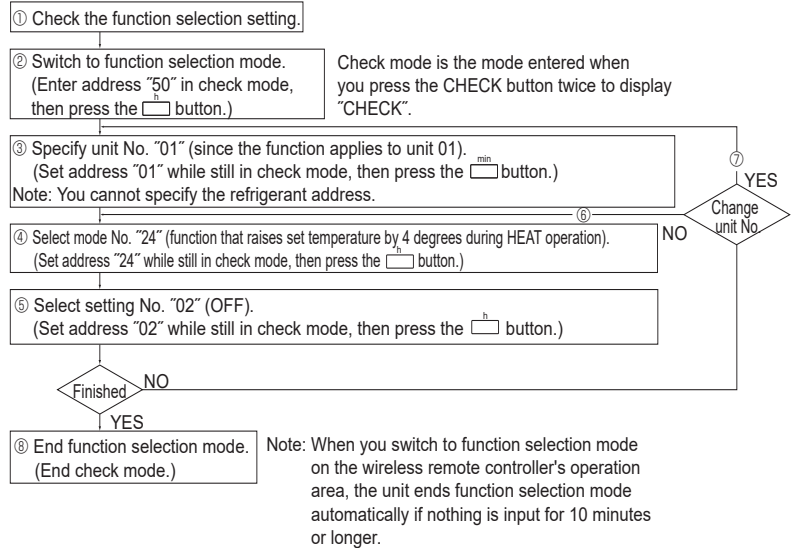

[Operating instructions]

1. Check the function settings.

2. Press the button twice continuously. → **CHECK** is lit and "00" blinks.

Press the button once to set "50". Direct the wireless remote controller toward the receiver of the indoor unit and press the button.

3. Set the unit number.

Press the button to set the unit number. (Press "01" to specify the indoor unit whose unit number is 01.)
Direct the wireless remote controller toward the receiver of the indoor unit and press the button.

By setting unit number with the button, specified indoor unit starts performing fan operation.

Detect which unit is assigned to which number using this function. If unit number is set to AL, all the indoor units in same refrigerant system start performing fan operation simultaneously.

Notes:

1. If a unit number that cannot be recognized by the unit is entered, 3 beeps of 0.4 seconds will be heard. Reenter the unit number setting.
2. If the signal was not received by the sensor, you will not hear a beep or a "double beep" may be heard. Reenter the unit number setting.

4. Select a mode.

Press the button to set a mode. Press "24" to turn on the function that raises the set temperature by 4 degrees during heat operation. Direct the wireless remote controller toward the sensor of the indoor unit and press the button.
→ The sensor-operation indicator will blink and beeps will be heard to indicate the current setting number.

Current setting number: 1 = 1 beep (1 second)
2 = 2 beeps (1 second each)
3 = 3 beeps (1 second each)

Notes:

1. If a mode number that cannot be recognized by the unit is entered, 3 beeps of 0.4 seconds will be heard. Reenter the mode number.
2. If the signal was not received by the sensor, you will not hear a beep or a "double beep" may be heard. Reenter the mode number.

5. Select the setting number.

Press the button to select the setting number. (02: Not available)
Direct the wireless remote controller toward the receiver of the indoor unit and press the button.
→ The sensor-operation indicator will blink and beeps will be heard to indicate the setting number.

Setting number: 1 = 2 beeps (0.4 seconds each)
2 = 2 beeps (0.4 seconds each, repeated twice)
3 = 2 beeps (0.4 seconds each, repeated 3 times)

Notes:

1. If a setting number that cannot be recognized by the unit is entered, the setting will turn back to the original setting.
 2. If the signal was not received by the sensor, you will not hear a beep or a "double beep" may be heard. Reenter the setting number.
6. Repeat steps ④ and ⑤ to make an additional setting without changing unit number.
7. Repeat steps ③ to ⑤ to change unit number and make function settings on it.
8. Complete the function settings

Press button.

Do not use the wireless remote controller for 30 seconds after completing the function setting.

12-5-3. PAR-SL100A-E

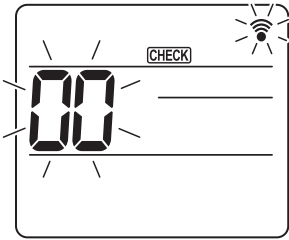

Fig. 1

1. Going to the function select mode

Press the **MENU** button between of 5 seconds.

(Start this operation from the status of remote controller display turned off.)

[CHECK] is lit and "00" blinks. (Fig. 1)

Press the **↓** button to set the "50".

Direct the wireless remote controller toward the receiver of the indoor unit and press the **SET** button.

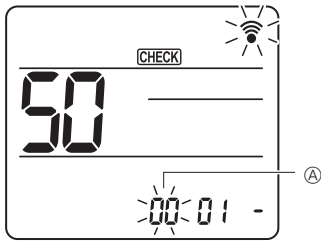

Fig. 2

2. Setting the unit number

Press the **↓** button to set unit number **Ⓐ**. (Fig. 2)

Direct the wireless remote controller toward the receiver of the indoor unit and press the **SET** button.

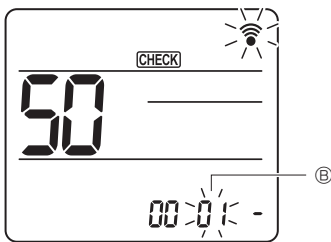

Fig. 3

3. Select a mode

Press the **↓** button to set Mode number **Ⓑ**. (Fig. 3)

Direct the wireless remote controller toward the receiver of the indoor unit and press the **SET** button.

Current setting number:

1=1 beep (1 second)

2=2 beep (1 second each)

3=3 beep (1 second each)

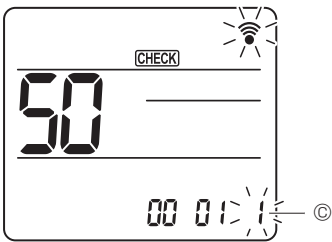

Fig. 4

4. Selecting the setting number

Use the **↓** button to change the Setting number **Ⓒ**. (Fig. 4)

Direct the wireless remote controller toward the receiver of the indoor unit and press the **SET** button.

5. To select multiple functions continuously

Repeat select **Ⓒ** and **Ⓓ** to change multiple function settings continuously.

6. Complete function selection

Direct the wireless remote controller toward the sensor of the indoor unit and press the **OFF/ON** button.

Note: Be sure to write down the settings for all functions if any of the initial settings has been changed after the completion of installation work.

12-6. ERROR HISTORY

1. Select "Service" from the Main menu, and press the [✓] button.



Select "Check" with the [F1] or [F2] button, and press the [✓] button.

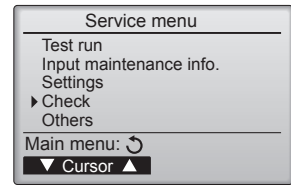

2. Select "Error history" with the [F1] or [F2] button, and press the [✓] button.

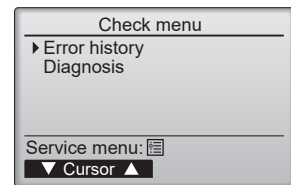

3. 16 error history records will appear.

4 records are shown per page, and the top record on the first page indicates the latest error record.

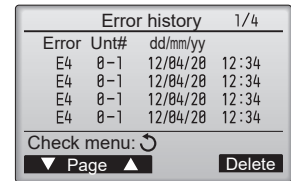

4. Deleting the error history

To delete the error history, press the [F4] button (Delete) on the screen that shows error history.

A confirmation screen will appear asking if you want to delete the error history.



Press the [F4] button (OK) to delete the history.



"Error history deleted" will appear on the screen.

Press the [↻] button to go back to the Check menu screen.

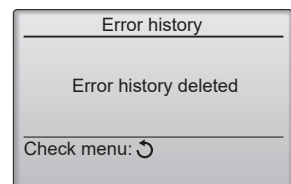
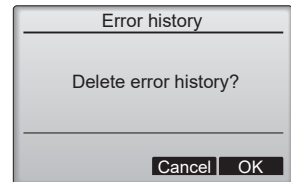

12-7. SELF-DIAGNOSIS

12-7-1. PAR-4xMAA

("x" represents 0 or later)

1. Select "Service" from the Main menu, and press the [✓] button.

Select "Check" from the Service menu, and press the [✓] button.

Select "Diagnosis" from the Check menu, and press the [✓] button.

Select "Self check" with the [F1] or [F2] button, and press the [✓] button.

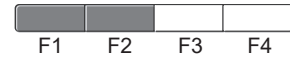
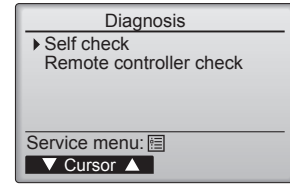

2. Select "Self check" from the Diagnosis menu, and press the [✓] button to view the Self check screen.

With the [F1] or [F2] button, enter the M-NET address, and press the [✓] button.

Check code, unit number, attribute, and indoor unit demand signal ON/OFF status at the contact will appear. "-" will appear if no error history is available.

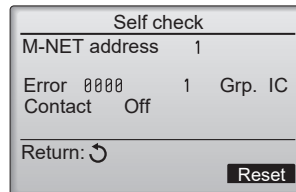
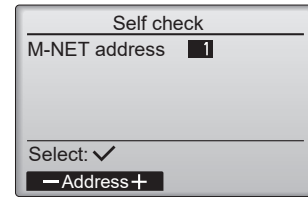

When there is no error history

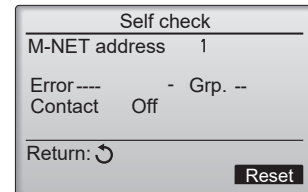

3. Resetting the error history

Press the [F4] button (Reset) on the screen that shows the error history. A confirmation screen will appear asking if you want to delete the error history.

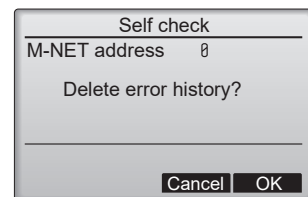

Press the [F4] button (OK) to delete the error history. If deletion fails, "Request rejected" will appear, and "Unit not exist" will appear if indoor units that correspond to the entered address are not found.

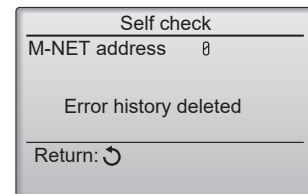

12-7-2. PAR-SL97A-E

When a malfunction occurs to air conditioner, both indoor unit and outdoor unit will stop and operation lamp blinks to inform unusual stop.

<Malfunction-diagnosis method at maintenance service>

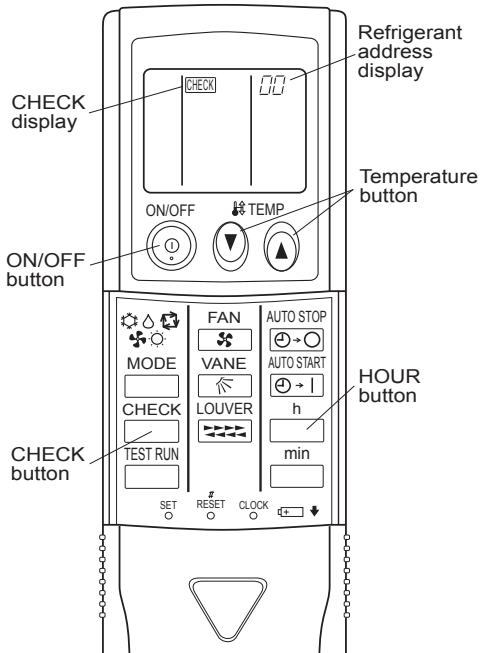

[Procedure]

1. Press the CHECK button twice.
 - "CHECK" lights, and refrigerant address "00" blinks.
 - Check that the remote controller's display has stopped before continuing.
2. Press the TEMP \downarrow \uparrow buttons.
 - Select the refrigerant address of the indoor unit for the self-diagnosis.
 - Note: Set refrigerant address using the outdoor unit's DIP switch (SW1). (For more information, see the outdoor unit installation manual.)
3. Point the remote controller at the sensor on the indoor unit and press the HOUR button.
 - If an air conditioner error occurs, the indoor unit's sensor emits an intermittent buzzer sound, the operation light blinks, and the check code is output. (It takes 3 seconds at most for check code to appear.)
4. Point the remote controller at the sensor on the indoor unit and press the ON/OFF button.
 - The check mode is cancelled.

12-7-3. PAR-SL100A-E

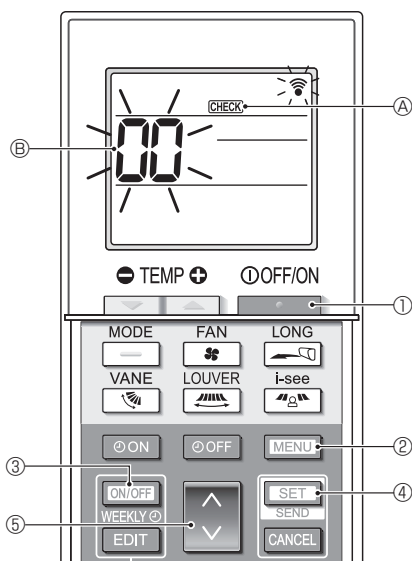

1. Press the \downarrow button ① to stop the air conditioner.
 - If the weekly timer is enabled (WEEKLY is on), press the ON/OFF WEEKLY button ③ to disable it (WEEKLY is off).
2. Press the MENU button ② for 5 seconds.
 - CHECK ④ comes on and the unit enters the self-check mode.
3. Press the \downarrow button ⑤ to select the refrigerant address (M-NET address) ⑥ of the indoor unit for which you want to perform the self-check.
4. Press the SET button ④.
 - If an error is detected, the check code is indicated by the number of beeps from the indoor unit and the number of blinks of the OPERATION INDICATOR lamp.
5. Press the \downarrow button ①.
 - CHECK ④ and the refrigerant address (M-NET address) ⑥ go off and the self-check is completed.

12-8. REMOTE CONTROLLER CHECK

If operations cannot be completed with the remote controller, diagnose the remote controller with this function.

1. Select "Service" from the Main menu, and press the [✓] button.



Select "Check" from the Service menu, and press the [✓] button.



Select "Diagnosis" from the Check menu, and press the [✓] button.



Select "Remote controller check" with the [F1] or [F2] button, and press the [✓] button.

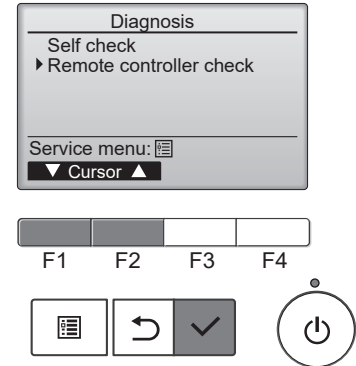

2. Select "Remote controller check" from the Diagnosis menu, and press the [✓] button to start the remote controller check and see the check results.



To cancel the remote controller check and exit the "Remote controller check" menu screen, press the [⌂] or the [↺] button.



The remote controller will not reboot itself.

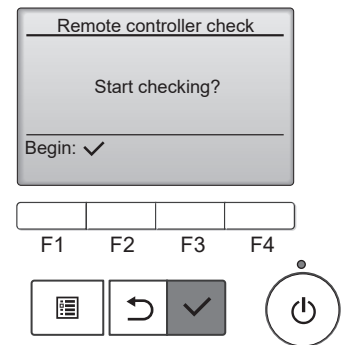

3.
 - OK: No problems are found with the remote controller. Check other parts for problems.
 - E3, 6832: There is noise on the transmission line, or the indoor unit or another remote controller is faulty. Check the transmission line and the other remote controllers.
 - NG (ALL0, ALL1): Send-receive circuit fault. The remote controller needs replacing.
 - ERC: The number of data errors is the discrepancy between the number of bits in the data transmitted from the remote controller and that of the data that was actually transmitted over the transmission line. If data errors are found, check the transmission line for external noise interference.



If the [✓] button is pressed after the remote controller check results are displayed, remote controller check will end, and the remote controller will automatically reboot itself.

Remote controller check results screen

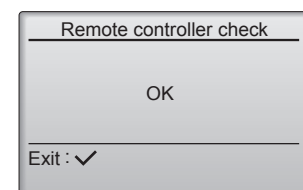

Check the remote controller display and see if anything is displayed (including lines). Nothing will appear on the remote controller display if the correct voltage (8.5–12 VDC) is not supplied to the remote controller. If this is the case, check the remote controller wiring and indoor units.

12-9. SPECIAL FUNCTION OPERATION SETTING

<PAR-U02MEDA>

*M-NET remote controller cannot be connected with a refrigerant system which includes branch box.

It is necessary to perform “group settings” and “Interlocked LOSSNAY” at making group settings of different refrigerant systems (multiple outdoor unit).

- (A) Group settings: Enter the indoor unit controlled by the remote controller, check the content of entries, and clear entries, etc.
- (B) Interlocked LOSSNAY: Used to set the linked operation of a Lossnay unit.

How to display the setup screen

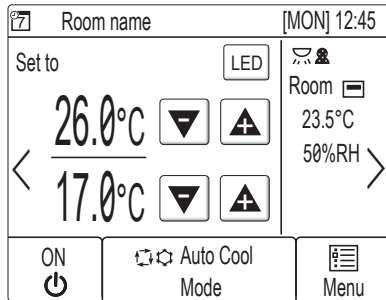

- HOME screen

Touch the [MENU] button.

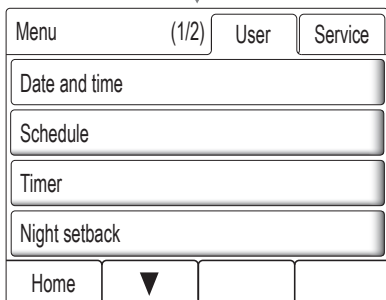

- Menu (User) screen

Touch the [Service] button.

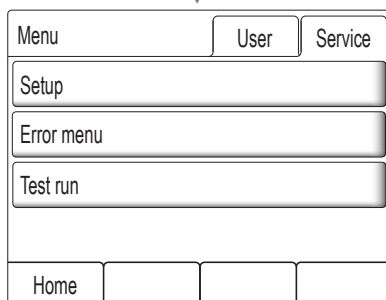

- Menu (Service) screen

Touch the [Setup] button.
Setup screen will appear.

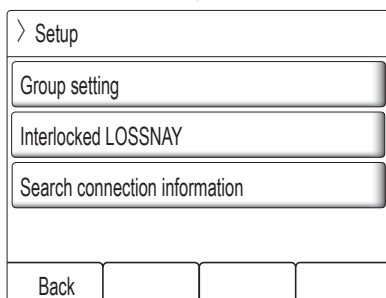

(a) Group setting

Use this screen to register the indoor units and the AHC to be controlled from the controller.

[Group setting]	
IC 001 002 003 004 005 006 007 008 009 010 011 012 013 014 015 016	Address <input type="button" value="▼"/> 001 <input type="button" value="▲"/> Unit IC Function <input type="button" value="Set"/> <input type="button" value="Del"/>
AHC 201	
Back	

1. Select an indoor unit or an AHC address in the [Address] field.
The number of units that can be registered.
Indoor unit: 16 units maximum
AHC: 1 unit maximum
* AHC cannot be controlled from the controller unless indoor units are registered with the system.
2. Touch the [Set] button to register the address, and [Del] to delete the address.
 - Successful address registration/deletion:
The registered address(es) will appear on the left side of the screen.
Deleted address will not appear on the screen.
 - Error:
"Request denied." or "Is not to be connected" will appear.

(b) Interlocked LOSSNAY

Use this function to interlock the operation of indoor units and LOSSNAY units.

[Interlocked LOSSNAY]	
001 IC 007 IC 002 IC 008 IC 003 IC 009 IC 004 IC 010 IC 005 IC 011 IC 006 IC 012 IC	Add. 1 <input type="button" value="▼"/> 001 <input type="button" value="▲"/> Add. 2 <input type="button" value="▼"/> 013 <input type="button" value="▲"/> Function <input type="button" value="Set"/> <input type="button" value="Conf"/> <input type="button" value="Del"/>
Back	

1. To register LOSSNAY units
Select the indoor unit address in the Add. 1 section.
Select the interlocked LOSSNAY address in the Add. 2 section.
Touch the [Set] button to save the setting.
2. To search for an interlocked setting
Touch the [Conf] button to display in the left column the addresses of the units that are interlocked with the unit whose address was set in the Add. 1 section.
3. To delete the interlock settings
After taking Step 2 above, select the address to be deleted in the Add. 2 section, and then touch the [Del] button.

When the setting or deletion is successfully completed, "Completed" will appear below [Function] field on the screen. If setting or deletion fails, "Request denied" will appear below [Function] field on the screen.

(c) Search connection information

Use this screen to specify a unit and search for the controllers that are connected to the unit.

[Search connection information]	
001 IC 002 IC 003 IC 004 IC 005 IC 006 IC	Address <input type="button" value="▼"/> 051 <input type="button" value="▲"/> Function <input type="button" value="Conf"/>
Back	

1. Select an address in the [Address] field.
2. Touch the [Conf] button to search for the interlocked units.
The results will appear in the left column. (When multiple units are found, the addresses that do not fit on the first page will appear on the successive pages.)
 - Search error:
"Request denied." will appear.

After completing the settings, touch the [Back] button on the [Setup] screen. The message "Collecting the information from the air conditioner." will appear, and then the screen will jump to the HOME screen. This signals the completion of the setup process. Access the Service Menu from the HOME screen to make the settings for other items as necessary.

mitsubishi electric corporation

HEAD OFFICE: TOKYO BUILDING, 2-7-3, MARUNOUCHI, CHIYODA-KU, TOKYO100-8310, JAPAN

MITSUBISHI ELECTRIC CONSUMER PRODUCTS (THAILAND) CO., LTD.
700/406 MOO 7, TAMBON DON HUA ROH,
AMPHUR MUANG, CHONBURI 20000 THAILAND
Issued: Apr. 2024. No. TCH091 REVISED EDITION-A
Published: Jul. 2022. No. TCH091
Made in Thailand

Specifications are subject to change without notice.