

SPLIT-TYPE AIR CONDITIONERS

Revision A:

- Some descriptions have been corrected for 4. SPECIFICATION, 8. REFRIGERANT SYSTEM DIAGRAM and others.

OBH817 is void.

OUTDOOR UNIT

SERVICE MANUAL



No. OBH817
REVISED EDITION-A

Models

MUY-TP35VF - E1, ET1

MUY-TP50VF - E1, ET1

Indoor unit service manual
MSY-TP•VF Series (OBH816)

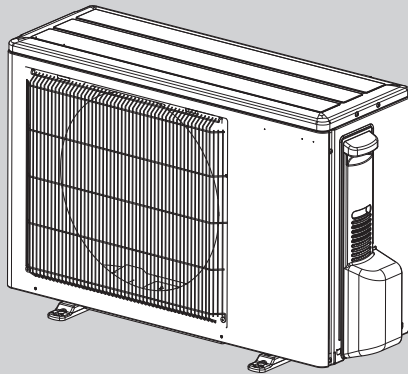

CONTENTS

1. TECHNICAL CHANGES	2
2. SERVICING PRECAUTIONS FOR UNITS USING REFRIGERANT R32.....	3
3. PART NAMES AND FUNCTIONS.....	5
4. SPECIFICATION.....	6
5. NOISE CRITERIA CURVES	8
6. OUTLINES AND DIMENSIONS	9
7. WIRING DIAGRAM.....	10
8. REFRIGERANT SYSTEM DIAGRAM	11
9. PERFORMANCE CURVES	12
10. ACTUATOR CONTROL	19
11. TROUBLESHOOTING	20
12. DISASSEMBLY INSTRUCTIONS.....	39

PARTS CATALOG (OBB817)

Use the specified refrigerant only

Never use any refrigerant other than that specified.

Doing so may cause a burst, an explosion, or fire when the unit is being used, serviced, or disposed of.

Correct refrigerant is specified in the manuals and on the spec labels provided with our products.

We will not be held responsible for mechanical failure, system malfunction, unit breakdown or accidents caused by failure to follow the instructions.

<Preparation before the repair service>

- Prepare the proper tools.
- Prepare the proper protectors.
- Provide adequate ventilation.
- After stopping the operation of the air conditioner, turn off the power-supply breaker and remove the power plug.
- Discharge the capacitor before the work involving the electric parts.

<Precautions during the repair service>

- Do not perform the work involving the electric parts with wet hands.
- Do not pour water into the electric parts.
- Do not touch the refrigerant.
- Do not touch the hot or cold areas in the refrigeration cycle.
- When the repair or the inspection of the circuit needs to be done without turning off the power, exercise great caution not to touch the live parts.

Revision A:

- Some descriptions have been corrected for 4. SPECIFICATION, 8. REFRIGERANT SYSTEM DIAGRAM and others.

1

TECHNICAL CHANGES

MUY-TP35VF - [E1](#), [ET1](#)

MUY-TP50VF - [E1](#), [ET1](#)

1. New model

Servicing precautions for units using refrigerant R32

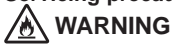

This unit uses a flammable refrigerant.

If refrigerant leaks and comes in contact with fire or heating part, it will create harmful gas and there is risk of fire.

- Do not use means to accelerate the defrosting process or to clean, other than those recommended by the manufacturer.
- The appliance shall be stored in a room without continuously operating ignition sources (for example: open flames, an operating gas appliance or an operating electric heater.)
- Do not pierce or burn.
- Be aware that refrigerants may not contain an odor.
- Pipe-work shall be protected from physical damage.
- The installation of pipe-work shall be kept to a minimum.
- Compliance with national gas regulations shall be observed.
- Keep any required ventilation openings clear of obstruction.
- Servicing shall be performed only as recommended by the manufacturer.
- The appliance shall be stored so as to prevent mechanical damage from occurring.

Basic work procedures are the same as those for conventional units using refrigerant R410A. However, pay careful attention to the following points.

1. Information on servicing
 - ① Checks on the Area

Prior to beginning work on systems containing flammable refrigerants, safety checks are necessary to ensure that the risk of ignition is minimized.
 - ② Work Procedure

Work shall be undertaken under a controlled procedure so as to minimize the risk of a flammable gas or vapor being present while the work is being performed.
 - ③ General Work Area

All maintenance staff and others working in the local area shall be instructed on the nature of work being carried out. Work in confined spaces shall be avoided. The area around the workspace shall be sectioned off. Ensure that the conditions within the area have been made safe by control of flammable material.
 - ④ Checking for Presence of Refrigerant

The area shall be checked with an appropriate refrigerant detector prior to and during work, to ensure the technician is aware of potentially toxic or flammable atmospheres. Ensure that the leak detection equipment being used is suitable for use with all applicable refrigerants, i.e. non-sparking, adequately sealed or intrinsically safe.
 - ⑤ Presence of Fire Extinguisher

If any hot work is to be conducted on the refrigeration equipment or any associated parts, appropriate fire extinguishing equipment shall be available to hand. Have a dry powder or CO2 fire extinguisher adjacent to the charging area.
 - ⑥ No Ignition Sources

No person carrying out work in relation to a refrigeration system which involves exposing any pipe work shall use any sources of ignition in such a manner that it may lead to the risk of fire or explosion. All possible ignition sources, including cigarette smoking, should be kept sufficiently far away from the site of installation, repairing, removing and disposal, during which refrigerant can possibly be released to the surrounding space. Prior to work taking place, the area around the equipment is to be surveyed to make sure that there are no flammable hazards or ignition risks. "No Smoking" signs shall be displayed.
 - ⑦ Ventilated Area

Ensure that the area is in the open or that it is adequately ventilated before breaking into the system or conducting any hot work. A degree of ventilation shall continue during the period that the work is carried out. The ventilation should safely disperse any released refrigerant and preferably expel it externally into the atmosphere.
 - ⑧ Checks on the Refrigeration Equipment

Where electrical components are being changed, they shall be fit for the purpose and to the correct specification. At all times the manufacturer's maintenance and service guidelines shall be followed. If in doubt, consult the manufacturer's technical department for assistance.

The following checks shall be applied to installations using flammable refrigerants:

 - The charge size is in accordance with the room size within which the refrigerant containing parts are installed.
 - The ventilation machinery and outlets are operating adequately and are not obstructed.
 - If an indirect refrigerating circuit is being used, the secondary circuit shall be checked for the presence of refrigerant.
 - Marking to the equipment continues to be visible and legible. Markings and signs that are illegible shall be corrected.
 - Refrigeration pipe or components are installed in a position where they are unlikely to be exposed to any substance which may corrode refrigerant containing components, unless the components are constructed of materials which are inherently resistant to being corroded or are suitably protected against being corroded.
 - ⑨ Checks on Electrical Devices

Repair and maintenance to electrical components shall include initial safety checks and component inspection procedures. If a fault exists that could compromise safety, then no electrical supply shall be connected to the circuit until it is satisfactorily dealt with. If the fault cannot be corrected immediately but it is necessary to continue operation, an adequate temporary solution shall be used. This shall be reported to the owner of the equipment so all parties are advised.

Initial safety checks shall include that:

 - capacitors are discharged: this shall be done in a safe manner to avoid possibility of sparking;
 - no live electrical components and wiring are exposed while charging, recovering or purging the system;
 - there is continuity of earth bonding
2. Repairs to Sealed Components
 - ① During repairs to sealed components, all electrical supplies shall be disconnected from the equipment being worked upon prior to any removal of sealed covers, etc. If it is absolutely necessary to have an electrical supply to equipment during servicing, then a permanently operating form of leak detection shall be located at the most critical point to warn of a potentially hazardous situation.
 - ② Particular attention shall be paid to the following to ensure that by working on electrical components, the casing is not altered in such a way that the level of protection is affected. This shall include damage to cables, excessive number of connections, terminals not made to original specification, damage to seals, incorrect fitting of glands, etc.

Ensure that the apparatus is mounted securely.

Ensure that seals or sealing materials have not degraded to the point that they no longer serve the purpose of preventing the ingress of flammable atmospheres. Replacement parts shall be in accordance with the manufacturer's specifications.
3. Repair to Intrinsic Safe Components

Do not apply any permanent inductive or capacitance loads to the circuit without ensuring that this will not exceed the permissible voltage and current permitted for the equipment in use.

Intrinsic safe components are the only types that can be worked on while live in the presence of a flammable atmosphere. The test apparatus shall be at the correct rating.

Replace components only with parts specified by the manufacturer. Other parts may result in the ignition of refrigerant in the atmosphere from a leak.
4. Cabling

Check that cabling will not be subject to wear, corrosion, excessive pressure, vibration, sharp edges or any other adverse environmental effects. The check shall also take into account the effects of aging or continual vibration from sources such as compressors or fans.

5. **Detection of Flammable Refrigerants**
Under no circumstances shall potential sources of ignition be used in the searching for or detection of refrigerant leaks. A halide torch (or any other detector using a naked flame) shall not be used.
6. **Leak Detection Methods**
Electronic leak detectors may be used to detect refrigerant leaks but, in the case of flammable refrigerants, the sensitivity may not be adequate, or may need re-calibration. (Detection equipment shall be calibrated in a refrigerant-free area.) Ensure that the detector is not a potential source of ignition and is suitable for the refrigerant used. Leak detection equipment shall be set at a percentage of the LFL of the refrigerant and shall be calibrated to the refrigerant employed, and the appropriate percentage of gas (25 % maximum) is confirmed.
Leak detection fluids are suitable for use with most refrigerants but the use of detergents containing chlorine shall be avoided as the chlorine may react with the refrigerant and corrode the copper pipe-work.
If a leak is suspected, all naked flames shall be removed/extinguished.
If a leakage of refrigerant is found which requires brazing, all of the refrigerant shall be recovered from the system, or isolated (by means of shut off valves) in a part of the system remote from the leak. For appliances containing flammable refrigerants, oxygen free nitrogen (OFN) shall then be purged through the system both before and during the brazing process.
7. **Removal and Evacuation**
When breaking into the refrigerant circuit to make repairs - or for any other purpose conventional procedures shall be used. However, for flammable refrigerants it is important that best practice is followed since flammability is a consideration. The following procedure shall be adhered to:
- remove refrigerant
 - purge the circuit with inert gas
 - evacuate
 - purge again with inert gas
 - open the circuit by cutting or brazing.
- The refrigerant charge shall be recovered into the correct recovery cylinders. For appliances containing flammable refrigerants, the system shall be "flushed" with OFN to render the unit safe. This process may need to be repeated several times. Compressed air or oxygen shall not be used for purging refrigerant systems.
For appliances containing flammable refrigerants, flushing shall be achieved by breaking the vacuum in the system with OFN and continuing to fill until the working pressure is achieved, then venting to atmosphere, and finally pulling down to a vacuum. This process shall be repeated until no refrigerant is within the system. When the final OFN charge is used, the system shall be vented down to atmospheric pressure to enable work to take place. This operation is absolutely vital if brazing operations on the pipe-work are to take place.
Ensure that the outlet for the vacuum pump is not close to any ignition sources and that ventilation is available.
8. **Charging Procedures**
In addition to conventional charging procedures, the following requirements shall be followed:
- Ensure that contamination of different refrigerants does not occur when using charging equipment. Hoses or lines shall be as short as possible to minimize the amount of refrigerant contained in them.
 - Cylinders shall be kept upright.
 - Ensure that the refrigeration system is earthed prior to charging the system with refrigerant.
 - Label the system when charging is complete (if not already).
 - Extreme care shall be taken not to overfill the refrigeration system.
- Prior to recharging the system, it shall be pressure-tested with the appropriate purging gas. The system shall be leak-tested on completion of charging but prior to commissioning. A follow up leak test shall be carried out prior to leaving the site.
9. **Decommissioning**
Before carrying out this procedure, it is essential that the technician is completely familiar with the equipment and all its detail. It is recommended good practice that all refrigerants are recovered safely. Prior to the task being carried out, an oil and refrigerant sample shall be taken in case analysis is required prior to re-use of reclaimed refrigerant. It is essential that electrical power is available before the task is commenced.
- a) Become familiar with the equipment and its operation.
 - b) Isolate system electrically.
 - c) Before attempting the procedure, ensure that:
 - mechanical handling equipment is available, if required, for handling refrigerant cylinders;
 - all personal protective equipment is available and being used correctly;
 - the recovery process is supervised at all times by a competent person;
 - recovery equipment and cylinders conform to the appropriate standards.
 - d) Pump down refrigerant system, if possible.
 - e) If a vacuum is not possible, make a manifold so that refrigerant can be removed from various parts of the system.
 - f) Make sure that cylinder is situated on the scales before recovery takes place.
 - g) Start the recovery machine and operate in accordance with manufacturer's instructions.
 - h) Do not overfill cylinders. (no more than 80 % volume liquid charge).
 - i) Do not exceed the maximum working pressure of the cylinder, even temporarily.
 - j) When the cylinders have been filled correctly and the process completed, make sure that the cylinders and the equipment are removed from site promptly and all isolation valves on the equipment are closed off.
 - k) Recovered refrigerant shall not be charged into another refrigeration system unless it has been cleaned and checked.
10. **Labeling**
Equipment shall be labeled stating that it has been de-commissioned and emptied of refrigerant. The label shall be dated and signed. For appliances containing flammable refrigerants, ensure that there are labels on the equipment stating the equipment contains flammable refrigerant.
11. **Recovery**
When removing refrigerant from a system, either for servicing or decommissioning, it is recommended good practice that all refrigerants are removed safely. When transferring refrigerant into cylinders, ensure that only appropriate refrigerant recovery cylinders are employed. Ensure that the correct number of cylinders for holding the total system charge are available. All cylinders to be used are designated for the recovered refrigerant and labeled for that refrigerant (i.e. special cylinders for the recovery of refrigerant). Cylinders shall be complete with pressure-relief valve and associated shut-off valves in good working order. Empty recovery cylinders are evacuated and, if possible, cooled before recovery occurs.
The recovery equipment shall be in good working order with a set of instructions concerning the equipment that is at hand and shall be suitable for the recovery of all appropriate refrigerants including, when applicable, flammable refrigerants. In addition, a set of calibrated weighing scales shall be available and in good working order. Hoses shall be complete with leak-free disconnect couplings and in good condition. Before using the recovery machine, check that it is in satisfactory working order, has been properly maintained and that any associated electrical components are sealed to prevent ignition in the event of a refrigerant release. Consult manufacturer if in doubt.
The recovered refrigerant shall be returned to the refrigerant supplier in the correct recovery cylinder, and the relevant waste transfer note arranged. Do not mix refrigerants in recovery units and especially not in cylinders.
If compressors or compressor oils are to be removed, ensure that they have been evacuated to an acceptable level to make certain that flammable refrigerant does not remain within the lubricant. The evacuation process shall be carried out prior to returning the compressor to the suppliers. Only electric heating to the compressor body shall be employed to accelerate this process. When oil is drained from a system, it shall be carried out safely.

3

PART NAMES AND FUNCTIONS

MUY-TP35VF
MUY-TP50VF

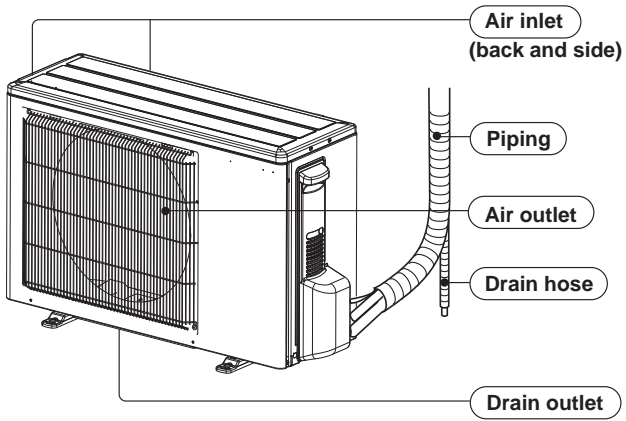

4

SPECIFICATION

*1 Measured under rated operating frequency.

Outdoor model				MUY-TP35VF	MUY-TP50VF
Power supply				Single phase, 230 V, 50 Hz	
Capacity Rated frequency (Min.-Max.)		Cooling	kW	3.5 (1.5-4.0)	5.0 (1.5-5.7)
Breaker Capacity			A	10	
Electrical data	Power input *1 (Set)		Cooling W	760	1,450
	Running current *1 (Set)		Cooling A	3.60	6.40
	Power factor *1 (Set)		Cooling %	91	98
	Starting current *1 (Set)		A	3.60	6.40
Coefficient of performance (COP) *1 (Set)		Cooling	4.61	3.45	
Compressor	Model			SVB130FBBMT	
	Output		W	900	
	Current *1	Cooling	A	3.1	5.9
	Refrigeration oil (Model)			0.35 (FW68S)	
Fan motor	Model			RC0J50-NC	
	Current *1	Cooling	A	0.21	
Dimensions W x H x D			mm	800 x 550 x 285	
Weight			kg	34	
Special remarks	Dehumidification		Cooling L/h	0.1	1.3
	Air flow *1	Cooling	High	1,758	
			Low	984	
	Sound level *1		Cooling dB(A)	45	47
	Fan speed	Cooling	High	810	
			Low	490	
	Fan speed regulator			3	
Refrigerant filling capacity (R32)			kg	0.85	

NOTE: Test conditions are based on ISO 5151.

Cooling: Indoor Dry-bulb temperature 27°C
 Outdoor Dry-bulb temperature 35°C
 Refrigerant piping length (one way): 5 m

Wet-bulb temperature 19°C
 Wet-bulb temperature 24°C

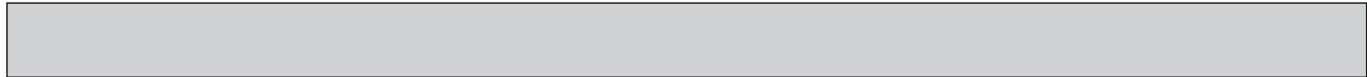

Specifications and rated conditions of main electric parts

Item	Model	MUY-TP35VF	MUY-TP50VF
Smoothing capacitor	(C61)	600 μ F/ 620 μ F 420 V	
	(C62, C63)	600 μ F/ 620 μ F 420 V	
Diode module	(DB61)	15 A 600 V	
Diode module	(DB65)	25 A 600 V	
Fuse	(F61)	25A 250V	
	(F62)	15A 250V	
	(F801, F901)	T3.15AL250V	
Power module	(IC700)	20 A 600 V	
	(IC932)	5 A 600 V	
Expansion valve coil	(LEV)	12 V DC	
Reactor	(L61)	23 mH	
Switch power transistor	(Q821)	30/37A 600V	
Current-limiting PTC thermistor	(PTC64, PTC65)	33 Ω	
Terminal block	(TB1)	3 P	
Relay	(X64)	20 A 250 V	

5 NOISE CRITERIA CURVES

MUY-TP35VF

FUNCTION	SPL(dB(A))	LINE
COOLING	45	●—●

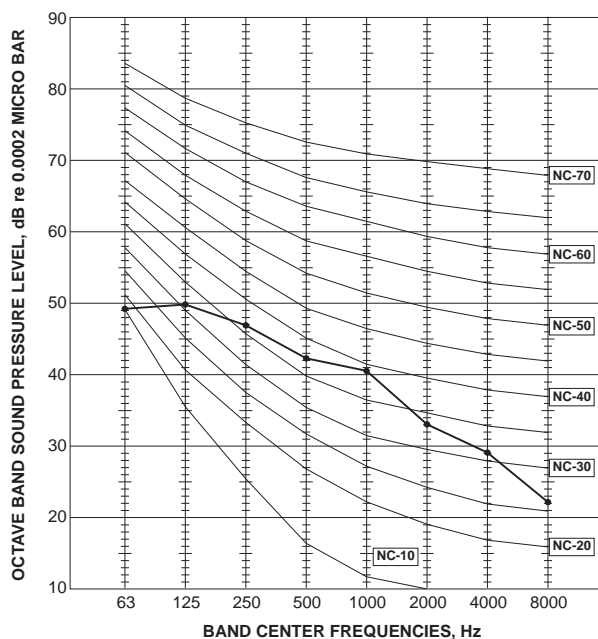

MUY-TP50VF

FUNCTION	SPL(dB(A))	LINE
COOLING	47	●—●

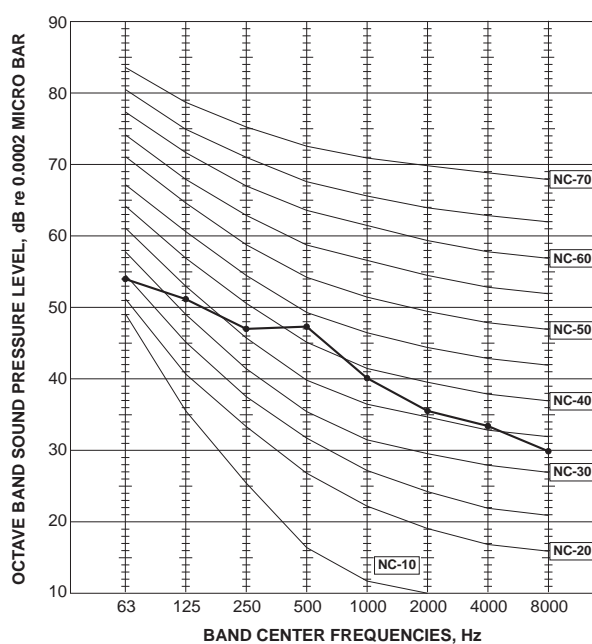

Test conditions

Cooling: Dry-bulb temperature 35°C Wet-bulb temperature 24°C

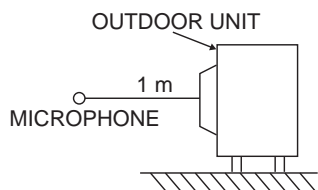

6

OUTLINES AND DIMENSIONS

MUY-TP35VF MUY-TP50VF

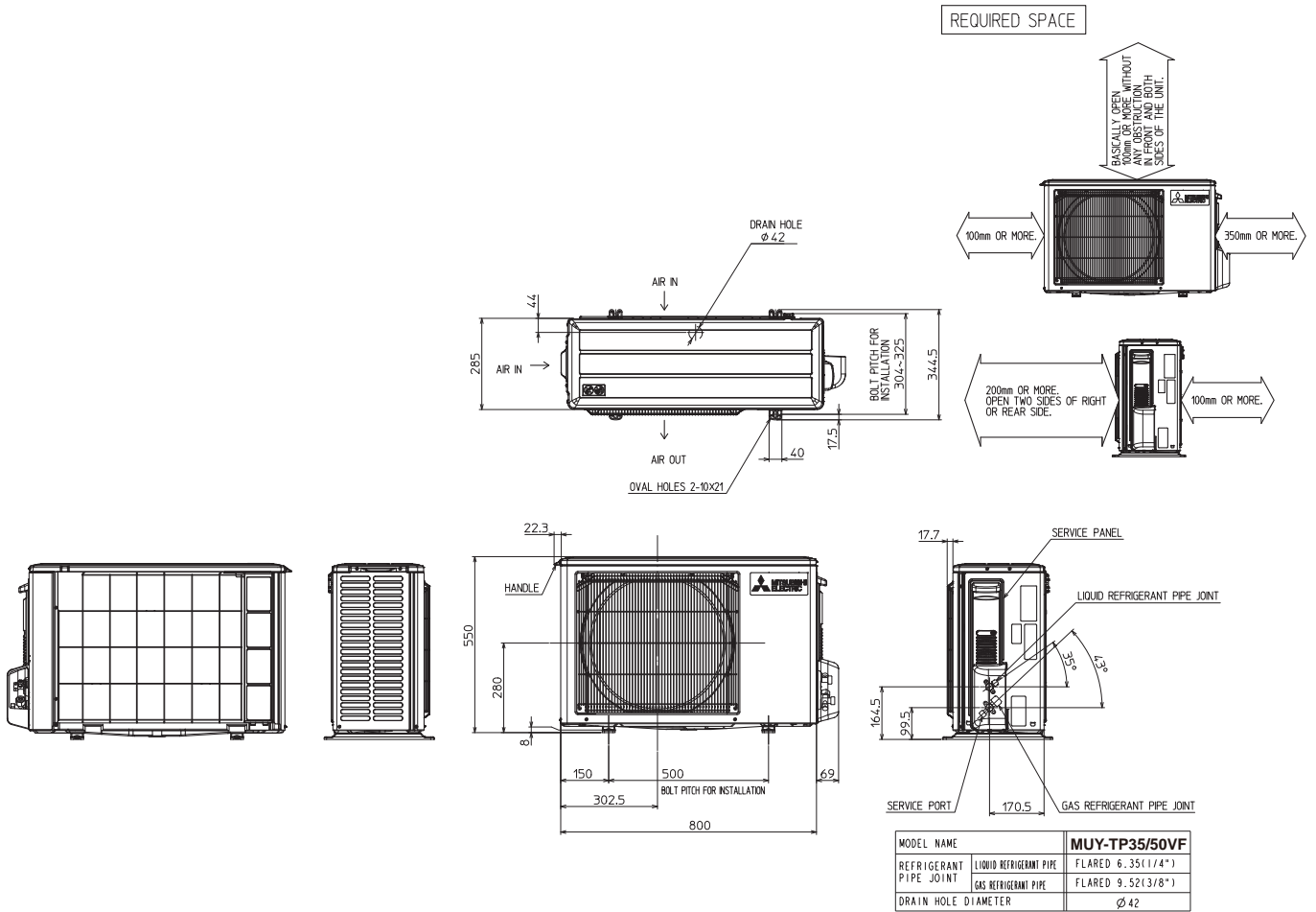

Unit: mm

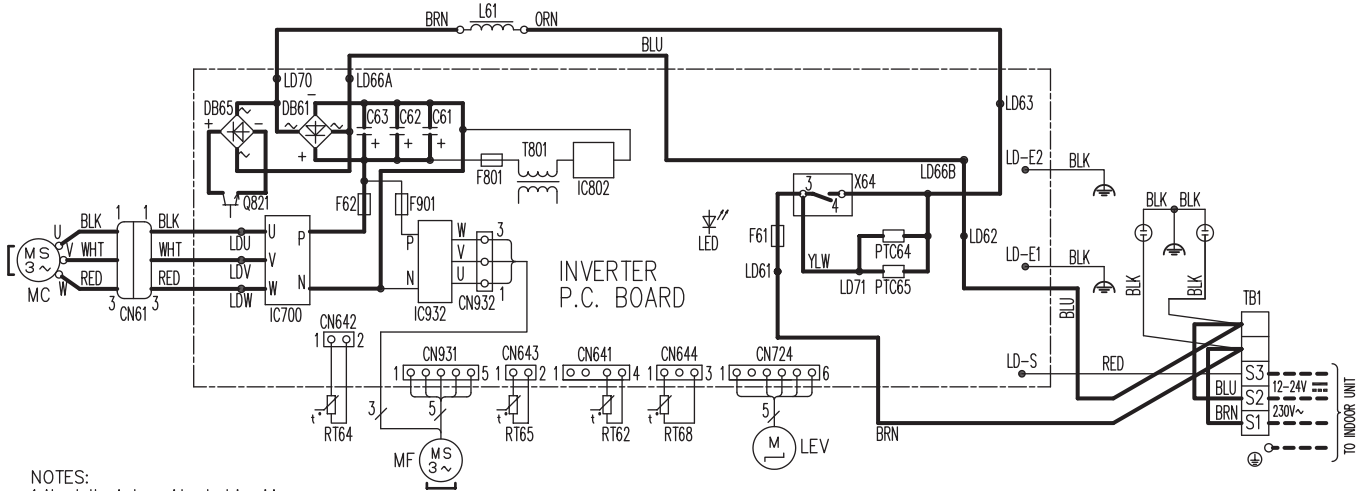

MUY-TP35VF - [E1] MUY-TP50VF - [E1]



NOTES:



1. About the indoor side electric wiring, refer to the indoor unit electric wiring diagram for servicing.
2. Use copper supply wires.
3. Symbols indicate,  : Terminal block
 : Connector

SYMBOL	NAME	SYMBOL	NAME	SYMBOL	NAME
CN61	CONNECTOR	LED	LED	RT64	FIN TEMP. THERMISTOR
C61, C62, C63	SMOOTHING CAPACITOR	LEV	EXPANSION VALVE COIL	RT65	AMBIENT TEMP. THERMISTOR
DB61, DB65	DIODE MODULE	L61	REACTOR	RT68	OUTDOOR HEAT EXCHANGER TEMP. THERMISTOR
F61	FUSE (25A 250V)	MC	COMPRESSOR	TB1	TERMINAL BLOCK
F62	FUSE (15A 250V)	MF	FAN MOTOR	T801	TRANSFORMER
F801, F901	FUSE (T3.15A/250V)	PTC64, PTC65	CIRCUIT PROTECTION	X64	RELAY
IC700, IC932	POWER MODULE	Q821	SWITCHING POWER TRANSISTOR		
IC802	POWER DEVICE	RT62	DISCHARGE TEMP. THERMISTOR		

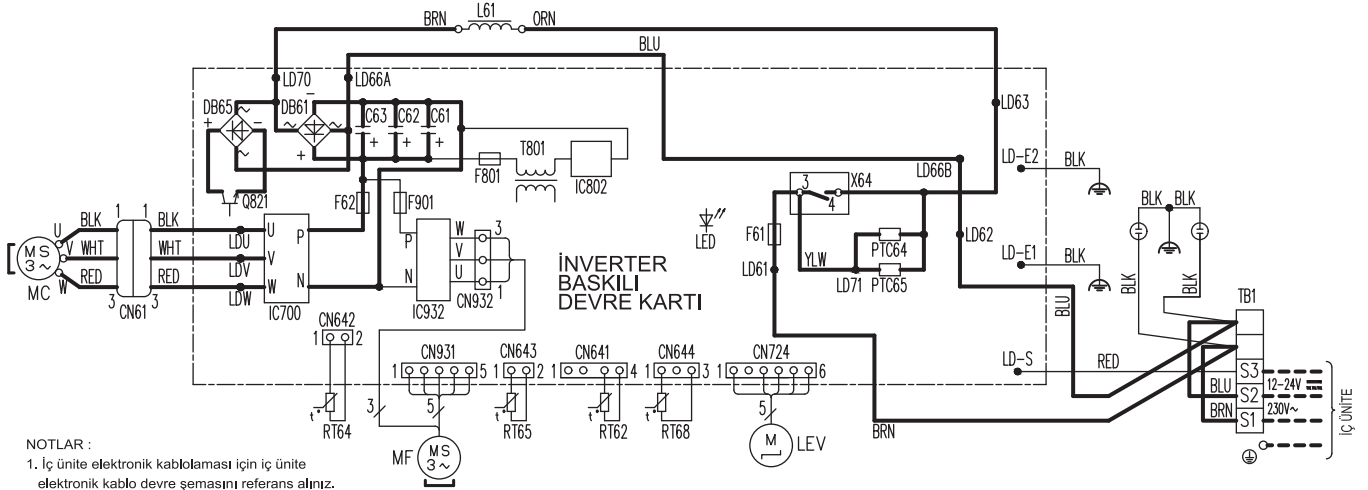
MUY-TP35VF - [ET1] MUY-TP50VF - [ET1]



NOTLAR :

1. İç ünite elektronik kablolması için iç ünite elektronik kablo devre şemasını referans alınız.
2. Sadece bakır besleme kablosu kullanınız.
3. Sembollerini gösterir,  : Terminal blok
 : Konnektör

SEMBOL	PARÇA ADI	SEMBOL	PARÇA ADI	SEMBOL	PARÇA ADI
CN61	KONNEKTÖR	LEV	GENLEŞME VANASI SARGISI	RT68	DIŞ ÜNİTE EŞANJÖR SICAKLIK TERMİSTÖRÜ
C61, C62, C63	KAPASİTÖR	L61	REAKTÖR	TB1	TERMİNAL BLOĞU
DB61, DB65	DIYOT MODÜLÜ	MC	KOMPRESÖR	T801	TRANSFORMATÖR
F61	SİGORTA (25A 250V)	MF	FAN MOTORU	X64	RÖLE
F62	SİGORTA (15A 250V)	PTC64, PTC65	DEVRE KORUMASI		
F801, F901	SİGORTA (T3. 15A/250V)	Q821	SİVİÇLİ GÜÇ TRANSİSTÖRÜ		
IC700, IC932	GÜÇ MODÜLÜ	RT62	BASMA SICAKLIK TERMİSTÖRÜ		
IC802	GÜÇ CİHAZI	RT64	FIN SICAKLIK TERMİSTÖRÜ		
LED	LED	RT65	ORTAM SICAKLIK TERMİSTÖRÜ		

8

REFRIGERANT SYSTEM DIAGRAM

MUY-TP35VF MUY-TP50VF

Unit: mm

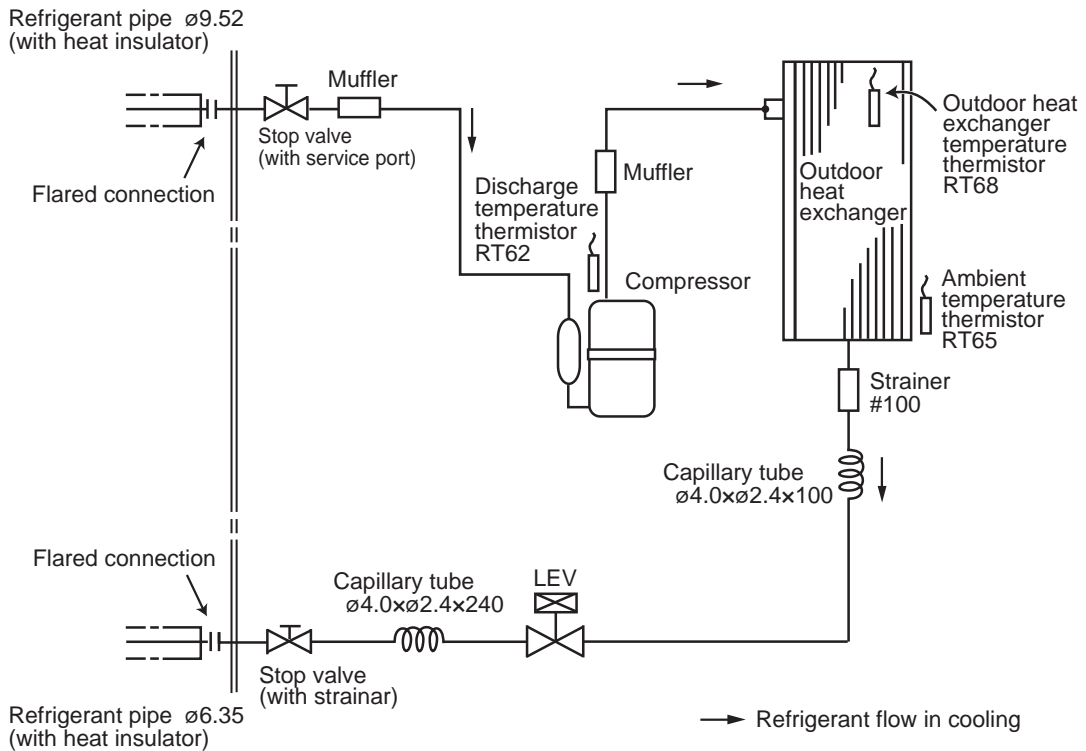

MAX. REFRIGERANT PIPING LENGTH and MAX. HEIGHT DIFFERENCE

Model	Refrigerant piping: m		Piping size O.D: mm	
	Max. Length A	Max. Height difference B	Gas	Liquid
MUY-TP35/50VF	20	12	9.52	6.35

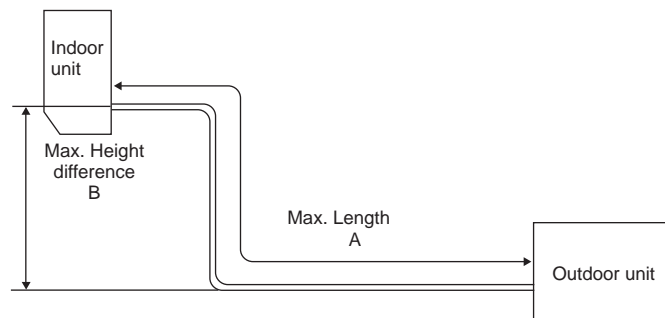

ADDITIONAL REFRIGERANT CHARGE (R32: g)

Model	Outdoor unit precharged	Refrigerant piping length (one way)									
		7 m	8 m	9 m	10 m	11 m	12 m	13 m	14 m	15 m	20 m
MUY-TP35/50VF	850	0	10	20	30	40	50	60	70	80	130

Calculation: $X \text{ g} = 10 \text{ g/m} \times (\text{Refrigerant piping length (m)} - 7)$

NOTE: Refrigerant piping exceeding 7 m requires additional refrigerant charge according to the calculation.

MUY-TP35VF MUY-TP50VF

The standard specifications apply only to the operation of the air conditioner under normal conditions. Since operating conditions vary according to the areas where these units are installed, the following information has been provided to clarify the operating characteristics of the air conditioner under the conditions indicated by the performance curve.

(1) GUARANTEED VOLTAGE

198 ~ 264 V, 50 Hz

(2) AIR FLOW

Air flow should be set at MAX.

(3) MAIN READINGS

- | | | |
|--|---------|-----------|
| (1) Indoor intake air wet-bulb temperature: | °C [WB] | } Cooling |
| (2) Indoor outlet air wet-bulb temperature: | °C [WB] | |
| (3) Outdoor intake air dry-bulb temperature: | °C [DB] | |
| (4) Total input: | W | |

Indoor air wet and dry bulb temperature difference on the left side of the following chart shows the difference between the indoor intake air wet and dry bulb temperature and the indoor outlet air wet and dry bulb temperature for your reference at service.

How to measure the indoor air wet and dry bulb temperature difference

- Attach at least 2 sets of wet and dry bulb thermometers to the indoor air intake as shown in the figure, and at least 2 sets of wet and dry bulb thermometers to the indoor air outlet. The thermometers must be attached to the position where air speed is high.
- Attach at least 2 sets of wet and dry bulb thermometers to the outdoor air intake. Cover the thermometers to prevent direct rays of the sun.
- Check that the air filter is cleaned.
- Open windows and doors of room.
- Press the EMERGENCY OPERATION switch once to start the EMERGENCY COOL MODE.
- When system stabilizes after more than 15 minutes, measure temperature and take an average temperature.
- 10 minutes later, measure temperature again and check that the temperature does not change.

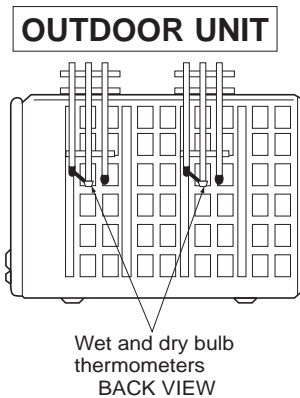
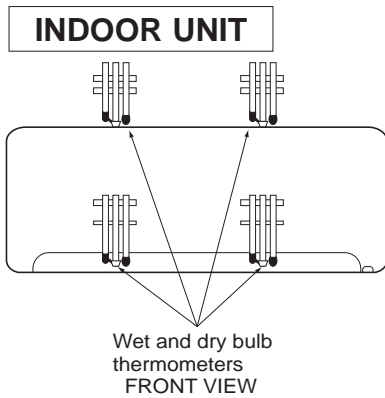

9-1. CAPACITY AND INPUT CURVES

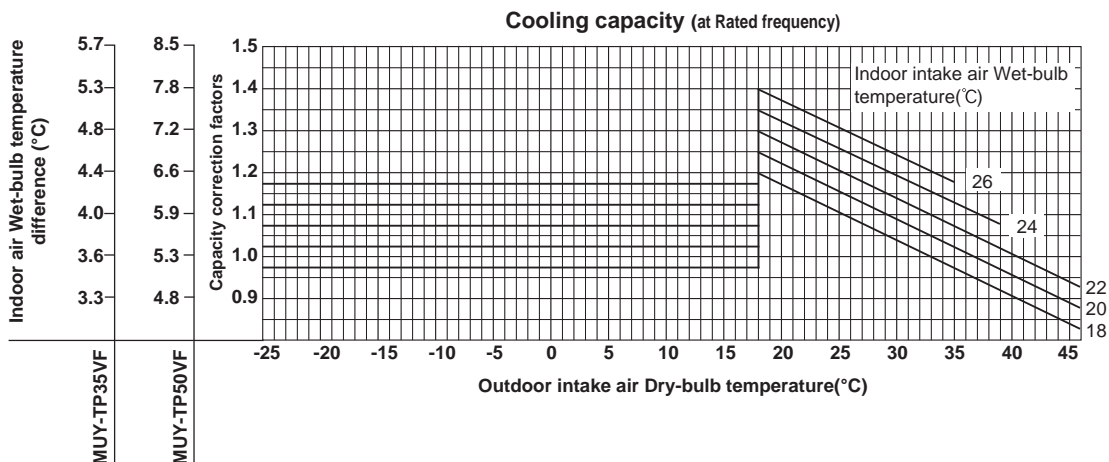

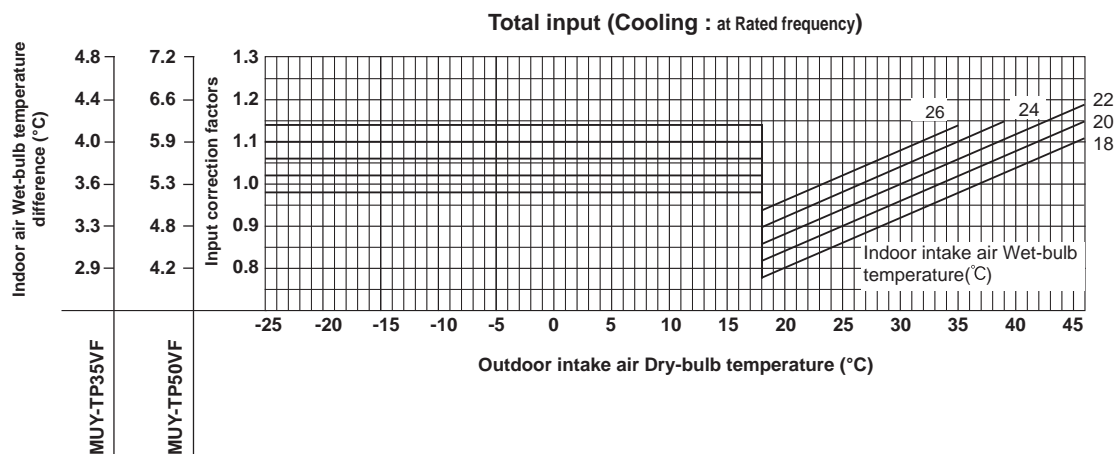
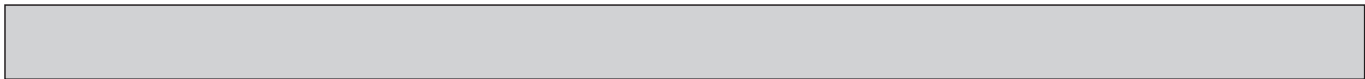

9-2. CAPACITY AND INPUT CORRECTION BY OPERATIONAL FREQUENCY OF COMPRESSOR

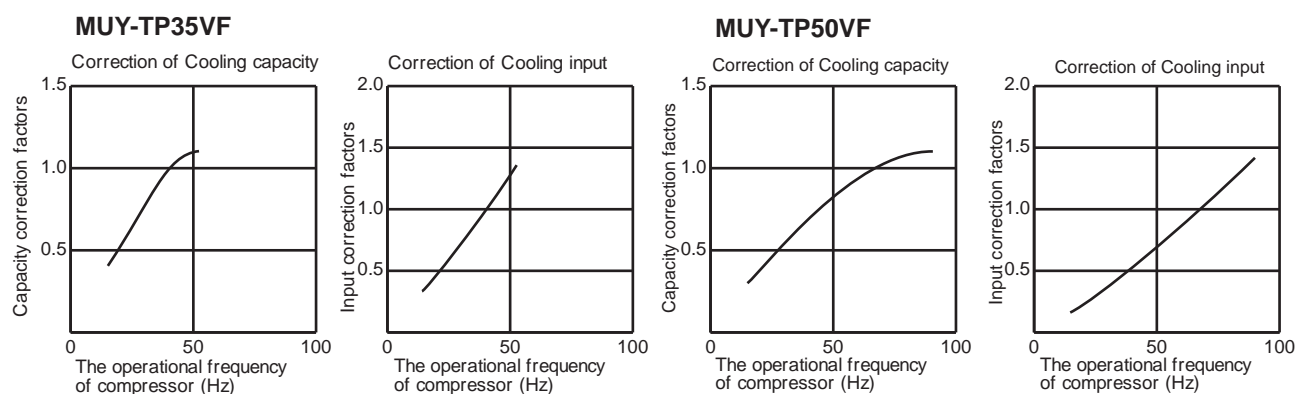

9-3. HOW TO OPERATE FIXED-FREQUENCY OPERATION

<Test run operation>

1. Press EMERGENCY OPERATION switch to start COOL mode (COOL: Press once).
2. Test run operation starts and continues to operate for 30 minutes.
3. Compressor operates at rated frequency in COOL mode.
4. Indoor fan operates at High speed.
5. After 30 minutes, test run operation finishes and EMERGENCY OPERATION starts (operation frequency of compressor varies).
6. To cancel test run operation (EMERGENCY OPERATION), press EMERGENCY OPERATION switch or any button on remote controller.

9-4. OUTDOOR LOW PRESSURE AND OUTDOOR UNIT CURRENT

COOL operation

- ① Both indoor and outdoor unit are under the same temperature/humidity condition.
- ② Operation: TEST RUN OPERATION (Refer to 9-3.)

Dry-bulb temperature (°C)	Relative humidity (%)
20	50
25	60
30	70

Outdoor low pressure

MUY-TP35VF

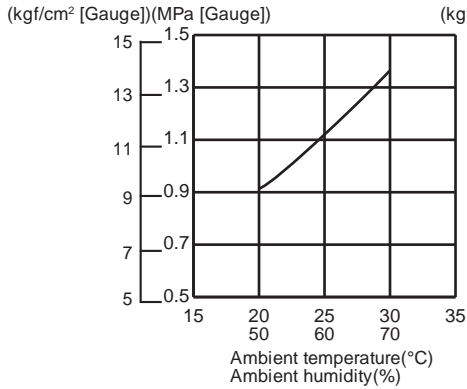

MUY-TP50VF

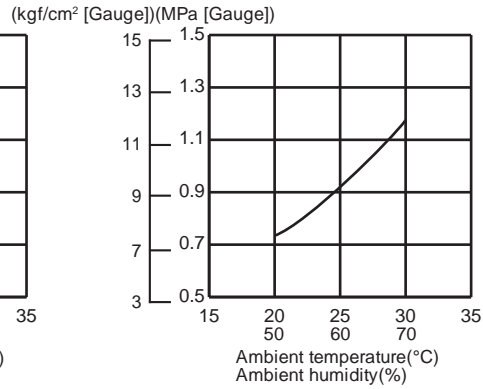

NOTE:

The unit of pressure has been changed to MPa on the international system of units (SI unit system)
 The conversion factor is: **1 (MPa [Gauge]) = 10.2 (kgf/cm² [Gauge])**

Outdoor unit current

MUY-TP35VF

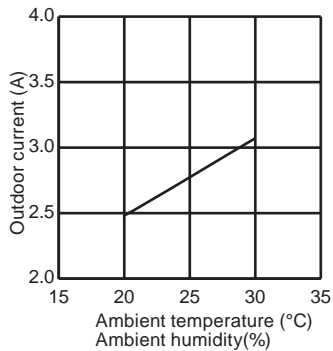

MUY-TP50VF

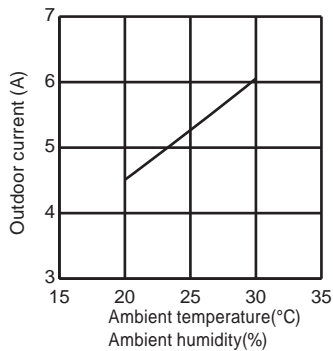

PERFORMANCE DATA COOL operation at Rated frequency
MUY-TP35VF

CAPACITY: 3.5 kW

SHF: 0.98

INPUT: 790 W

SHF: 0.9 (When Cooling capacity is 3.5 kW under our measurement condition)
 Our measurement condition: Indoor temperature 24°C
 Relative humidity 45%
 Outdoor temperature 34°C

INDOOR DB (°C)	INDOOR WB (°C)	OUTDOOR DB (°C)															
		21				25				27				30			
		Q	SHC	SHF	INPUT	Q	SHC	SHF	INPUT	Q	SHC	SHF	INPUT	Q	SHC	SHF	INPUT
21	15	3.84	3.76	0.98	584	3.65	3.57	0.98	617	3.47	3.40	0.98	643	3.32	3.25	0.98	677
21	18	4.11	3.29	0.80	632	3.94	3.15	0.80	664	3.78	3.02	0.80	695	3.64	2.91	0.80	727
21	20	4.29	2.92	0.68	664	4.11	2.80	0.68	703	3.99	2.71	0.68	719	3.85	2.62	0.68	751
22	15	3.84	3.84	1.00	584	3.65	3.65	1.00	617	3.47	3.47	1.00	643	3.32	3.32	1.00	677
22	18	4.11	3.45	0.84	632	3.94	3.31	0.84	664	3.78	3.18	0.84	695	3.64	3.06	0.84	727
22	20	4.29	3.09	0.72	664	4.11	2.96	0.72	703	3.99	2.87	0.72	719	3.85	2.77	0.72	751
22	22	4.46	2.68	0.60	687	4.31	2.58	0.60	731	4.20	2.52	0.60	751	4.03	2.42	0.60	782
23	15	3.84	3.84	1.00	584	3.65	3.65	1.00	617	3.47	3.47	1.00	643	3.32	3.32	1.00	677
23	18	4.11	3.62	0.88	632	3.94	3.47	0.88	664	3.78	3.33	0.88	695	3.64	3.20	0.88	727
23	20	4.29	3.26	0.76	664	4.11	3.13	0.76	703	3.99	3.03	0.76	719	3.85	2.93	0.76	751
23	22	4.46	2.86	0.64	687	4.31	2.76	0.64	731	4.20	2.69	0.64	751	4.03	2.58	0.64	782
24	15	3.84	3.84	1.00	584	3.65	3.65	1.00	617	3.47	3.47	1.00	643	3.32	3.32	1.00	677
24	18	4.11	3.78	0.92	632	3.94	3.62	0.92	664	3.78	3.48	0.92	695	3.64	3.35	0.92	727
24	20	4.29	3.43	0.80	664	4.11	3.29	0.80	703	3.99	3.19	0.80	719	3.85	3.08	0.80	751
24	22	4.46	3.03	0.68	687	4.31	2.93	0.68	731	4.20	2.86	0.68	751	4.03	2.74	0.68	782
24	24	4.69	2.63	0.56	719	4.52	2.53	0.56	758	4.41	2.47	0.56	782	4.27	2.39	0.56	822
25	15	3.84	3.84	1.00	584	3.65	3.65	1.00	617	3.47	3.47	1.00	643	3.32	3.32	1.00	677
25	18	4.11	3.95	0.96	632	3.94	3.78	0.96	664	3.78	3.63	0.96	695	3.64	3.49	0.96	727
25	20	4.29	3.60	0.84	664	4.11	3.45	0.84	703	3.99	3.35	0.84	719	3.85	3.23	0.84	751
25	22	4.46	3.21	0.72	687	4.31	3.10	0.72	731	4.20	3.02	0.72	751	4.03	2.90	0.72	782
25	24	4.69	2.81	0.60	719	4.52	2.71	0.60	758	4.41	2.65	0.60	782	4.27	2.56	0.60	822
26	15	3.84	3.84	1.00	584	3.65	3.65	1.00	617	3.47	3.47	1.00	643	3.32	3.32	1.00	677
26	18	4.11	4.11	1.00	632	3.94	3.94	1.00	664	3.78	3.78	1.00	695	3.64	3.64	1.00	727
26	20	4.29	3.77	0.88	664	4.11	3.62	0.88	703	3.99	3.51	0.88	719	3.85	3.39	0.88	751
26	22	4.46	3.39	0.76	687	4.31	3.27	0.76	731	4.20	3.19	0.76	751	4.03	3.06	0.76	782
26	24	4.69	3.00	0.64	719	4.52	2.89	0.64	758	4.41	2.82	0.64	782	4.27	2.73	0.64	822
26	26	4.83	2.51	0.52	758	4.69	2.44	0.52	798	4.62	2.40	0.52	822	4.48	2.33	0.52	845
27	15	3.84	3.84	1.00	584	3.65	3.65	1.00	617	3.47	3.47	1.00	643	3.32	3.32	1.00	677
27	18	4.11	4.11	1.00	632	3.94	3.94	1.00	664	3.78	3.78	1.00	695	3.64	3.64	1.00	727
27	20	4.29	3.94	0.92	664	4.11	3.78	0.92	703	3.99	3.67	0.92	719	3.85	3.54	0.92	751
27	22	4.46	3.57	0.80	687	4.31	3.44	0.80	731	4.20	3.36	0.80	751	4.03	3.22	0.80	782
27	24	4.69	3.19	0.68	719	4.52	3.07	0.68	758	4.41	3.00	0.68	782	4.27	2.90	0.68	822
27	26	4.83	2.70	0.56	758	4.69	2.63	0.56	798	4.62	2.59	0.56	822	4.48	2.51	0.56	845
28	15	3.84	3.84	1.00	584	3.65	3.65	1.00	617	3.47	3.47	1.00	643	3.32	3.32	1.00	677
28	18	4.11	4.11	1.00	632	3.94	3.94	1.00	664	3.78	3.78	1.00	695	3.64	3.64	1.00	727
28	20	4.29	4.12	0.96	664	4.11	3.95	0.96	703	3.99	3.83	0.96	719	3.85	3.70	0.96	751
28	22	4.46	3.75	0.84	687	4.31	3.62	0.84	731	4.20	3.53	0.84	751	4.03	3.38	0.84	782
28	24	4.69	3.38	0.72	719	4.52	3.25	0.72	758	4.41	3.18	0.72	782	4.27	3.07	0.72	822
28	26	4.83	2.90	0.60	758	4.69	2.81	0.60	798	4.62	2.77	0.60	822	4.48	2.69	0.60	845
29	15	3.84	3.84	1.00	584	3.65	3.65	1.00	617	3.47	3.47	1.00	643	3.32	3.32	1.00	677
29	18	4.11	4.11	1.00	632	3.94	3.94	1.00	664	3.78	3.78	1.00	695	3.64	3.64	1.00	727
29	20	4.29	4.29	1.00	664	4.11	4.11	1.00	703	3.99	3.99	1.00	719	3.85	3.85	1.00	751
29	22	4.46	3.93	0.88	687	4.31	3.79	0.88	731	4.20	3.70	0.88	751	4.03	3.54	0.88	782
29	24	4.69	3.56	0.76	719	4.52	3.43	0.76	758	4.41	3.35	0.76	782	4.27	3.25	0.76	822
29	26	4.83	3.09	0.64	758	4.69	3.00	0.64	798	4.62	2.96	0.64	822	4.48	2.87	0.64	845
30	15	3.84	3.84	1.00	584	3.65	3.65	1.00	617	3.47	3.47	1.00	643	3.32	3.32	1.00	677
30	18	4.11	4.11	1.00	632	3.94	3.94	1.00	664	3.78	3.78	1.00	695	3.64	3.64	1.00	727
30	20	4.29	4.29	1.00	664	4.11	4.11	1.00	703	3.99	3.99	1.00	719	3.85	3.85	1.00	751
30	22	4.46	4.11	0.92	687	4.31	3.96	0.92	731	4.20	3.86	0.92	751	4.03	3.70	0.92	782
30	24	4.69	3.75	0.80	719	4.52	3.61	0.80	758	4.41	3.53	0.80	782	4.27	3.42	0.80	822
30	26	4.83	3.28	0.68	758	4.69	3.19	0.68	798	4.62	3.14	0.68	822	4.48	3.05	0.68	845
31	15	3.84	3.84	1.00	584	3.65	3.65	1.00	617	3.47	3.47	1.00	643	3.32	3.32	1.00	677
31	18	4.11	4.11	1.00	632	3.94	3.94	1.00	664	3.78	3.78	1.00	695	3.64	3.64	1.00	727
31	20	4.29	4.29	1.00	664	4.11	4.11	1.00	703	3.99	3.99	1.00	719	3.85	3.85	1.00	751
31	22	4.46	4.28	0.96	687	4.31	4.13	0.96	731	4.20	4.03	0.96	751	4.03	3.86	0.96	782
31	24	4.69	3.94	0.84	719	4.52	3.79	0.84	758	4.41	3.70	0.84	782	4.27	3.59	0.84	822
31	26	4.83	3.48	0.72	758	4.69	3.38	0.72	798	4.62	3.33	0.72	822	4.48	3.23	0.72	845
32	15	3.84	3.84	1.00	584	3.65	3.65	1.00	617	3.47	3.47	1.00	643	3.32	3.32	1.00	677
32	18	4.11	4.11	1.00	632	3.94	3.94	1.00	664	3.78	3.78	1.00	695	3.64	3.64	1.00	727
32	20	4.29	4.29	1.00	664	4.11	4.11	1.00	703	3.99	3.99	1.00	719	3.85	3.85	1.00	751
32	22	4.46	4.46	1.00	687	4.31	4.31	1.00	731	4.20	4.20	1.00	751	4.03	4.03	1.00	782
32	24	4.69	4.13	0.88	719	4.52	3.97	0.88	758	4.41	3.88	0.88	782	4.27	3.76	0.88	822
32	26	4.83	3.67	0.76	758	4.69	3.56	0.76	798	4.62	3.51	0.76	822	4.48	3.40	0.76	845

NOTE Q : Total capacity (kW) SHF : Sensible heat factor DB : Dry-bulb temperature
 SHC : Sensible heat capacity (kW) INPUT : Total power input (W) WB : Wet-bulb temperature

PERFORMANCE DATA COOL operation at Rated frequency

MUY-TP35VF

CAPACITY: 3.5 kW

SHF: 0.98

INPUT: 790 W

SHF: 0.9 (When Cooling capacity is 3.5 kW under our measurement condition)

Our measurement condition: Indoor temperature 24°C

Relative humidity 45%

Outdoor temperature 34°C

INDOOR DB (°C)	INDOOR WB (°C)	OUTDOOR DB (°C)											
		35				40				46			
		Q	SHC	SHF	INPUT	Q	SHC	SHF	INPUT	Q	SHC	SHF	INPUT
21	15	3.11	3.05	0.98	727	2.84	2.78	0.98	775	2.58	2.53	0.98	810
21	18	3.43	2.74	0.80	774	3.15	2.52	0.80	822	2.91	2.32	0.80	853
21	20	3.61	2.45	0.68	806	3.36	2.28	0.68	845	3.12	2.12	0.68	893
22	15	3.11	3.11	1.00	727	2.84	2.84	1.00	775	2.58	2.58	1.00	810
22	18	3.43	2.88	0.84	774	3.15	2.65	0.84	822	2.91	2.44	0.84	853
22	20	3.61	2.60	0.72	806	3.36	2.42	0.72	845	3.12	2.24	0.72	893
22	22	3.82	2.29	0.60	837	3.57	2.14	0.60	885	3.33	2.00	0.60	916
23	15	3.11	3.11	1.00	727	2.84	2.84	1.00	775	2.58	2.58	1.00	810
23	18	3.43	3.02	0.88	774	3.15	2.77	0.88	822	2.91	2.56	0.88	853
23	20	3.61	2.74	0.76	806	3.36	2.55	0.76	845	3.12	2.37	0.76	893
23	22	3.82	2.44	0.64	837	3.57	2.28	0.64	885	3.33	2.13	0.64	916
24	15	3.11	3.11	1.00	727	2.84	2.84	1.00	775	2.58	2.58	1.00	810
24	18	3.43	3.16	0.92	774	3.15	2.90	0.92	822	2.91	2.67	0.92	853
24	20	3.61	2.88	0.80	806	3.36	2.69	0.80	845	3.12	2.49	0.80	893
24	22	3.82	2.59	0.68	837	3.57	2.43	0.68	885	3.33	2.26	0.68	916
24	24	4.03	2.25	0.56	869	3.78	2.12	0.56	909	3.57	2.00	0.56	948
25	15	3.11	3.11	1.00	727	2.84	2.84	1.00	775	2.58	2.58	1.00	810
25	18	3.43	3.29	0.96	774	3.15	3.02	0.96	822	2.91	2.79	0.96	853
25	20	3.61	3.03	0.84	806	3.36	2.82	0.84	845	3.12	2.62	0.84	893
25	22	3.82	2.75	0.72	837	3.57	2.57	0.72	885	3.33	2.39	0.72	916
25	24	4.03	2.42	0.60	869	3.78	2.27	0.60	909	3.57	2.14	0.60	948
26	15	3.11	3.11	1.00	727	2.84	2.84	1.00	775	2.58	2.58	1.00	810
26	18	3.43	3.43	1.00	774	3.15	3.15	1.00	822	2.91	2.91	1.00	853
26	20	3.61	3.17	0.88	806	3.36	2.96	0.88	845	3.12	2.74	0.88	893
26	22	3.82	2.90	0.76	837	3.57	2.71	0.76	885	3.33	2.53	0.76	916
26	24	4.03	2.58	0.64	869	3.78	2.42	0.64	909	3.57	2.28	0.64	948
26	26	4.24	2.20	0.52	901	3.99	2.07	0.52	940	3.75	1.95	0.52	980
27	15	3.11	3.11	1.00	727	2.84	2.84	1.00	775	2.58	2.58	1.00	810
27	18	3.43	3.43	1.00	774	3.15	3.15	1.00	822	2.91	2.91	1.00	853
27	20	3.61	3.32	0.92	806	3.36	3.09	0.92	845	3.12	2.87	0.92	893
27	22	3.82	3.05	0.80	837	3.57	2.86	0.80	885	3.33	2.66	0.80	916
27	24	4.03	2.74	0.68	869	3.78	2.57	0.68	909	3.57	2.43	0.68	948
27	26	4.24	2.37	0.56	901	3.99	2.23	0.56	940	3.75	2.10	0.56	980
28	15	3.11	3.11	1.00	727	2.84	2.84	1.00	775	2.58	2.58	1.00	810
28	18	3.43	3.43	1.00	774	3.15	3.15	1.00	822	2.91	2.91	1.00	853
28	20	3.61	3.46	0.96	806	3.36	3.23	0.96	845	3.12	2.99	0.96	893
28	22	3.82	3.20	0.84	837	3.57	3.00	0.84	885	3.33	2.79	0.84	916
28	24	4.03	2.90	0.72	869	3.78	2.72	0.72	909	3.57	2.57	0.72	948
28	26	4.24	2.54	0.60	901	3.99	2.39	0.60	940	3.75	2.25	0.60	980
29	15	3.11	3.11	1.00	727	2.84	2.84	1.00	775	2.58	2.58	1.00	810
29	18	3.43	3.43	1.00	774	3.15	3.15	1.00	822	2.91	2.91	1.00	853
29	20	3.61	3.61	1.00	806	3.36	3.36	1.00	845	3.12	3.12	1.00	893
29	22	3.82	3.36	0.88	837	3.57	3.14	0.88	885	3.33	2.93	0.88	916
29	24	4.03	3.06	0.76	869	3.78	2.87	0.76	909	3.57	2.71	0.76	948
29	26	4.24	2.71	0.64	901	3.99	2.55	0.64	940	3.75	2.40	0.64	980
30	15	3.11	3.11	1.00	727	2.84	2.84	1.00	775	2.58	2.58	1.00	810
30	18	3.43	3.43	1.00	774	3.15	3.15	1.00	822	2.91	2.91	1.00	853
30	20	3.61	3.61	1.00	806	3.36	3.36	1.00	845	3.12	3.12	1.00	893
30	22	3.82	3.51	0.92	837	3.57	3.28	0.92	885	3.33	3.06	0.92	916
30	24	4.03	3.22	0.80	869	3.78	3.02	0.80	909	3.57	2.86	0.80	948
30	26	4.24	2.88	0.68	901	3.99	2.71	0.68	940	3.75	2.55	0.68	980
31	15	3.11	3.11	1.00	727	2.84	2.84	1.00	775	2.58	2.58	1.00	810
31	18	3.43	3.43	1.00	774	3.15	3.15	1.00	822	2.91	2.91	1.00	853
31	20	3.61	3.61	1.00	806	3.36	3.36	1.00	845	3.12	3.12	1.00	893
31	22	3.82	3.66	0.96	837	3.57	3.43	0.96	885	3.33	3.19	0.96	916
31	24	4.03	3.38	0.84	869	3.78	3.18	0.84	909	3.57	3.00	0.84	948
31	26	4.24	3.05	0.72	901	3.99	2.87	0.72	940	3.75	2.70	0.72	980
32	15	3.11	3.11	1.00	727	2.84	2.84	1.00	775	2.58	2.58	1.00	810
32	18	3.43	3.43	1.00	774	3.15	3.15	1.00	822	2.91	2.91	1.00	853
32	20	3.61	3.61	1.00	806	3.36	3.36	1.00	845	3.12	3.12	1.00	893
32	22	3.82	3.82	1.00	837	3.57	3.57	1.00	885	3.33	3.33	1.00	916
32	24	4.03	3.54	0.88	869	3.78	3.33	0.88	909	3.57	3.14	0.88	948
32	26	4.24	3.22	0.76	901	3.99	3.03	0.76	940	3.75	2.85	0.76	980

NOTE Q : Total capacity (kW) SHF : Sensible heat factor DB : Dry-bulb temperature
 SHC : Sensible heat capacity (kW) INPUT : Total power input (W) WB : Wet-bulb temperature

PERFORMANCE DATA COOL operation at Rated frequency

MUY-TP50VF

CAPACITY: 5.0 kW

SHF: 0.82

INPUT: 1460 W

SHF: 0.87 (When Cooling capacity is 5.0 kW under our measurement condition)

Our measurement condition: Indoor temperature 24°C

Relative humidity 45%

Outdoor temperature 34°C

INDOOR DB (°C)	INDOOR WB (°C)	OUTDOOR DB (°C)															
		21				25				27				30			
		Q	SHC	SHF	INPUT	Q	SHC	SHF	INPUT	Q	SHC	SHF	INPUT	Q	SHC	SHF	INPUT
21	15	5.48	4.49	0.82	1080	5.21	4.27	0.82	1141	4.95	4.06	0.82	1188	4.74	3.89	0.82	1252
21	18	5.88	3.76	0.64	1168	5.63	3.60	0.64	1226	5.40	3.46	0.64	1285	5.20	3.33	0.64	1343
21	20	6.13	3.19	0.52	1226	5.88	3.06	0.52	1299	5.70	2.96	0.52	1329	5.50	2.86	0.52	1387
22	15	5.48	4.71	0.86	1080	5.21	4.48	0.86	1141	4.95	4.26	0.86	1188	4.74	4.08	0.86	1252
22	18	5.88	4.00	0.68	1168	5.63	3.83	0.68	1226	5.40	3.67	0.68	1285	5.20	3.54	0.68	1343
22	20	6.13	3.43	0.56	1226	5.88	3.29	0.56	1299	5.70	3.19	0.56	1329	5.50	3.08	0.56	1387
22	22	6.38	2.81	0.44	1270	6.15	2.71	0.44	1351	6.00	2.64	0.44	1387	5.75	2.53	0.44	1445
23	15	5.48	4.93	0.90	1080	5.21	4.69	0.90	1141	4.95	4.46	0.90	1188	4.74	4.27	0.90	1252
23	18	5.88	4.23	0.72	1168	5.63	4.05	0.72	1226	5.40	3.89	0.72	1285	5.20	3.74	0.72	1343
23	20	6.13	3.68	0.60	1226	5.88	3.53	0.60	1299	5.70	3.42	0.60	1329	5.50	3.30	0.60	1387
23	22	6.38	3.06	0.48	1270	6.15	2.95	0.48	1351	6.00	2.88	0.48	1387	5.75	2.76	0.48	1445
24	15	5.48	5.15	0.94	1080	5.21	4.90	0.94	1141	4.95	4.65	0.94	1188	4.74	4.46	0.94	1252
24	18	5.88	4.47	0.76	1168	5.63	4.28	0.76	1226	5.40	4.10	0.76	1285	5.20	3.95	0.76	1343
24	20	6.13	3.92	0.64	1226	5.88	3.76	0.64	1299	5.70	3.65	0.64	1329	5.50	3.52	0.64	1387
24	22	6.38	3.32	0.52	1270	6.15	3.20	0.52	1351	6.00	3.12	0.52	1387	5.75	2.99	0.52	1445
24	24	6.70	2.68	0.40	1329	6.45	2.58	0.40	1402	6.30	2.52	0.40	1445	6.10	2.44	0.40	1518
25	15	5.48	5.37	0.98	1080	5.21	5.11	0.98	1141	4.95	4.85	0.98	1188	4.74	4.65	0.98	1252
25	18	5.88	4.70	0.80	1168	5.63	4.50	0.80	1226	5.40	4.32	0.80	1285	5.20	4.16	0.80	1343
25	20	6.13	4.17	0.68	1226	5.88	4.00	0.68	1299	5.70	3.88	0.68	1329	5.50	3.74	0.68	1387
25	22	6.38	3.57	0.56	1270	6.15	3.44	0.56	1351	6.00	3.36	0.56	1387	5.75	3.22	0.56	1445
25	24	6.70	2.95	0.44	1329	6.45	2.84	0.44	1402	6.30	2.77	0.44	1445	6.10	2.68	0.44	1518
26	15	5.48	5.48	1.00	1080	5.21	5.21	1.00	1141	4.95	4.95	1.00	1188	4.74	4.74	1.00	1252
26	18	5.88	4.94	0.84	1168	5.63	4.73	0.84	1226	5.40	4.54	0.84	1285	5.20	4.37	0.84	1343
26	20	6.13	4.41	0.72	1226	5.88	4.23	0.72	1299	5.70	4.10	0.72	1329	5.50	3.96	0.72	1387
26	22	6.38	3.83	0.60	1270	6.15	3.69	0.60	1351	6.00	3.60	0.60	1387	5.75	3.45	0.60	1445
26	24	6.70	3.22	0.48	1329	6.45	3.10	0.48	1402	6.30	3.02	0.48	1445	6.10	2.93	0.48	1518
26	26	6.90	2.48	0.36	1402	6.70	2.41	0.36	1475	6.60	2.38	0.36	1518	6.40	2.30	0.36	1562
27	15	5.48	5.48	1.00	1080	5.21	5.21	1.00	1141	4.95	4.95	1.00	1188	4.74	4.74	1.00	1252
27	18	5.88	5.17	0.88	1168	5.63	4.95	0.88	1226	5.40	4.75	0.88	1285	5.20	4.58	0.88	1343
27	20	6.13	4.66	0.76	1226	5.88	4.47	0.76	1299	5.70	4.33	0.76	1329	5.50	4.18	0.76	1387
27	22	6.38	4.08	0.64	1270	6.15	3.94	0.64	1351	6.00	3.84	0.64	1387	5.75	3.68	0.64	1445
27	24	6.70	3.48	0.52	1329	6.45	3.35	0.52	1402	6.30	3.28	0.52	1445	6.10	3.17	0.52	1518
27	26	6.90	2.76	0.40	1402	6.70	2.68	0.40	1475	6.60	2.64	0.40	1518	6.40	2.56	0.40	1562
28	15	5.48	5.48	1.00	1080	5.21	5.21	1.00	1141	4.95	4.95	1.00	1188	4.74	4.74	1.00	1252
28	18	5.88	5.41	0.92	1168	5.63	5.18	0.92	1226	5.40	4.97	0.92	1285	5.20	4.78	0.92	1343
28	20	6.13	4.90	0.80	1226	5.88	4.70	0.80	1299	5.70	4.56	0.80	1329	5.50	4.40	0.80	1387
28	22	6.38	4.34	0.68	1270	6.15	4.18	0.68	1351	6.00	4.08	0.68	1387	5.75	3.91	0.68	1445
28	24	6.70	3.75	0.56	1329	6.45	3.61	0.56	1402	6.30	3.53	0.56	1445	6.10	3.42	0.56	1518
28	26	6.90	3.04	0.44	1402	6.70	2.95	0.44	1475	6.60	2.90	0.44	1518	6.40	2.82	0.44	1562
29	15	5.48	5.48	1.00	1080	5.21	5.21	1.00	1141	4.95	4.95	1.00	1188	4.74	4.74	1.00	1252
29	18	5.88	5.64	0.96	1168	5.63	5.40	0.96	1226	5.40	5.18	0.96	1285	5.20	4.99	0.96	1343
29	20	6.13	5.15	0.84	1226	5.88	4.94	0.84	1299	5.70	4.79	0.84	1329	5.50	4.62	0.84	1387
29	22	6.38	4.59	0.72	1270	6.15	4.43	0.72	1351	6.00	4.32	0.72	1387	5.75	4.14	0.72	1445
29	24	6.70	4.02	0.60	1329	6.45	3.87	0.60	1402	6.30	3.78	0.60	1445	6.10	3.66	0.60	1518
29	26	6.90	3.31	0.48	1402	6.70	3.22	0.48	1475	6.60	3.17	0.48	1518	6.40	3.07	0.48	1562
30	15	5.48	5.48	1.00	1080	5.21	5.21	1.00	1141	4.95	4.95	1.00	1188	4.74	4.74	1.00	1252
30	18	5.88	5.88	1.00	1168	5.63	5.63	1.00	1226	5.40	5.40	1.00	1285	5.20	5.20	1.00	1343
30	20	6.13	5.39	0.88	1226	5.88	5.17	0.88	1299	5.70	5.02	0.88	1329	5.50	4.84	0.88	1387
30	22	6.38	4.85	0.76	1270	6.15	4.67	0.76	1351	6.00	4.56	0.76	1387	5.75	4.37	0.76	1445
30	24	6.70	4.29	0.64	1329	6.45	4.13	0.64	1402	6.30	4.03	0.64	1445	6.10	3.90	0.64	1518
30	26	6.90	3.59	0.52	1402	6.70	3.48	0.52	1475	6.60	3.43	0.52	1518	6.40	3.33	0.52	1562
31	15	5.48	5.48	1.00	1080	5.21	5.21	1.00	1141	4.95	4.95	1.00	1188	4.74	4.74	1.00	1252
31	18	5.88	5.88	1.00	1168	5.63	5.63	1.00	1226	5.40	5.40	1.00	1285	5.20	5.20	1.00	1343
31	20	6.13	5.64	0.92	1226	5.88	5.41	0.92	1299	5.70	5.24	0.92	1329	5.50	5.06	0.92	1387
31	22	6.38	5.10	0.80	1270	6.15	4.92	0.80	1351	6.00	4.80	0.80	1387	5.75	4.60	0.80	1445
31	24	6.70	4.56	0.68	1329	6.45	4.39	0.68	1402	6.30	4.28	0.68	1445	6.10	4.15	0.68	1518
31	26	6.90	3.86	0.56	1402	6.70	3.75	0.56	1475	6.60	3.70	0.56	1518	6.40	3.58	0.56	1562
32	15	5.48	5.48	1.00	1080	5.21	5.21	1.00	1141	4.95	4.95	1.00	1188	4.74	4.74	1.00	1252
32	18	5.88	5.88	1.00	1168	5.63	5.63	1.00	1226	5.40	5.40	1.00	1285	5.20	5.20	1.00	1343
32	20	6.13	5.88	0.96	1226	5.88	5.64	0.96	1299	5.70	5.47	0.96	1329	5.50	5.28	0.96	1387
32	22	6.38	5.36	0.84	1270	6.15	5.17	0.84	1351	6.00	5.04	0.84	1387	5.75	4.83	0.84	1445
32	24	6.70	4.82	0.72	1329	6.45	4.64	0.72	1402	6.30	4.54	0.72	1445	6.10	4.39	0.72	1518
32	26	6.90	4.14	0.60	1402	6.70	4.02	0.60	1475	6.60	3.96	0.60	1518	6.40	3.84	0.60	1562

NOTE Q : Total capacity (kW) SHF : Sensible heat factor DB : Dry-bulb temperature
 SHC : Sensible heat capacity (kW) INPUT : Total power input (W) WB : Wet-bulb temperature

PERFORMANCE DATA COOL operation at Rated frequency

MUY-TP50VF

CAPACITY: 5.0 kW

SHF: 0.82

INPUT: 1460 W

SHF: 0.87 (When Cooling capacity is 5.0 kW under our measurement condition)

Our measurement condition: Indoor temperature 24°C

Relative humidity 45%

Outdoor temperature 34°C

INDOOR DB (°C)	INDOOR WB (°C)	OUTDOOR DB (°C)											
		35				40				46			
		Q	SHC	SHF	INPUT	Q	SHC	SHF	INPUT	Q	SHC	SHF	INPUT
21	15	4.45	3.64	0.82	1343	4.05	3.32	0.82	1432	3.69	3.03	0.82	1497
21	18	4.90	3.14	0.64	1431	4.50	2.88	0.64	1518	4.15	2.66	0.64	1577
21	20	5.15	2.68	0.52	1489	4.80	2.50	0.52	1562	4.45	2.31	0.52	1650
22	15	4.45	3.82	0.86	1343	4.05	3.48	0.86	1432	3.69	3.18	0.86	1497
22	18	4.90	3.33	0.68	1431	4.50	3.06	0.68	1518	4.15	2.82	0.68	1577
22	20	5.15	2.88	0.56	1489	4.80	2.69	0.56	1562	4.45	2.49	0.56	1650
22	22	5.45	2.40	0.44	1548	5.10	2.24	0.44	1635	4.75	2.09	0.44	1694
23	15	4.45	4.00	0.90	1343	4.05	3.65	0.90	1432	3.69	3.32	0.90	1497
23	18	4.90	3.53	0.72	1431	4.50	3.24	0.72	1518	4.15	2.99	0.72	1577
23	20	5.15	3.09	0.60	1489	4.80	2.88	0.60	1562	4.45	2.67	0.60	1650
23	22	5.45	2.62	0.48	1548	5.10	2.45	0.48	1635	4.75	2.28	0.48	1694
24	15	4.45	4.18	0.94	1343	4.05	3.81	0.94	1432	3.69	3.47	0.94	1497
24	18	4.90	3.72	0.76	1431	4.50	3.42	0.76	1518	4.15	3.15	0.76	1577
24	20	5.15	3.30	0.64	1489	4.80	3.07	0.64	1562	4.45	2.85	0.64	1650
24	22	5.45	2.83	0.52	1548	5.10	2.65	0.52	1635	4.75	2.47	0.52	1694
24	24	5.75	2.30	0.40	1606	5.40	2.16	0.40	1679	5.10	2.04	0.40	1752
25	15	4.45	4.36	0.98	1343	4.05	3.97	0.98	1432	3.69	3.62	0.98	1497
25	18	4.90	3.92	0.80	1431	4.50	3.60	0.80	1518	4.15	3.32	0.80	1577
25	20	5.15	3.50	0.68	1489	4.80	3.26	0.68	1562	4.45	3.03	0.68	1650
25	22	5.45	3.05	0.56	1548	5.10	2.86	0.56	1635	4.75	2.66	0.56	1694
25	24	5.75	2.53	0.44	1606	5.40	2.38	0.44	1679	5.10	2.24	0.44	1752
26	15	4.45	4.45	1.00	1343	4.05	4.05	1.00	1432	3.69	3.69	1.00	1497
26	18	4.90	4.12	0.84	1431	4.50	3.78	0.84	1518	4.15	3.49	0.84	1577
26	20	5.15	3.71	0.72	1489	4.80	3.46	0.72	1562	4.45	3.20	0.72	1650
26	22	5.45	3.27	0.60	1548	5.10	3.06	0.60	1635	4.75	2.85	0.60	1694
26	24	5.75	2.76	0.48	1606	5.40	2.59	0.48	1679	5.10	2.45	0.48	1752
26	26	6.05	2.18	0.36	1664	5.70	2.05	0.36	1737	5.35	1.93	0.36	1810
27	15	4.45	4.45	1.00	1343	4.05	4.05	1.00	1432	3.69	3.69	1.00	1497
27	18	4.90	4.31	0.88	1431	4.50	3.96	0.88	1518	4.15	3.65	0.88	1577
27	20	5.15	3.91	0.76	1489	4.80	3.65	0.76	1562	4.45	3.38	0.76	1650
27	22	5.45	3.49	0.64	1548	5.10	3.26	0.64	1635	4.75	3.04	0.64	1694
27	24	5.75	2.99	0.52	1606	5.40	2.81	0.52	1679	5.10	2.65	0.52	1752
27	26	6.05	2.42	0.40	1664	5.70	2.28	0.40	1737	5.35	2.14	0.40	1810
28	15	4.45	4.45	1.00	1343	4.05	4.05	1.00	1432	3.69	3.69	1.00	1497
28	18	4.90	4.51	0.92	1431	4.50	4.14	0.92	1518	4.15	3.82	0.92	1577
28	20	5.15	4.12	0.80	1489	4.80	3.84	0.80	1562	4.45	3.56	0.80	1650
28	22	5.45	3.71	0.68	1548	5.10	3.47	0.68	1635	4.75	3.23	0.68	1694
28	24	5.75	3.22	0.56	1606	5.40	3.02	0.56	1679	5.10	2.86	0.56	1752
28	26	6.05	2.66	0.44	1664	5.70	2.51	0.44	1737	5.35	2.35	0.44	1810
29	15	4.45	4.45	1.00	1343	4.05	4.05	1.00	1432	3.69	3.69	1.00	1497
29	18	4.90	4.70	0.96	1431	4.50	4.32	0.96	1518	4.15	3.98	0.96	1577
29	20	5.15	4.33	0.84	1489	4.80	4.03	0.84	1562	4.45	3.74	0.84	1650
29	22	5.45	3.92	0.72	1548	5.10	3.67	0.72	1635	4.75	3.42	0.72	1694
29	24	5.75	3.45	0.60	1606	5.40	3.24	0.60	1679	5.10	3.06	0.60	1752
29	26	6.05	2.90	0.48	1664	5.70	2.74	0.48	1737	5.35	2.57	0.48	1810
30	15	4.45	4.45	1.00	1343	4.05	4.05	1.00	1432	3.69	3.69	1.00	1497
30	18	4.90	4.90	1.00	1431	4.50	4.50	1.00	1518	4.15	4.15	1.00	1577
30	20	5.15	4.53	0.88	1489	4.80	4.22	0.88	1562	4.45	3.92	0.88	1650
30	22	5.45	4.14	0.76	1548	5.10	3.88	0.76	1635	4.75	3.61	0.76	1694
30	24	5.75	3.68	0.64	1606	5.40	3.46	0.64	1679	5.10	3.26	0.64	1752
30	26	6.05	3.15	0.52	1664	5.70	2.96	0.52	1737	5.35	2.78	0.52	1810
31	15	4.45	4.45	1.00	1343	4.05	4.05	1.00	1432	3.69	3.69	1.00	1497
31	18	4.90	4.90	1.00	1431	4.50	4.50	1.00	1518	4.15	4.15	1.00	1577
31	20	5.15	4.74	0.92	1489	4.80	4.42	0.92	1562	4.45	4.09	0.92	1650
31	22	5.45	4.36	0.80	1548	5.10	4.08	0.80	1635	4.75	3.80	0.80	1694
31	24	5.75	3.91	0.68	1606	5.40	3.67	0.68	1679	5.10	3.47	0.68	1752
31	26	6.05	3.39	0.56	1664	5.70	3.19	0.56	1737	5.35	3.00	0.56	1810
32	15	4.45	4.45	1.00	1343	4.05	4.05	1.00	1432	3.69	3.69	1.00	1497
32	18	4.90	4.90	1.00	1431	4.50	4.50	1.00	1518	4.15	4.15	1.00	1577
32	20	5.15	4.94	0.96	1489	4.80	4.61	0.96	1562	4.45	4.27	0.96	1650
32	22	5.45	4.58	0.84	1548	5.10	4.28	0.84	1635	4.75	3.99	0.84	1694
32	24	5.75	4.14	0.72	1606	5.40	3.89	0.72	1679	5.10	3.67	0.72	1752
32	26	6.05	3.63	0.60	1664	5.70	3.42	0.60	1737	5.35	3.21	0.60	1810

NOTE Q : Total capacity (kW) SHF : Sensible heat factor DB : Dry-bulb temperature
 SHC : Sensible heat capacity (kW) INPUT : Total power input (W) WB : Wet-bulb temperature

10

ACTUATOR CONTROL

MUY-TP35VF MUY-TP50VF

10-1. OUTDOOR FAN MOTOR CONTROL

The fan motor turns ON/OFF, interlocking with the compressor.

[ON] The fan motor turns ON 5 seconds before the compressor starts up.

[OFF] The fan motor turns OFF 15 seconds after the compressor has stopped running.

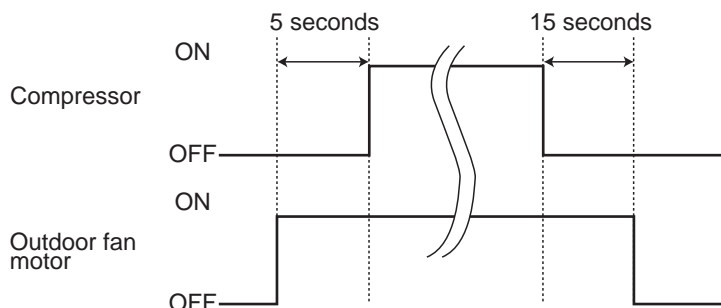

10-2. RELATION BETWEEN MAIN SENSOR AND ACTUATOR

Sensor	Purpose	Actuator		
		Compressor	LEV	Outdoor fan motor
Discharge temperature thermistor	Protection	○	○	
Indoor coil temperature thermistor	Cooling: Coil frost prevention	○		
Fin temperature thermistor	Protection	○		○
Ambient temperature thermistor	Cooling: Low ambient temperature operation	○	○	○
Outdoor heat exchanger temperature thermistor	Cooling: Low ambient temperature operation	○	○	○
	Cooling: High pressure protection	○	○	○

MUY-TP35VF MUY-TP50VF**11-1. CAUTIONS ON TROUBLESHOOTING****1. Before troubleshooting, check the following**

- 1) Check the power supply voltage.
- 2) Check the indoor/outdoor connecting wire for miswiring.

2. Take care of the following during servicing

- 1) Before servicing the air conditioner, be sure to turn OFF the main unit first with the remote controller, and then after confirming the horizontal vane is closed, turn OFF the breaker and/or disconnect the power plug.
- 2) Be sure to turn OFF the power supply before removing the front panel, the cabinet, the top panel, and the electronic control P.C. board.
- 3) When removing the electrical parts, be careful of the residual voltage of smoothing capacitor.
- 4) When removing the electronic control P.C. board, hold the edge of the board with care NOT to apply stress on the components.
- 5) When connecting or disconnecting the connectors, hold the connector housing. DO NOT pull the lead wires.

<Incorrect>

**Lead wiring**

<Correct>

**Connector housing****3. Troubleshooting procedure**

- 1) Check if the OPERATION INDICATOR lamp on the indoor unit is blinking on and off to indicate an abnormality.
To make sure, check how many times the OPERATION INDICATOR lamp is blinking on and off before starting service work.
- 2) Before servicing, check that the connector and terminal are connected properly.
- 3) When the electronic control P.C. board seems to be defective, check the copper foil pattern for disconnection and the components for bursting and discoloration.
- 4) Refer to 11-2 and 11-3.

11-2. FAILURE MODE RECALL FUNCTION

Outline of the function

This air conditioner can memorize the abnormal condition which has occurred once.

Even though LED indication listed on the troubleshooting check table (11-3.) disappears, the memorized failure details can be recalled.

This mode is very useful when the unit needs to be repaired for the abnormality which does not recur.

1. Flow chart of failure mode recall function for the indoor/outdoor unit

NOTE: Use the wireless remote controller of MSZ-HJ25VA-**E2** (Refer to parts catalog OBB647.).

The remote controller has the indication of "HEAT" and a button for it, but HEAT mode cannot be used since MSY-TP series are cooling only model.

The remote controller has the indication of "ECONO COOL" and a button for it, but ECONO COOL mode cannot be used since it is not available on MSY-TP series.

Operational procedure

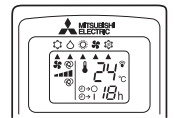
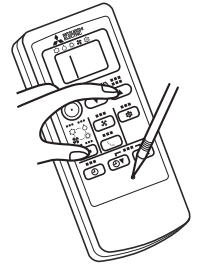
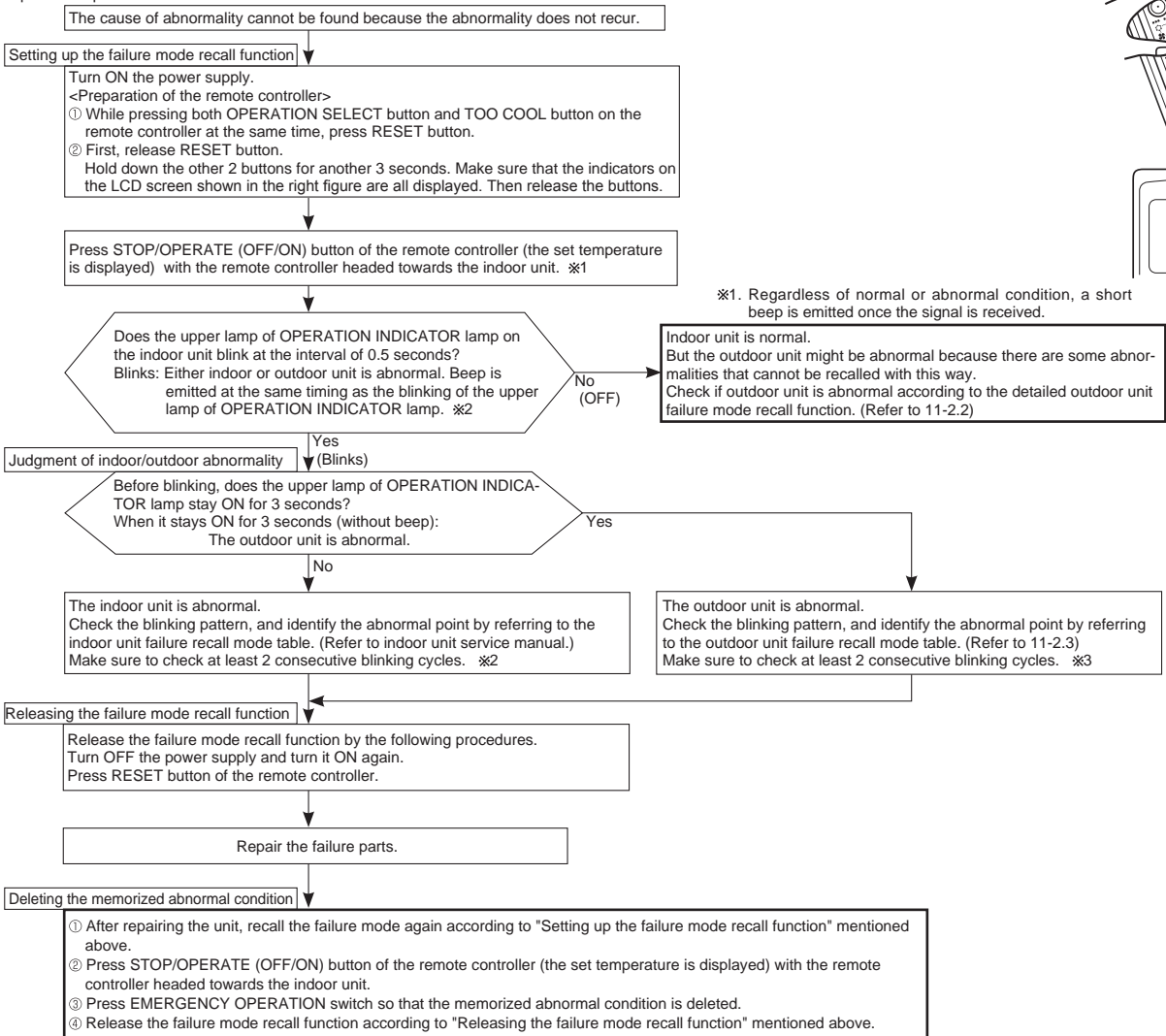

*1. Regardless of normal or abnormal condition, a short beep is emitted once the signal is received.

NOTE: 1. Make sure to release the failure mode recall function after it is set up, otherwise the unit cannot operate properly.
2. If the abnormal condition is not deleted from the memory, the last abnormal condition is kept memorized.

*2. Blinking pattern when the indoor unit is abnormal:

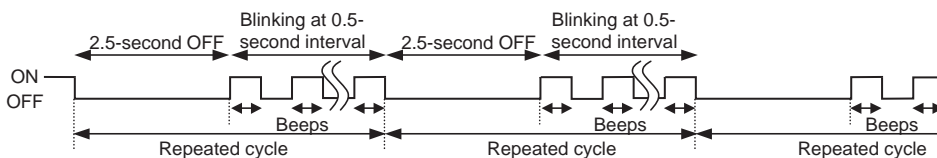

*3. Blinking pattern when the outdoor unit is abnormal:

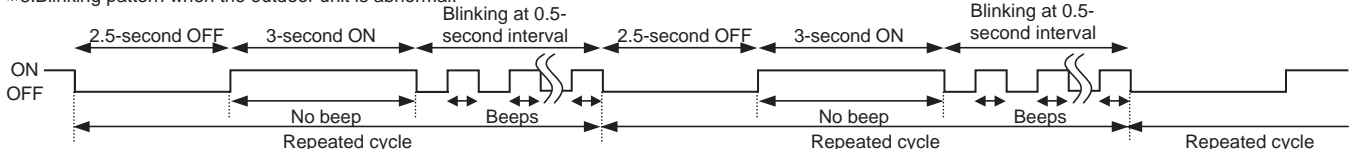

2. Flow chart of the detailed outdoor unit failure mode recall function

Operational procedure

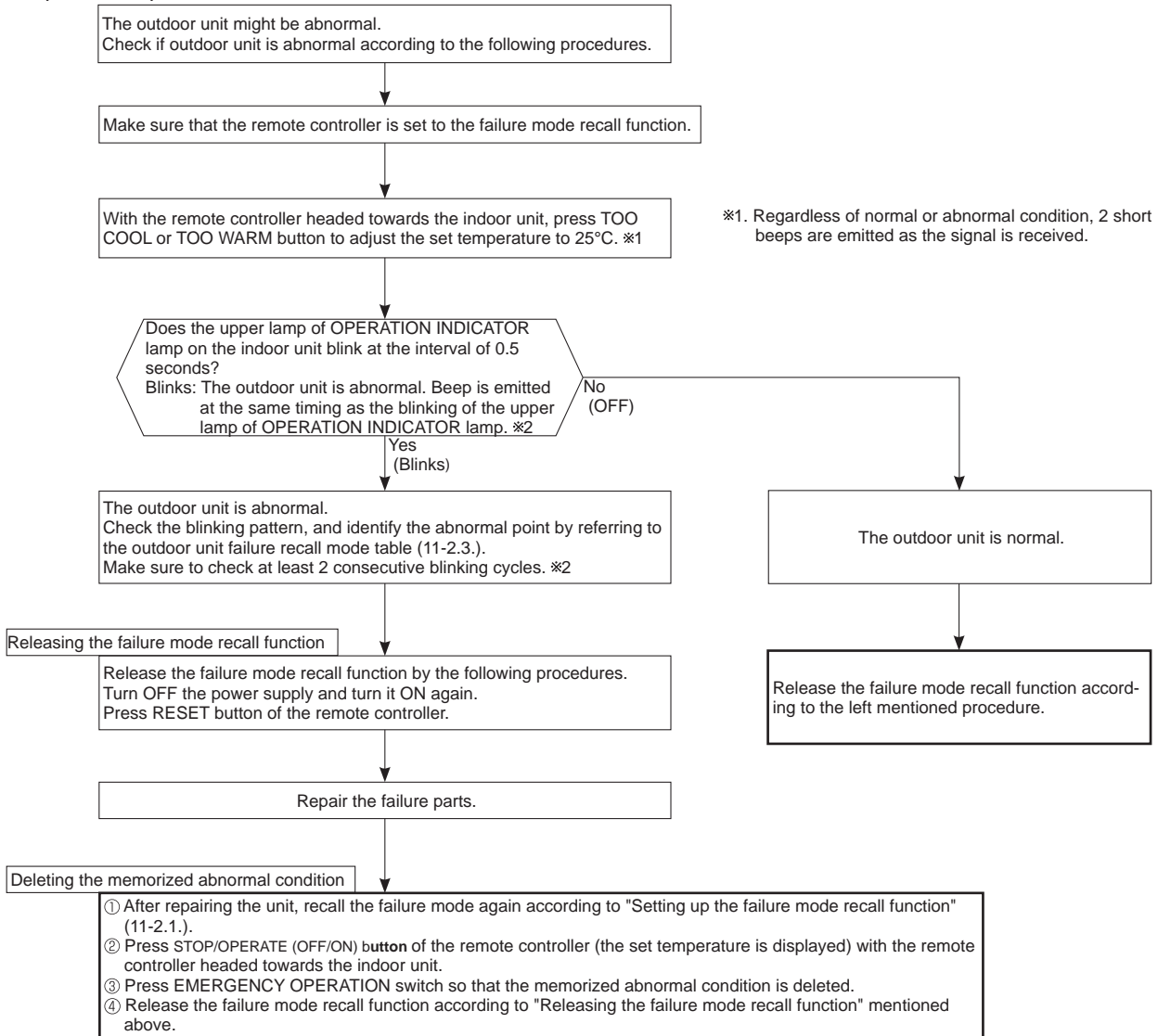

NOTE: 1. Make sure to release the failure mode recall function after it is set up, otherwise the unit cannot operate properly.
2. If the abnormal condition is not deleted from the memory, the last abnormal condition is kept memorized.

※2. Blinking pattern when outdoor unit is abnormal:

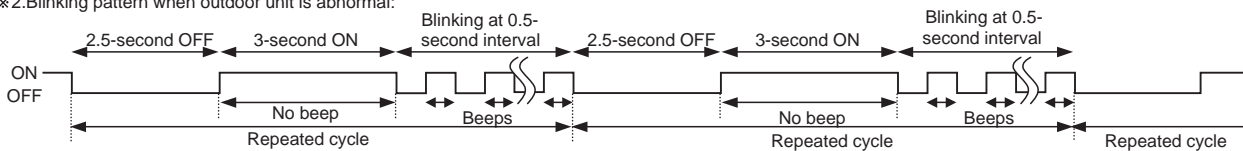

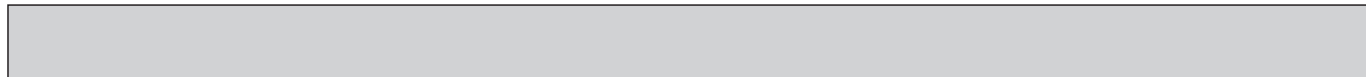

3. Outdoor unit failure recall mode table

NOTE: Blinking patterns of this mode differ from the ones of TROUBLESHOOTING CHECK TABLE (11-3.).

The upper lamp of OPERATION INDICATOR lamp (Indoor unit)	Abnormal point (Failure mode/protection)	LED indication (Outdoor P.C. board)	Condition	Remedy	Indoor/outdoor unit failure mode recall function	Outdoor unit failure mode recall function
OFF	None (Normal)	—	—	—	—	—
1-time blink 2.5 seconds OFF	Indoor/outdoor communication, receiving error	—	Any signals from the inverter P.C. board cannot be received normally for 3 minutes.	•Refer to 11-5. ㉟ How to check miswiring and serial signal error.	○	○
	Indoor/outdoor communication, receiving error	—	Although the inverter P.C. board sends signal "0", signal "1" has been received 30 consecutive times.	•Refer to 11-5. ㉟ How to check miswiring and serial signal error.		
2-time blink 2.5 seconds OFF	Outdoor power system	—	Overcurrent protection cut-out operates 3 consecutive times within 1 minute after the compressor gets started.	•Reconnect connectors. •Refer to 11-5. ㉞ "How to check inverter/compressor". •Check stop valve.	○	○
3-time blink 2.5 seconds OFF	Discharge temperature thermistor	1-time blink every 2.5 seconds	Thermistor shorts or opens during compressor running.	•Refer to 11-5. ㉟ "Check of outdoor thermistors". Defective outdoor thermistors can be identified by checking the blinking pattern of LED.	○	○
	Fin temperature thermistor	3-time blink 2.5 seconds OFF				
	P.C. board temperature thermistor	4-time blink 2.5 seconds OFF				
	Outdoor heat exchanger temperature thermistor	—				
4-time blink 2.5 seconds OFF	Overcurrent	11-time blink 2.5 seconds OFF	Large current flows into power module.	•Reconnect compressor connector. •Refer to 11-5. ㉞ "How to check inverter/compressor". •Check stop valve.	—	○
	Compressor synchronous abnormality (Compressor start-up failure protection)	12-time blink 2.5 seconds OFF	Waveform of compressor current is distorted.	•Reconnect compressor connector. •Refer to 11-5. ㉞ "How to check inverter/compressor".	—	○
5-time blink 2.5 seconds OFF	Discharge temperature	—	Temperature of discharge temperature thermistor exceeds 116°C, compressor stops. Compressor can restart if discharge temperature thermistor reads 100°C or less 3 minutes later.	•Check refrigerant circuit and refrigerant amount. •Refer to 11-5. ㉟ "Check of LEV".	—	○
6-time blink 2.5 seconds OFF	High pressure	—	Temperature of outdoor heat exchanger temperature thermistor exceeds 70°C in COOL mode.	•Check refrigerant circuit and refrigerant amount. •Check stop valve.	—	○
7-time blink 2.5 seconds OFF	Fin temperature/ P.C. board temperature	7-time blink 2.5 seconds OFF	Temperature of fin temperature thermistor on the inverter P.C. board exceeds 71-82 °C, or temperature of P.C. board temperature thermistor on the inverter P.C. board exceeds 72-78 °C.	•Check around outdoor unit. •Check outdoor unit air passage. •Refer to 11-5. ㉞ "Check of outdoor fan motor".	—	○
8-time blink 2.5 seconds OFF	Outdoor fan motor	—	Outdoor fan has stopped 3 times in a row within 30 seconds after outdoor fan start-up.	•Refer to 11-5. ㉞ "Check of outdoor fan motor". Refer to 11-5. ㉟ "Check of inverter P.C. board".	—	○
9-time blink 2.5 seconds OFF	Nonvolatile memory data	5-time blink 2.5 seconds OFF	Nonvolatile memory data cannot be read properly.	•Replace the inverter P.C. board.	○	○
	Power module	6-time blink 2.5 seconds OFF	The interface short circuit occurs in the output of the power module (IC700). The compressor winding shorts circuit.	•Refer to 11-5. ㉞ "How to check inverter/compressor".		
10-time blink 2.5 seconds OFF	Discharge temperature	—	Temperature of discharge temperature thermistor has been 50°C or less for 20 minutes.	•Refer to 11-5. ㉟ "Check of LEV". •Check refrigerant circuit and refrigerant amount.	—	○

NOTE: Blinking patterns of this mode differ from the ones of TROUBLESHOOTING CHECK TABLE (11-3.).

The upper lamp of OPERATION INDICATOR lamp (Indoor unit)	Abnormal point (Failure mode/protection)	LED indication (Outdoor P.C. board)	Condition	Remedy	Indoor/outdoor unit failure mode recall function	Outdoor unit failure mode recall function
11-time blink 2.5 seconds OFF	Bus-bar voltage (DC)	8-time blink 2.5 seconds OFF	Bus-bar voltage of inverter cannot be detected normally.	•Refer to 11-5.④"How to check inverter/compressor".	—	○
	Each phase current of compressor	9-time blink 2.5 seconds OFF	Each phase current of compressor cannot be detected normally.			
14-time blink or more 2.5 seconds OFF	Stop valve (Closed valve)	14-time blink 2.5 seconds OFF	Closed valve is detected by compressor current.	•Check stop valve.	○	○
	Pipe temperature	16-time blink 2.5 seconds OFF	The indoor coil thermistor detects an abnormal temperature.	•Replace inverter P.C. board.		
	Outdoor refrigerant system abnormality	1-time blink 2.5 seconds OFF	A closed valve and air trapped in the refrigerant circuit are detected based on the temperature sensed by the indoor and outdoor thermistors and the current of the compressor.	•Check for a gas leak in a connecting piping etc. •Check the stop valve. •Refer to 11-5. ④ "Check of outdoor refrigerant circuit".	○	○

11-3. TROUBLESHOOTING CHECK TABLE

No.	Symptom	LED indication	Abnormal point/ Condition	Condition	Remedy
1	Outdoor unit does not operate.	1-time blink every 2.5 seconds	Outdoor power system	Overcurrent protection cut-out operates 3 consecutive times within 1 minute after the compressor gets started.	<ul style="list-style-type: none"> •Reconnect connector of compressor. •Refer to 11-5.Ⓐ "How to check inverter/compressor". •Check stop valve.
2			Outdoor thermistors	Discharge temperature thermistor, fin temperature thermistor, P.C. board temperature thermistor, outdoor heat exchanger temperature thermistor or ambient temperature thermistor shorts or opens during compressor running.	•Refer to 11-5.Ⓒ "Check of outdoor thermistors".
3			Outdoor control system	Nonvolatile memory data cannot be read properly. (Upper lamp of OPERATION INDICATOR lamp on the indoor unit lights up or blinks 7-time.)	•Replace inverter P.C. board.
4		6-time blink 2.5 seconds OFF	Serial signal	The communication fails between the indoor and outdoor unit for 3 minutes.	•Refer to 11-5.Ⓓ "How to check miswiring and serial signal error.
5		11-time blink 2.5 seconds OFF	Stop valve/ Closed valve	Closed valve is detected by compressor current.	•Check stop valve.
6		14-time blink 2.5 seconds OFF	Outdoor unit (Other abnormality)	Outdoor unit is defective.	•Refer to 11-2.2. "Flow chart of the detailed outdoor unit failure mode recall function".
7		16-time blink 2.5 seconds OFF	Pipe temperature	The indoor coil thermistor detects an abnormal temperature.	•Replace the inverter P.C. board.
8		17-time blink 2.5 seconds OFF	Outdoor refrigerant system abnormality	A closed valve and air trapped in the refrigerant circuit are detected based on the temperature sensed by the indoor and outdoor thermistors and the current of the compressor.	<ul style="list-style-type: none"> •Check for a gas leak in a connecting piping etc. •Check the stop valve. •Refer to 11-5.Ⓜ "Check of outdoor refrigerant circuit".
9	'Outdoor unit stops and restarts 3 minutes later' is repeated.	2-time blink 2.5 seconds OFF	Overcurrent protection	Large current flows into power module (IC700).	<ul style="list-style-type: none"> •Reconnect connector of compressor. •Refer to 11-5.Ⓐ "How to check inverter/compressor". •Check stop valve.
10		3-time blink 2.5 seconds OFF	Discharge temperature overheat protection	Temperature of discharge temperature thermistor exceeds 116°C, compressor stops. Compressor can restart if discharge temperature thermistor reads 100°C or less 3 minutes later.	<ul style="list-style-type: none"> •Check refrigerant circuit and refrigerant amount. •Refer to 11-5.Ⓣ "Check of LEV".
11		4-time blink 2.5 seconds OFF	Fin temperature / P.C. board temperature thermistor overheat protection	Temperature of fin temperature thermistor on the heat sink exceeds 75 ~ 86°C or temperature of P.C. board temperature thermistor on the inverter P.C. board exceeds 72 ~ 85°C.	<ul style="list-style-type: none"> •Check around outdoor unit. •Check outdoor unit air passage. •Refer to 11-5.Ⓢ "Check of outdoor fan motor".
12		5-time blink 2.5 seconds OFF	High pressure protection	Temperature of outdoor heat exchanger thermistor exceeds 70°C in COOL mode.	<ul style="list-style-type: none"> •Check refrigerant circuit and refrigerant amount. •Check stop valve.
13		8-time blink 2.5 seconds OFF	Compressor synchronous abnormality	The waveform of compressor current is distorted.	<ul style="list-style-type: none"> •Reconnect connector of compressor. •Refer to 11-5.Ⓐ "How to check inverter/compressor".
14		10-time blink 2.5 seconds OFF	Outdoor fan motor	Outdoor fan has stopped 3 times in a row within 30 seconds after outdoor fan start-up.	<ul style="list-style-type: none"> •Refer to 11-5.Ⓣ "Check of outdoor fan motor. •Refer to 11-5.Ⓢ "Check of inverter P.C. board.
15		12-time blink 2.5 seconds OFF	Each phase current of compressor	Each phase current of compressor cannot be detected normally.	•Refer to 11-5.Ⓐ "How to check inverter/compressor".
16		13-time blink 2.5 seconds OFF	Bus-bar voltage (DC)	Bus-bar voltage of inverter cannot be detected normally.	<ul style="list-style-type: none"> •It occurs with following case. Instantaneous power voltage drop. (Short time power failure) •Refer to 11-5. Ⓣ "Check of power supply". •Refer to 11-5.Ⓐ "How to check inverter/compressor".
17		Outdoor unit operates.	1-time blink 2.5 seconds OFF	Frequency drop by current protection	When the input current exceeds approximately 10A, compressor frequency lowers.
18	3-time blink 2.5 seconds OFF		Frequency drop by defrosting in COOL mode	Indoor coil thermistor reads 8°C or less in COOL mode, compressor frequency lowers.	
19	4-time blink 2.5 seconds OFF		Frequency drop by discharge temperature protection	Temperature of discharge temperature thermistor exceeds 111°C, compressor frequency lowers.	<ul style="list-style-type: none"> •Check refrigerant circuit and refrigerant amount. •Refer to 11-5.Ⓣ "Check of LEV". •Refer to 11-5.Ⓒ "Check of outdoor thermistors".
20	5-time blink 2.5 seconds OFF		Outside temperature thermistor protection	When the outside temperature thermistor shorts or opens, protective operation without that thermistor is performed.	•Refer to 11-5. Ⓢ Check of outdoor thermistors.



No.	Symptom	LED indication	Abnormal point/ Condition	Condition	Remedy
21	Outdoor unit operates.	7-time blink 2.5 seconds OFF	Low discharge temperature protection	Temperature of discharge temperature thermistor has been 50°C or less for 20 minutes.	<ul style="list-style-type: none"> Refer to 11-5.④ "Check of LEV". Check refrigerant circuit and refrigerant amount.
22		8-time blink 2.5 seconds OFF	PAM protection PAM: Pulse Amplitude Modulation	The overcurrent flows into PFC (Power factor correction: IC820) or the bus-bar voltage reaches 394 V or more, PAM stops and restarts.	<p>This is not malfunction. PAM protection will be activated in the following cases:</p> <ol style="list-style-type: none"> 1 Instantaneous power voltage drop. (Short time power failure) 2 When the power supply voltage is high.
23		9-time blink 2.5 seconds OFF	Inverter check mode	The connector of compressor is disconnected, inverter check mode starts.	<ul style="list-style-type: none"> Check if the connector of the compressor is correctly connected. Refer to 11-5.④ "How to check inverter/compressor".

NOTE: 1. The location of LED is illustrated at the right figure. Refer to 11-6.1.
 2. LED is lighted during normal operation.

The blinking frequency shows the number of times the LED blinks after every 2.5-second OFF.
 (Example) When the blinking frequency is "2".

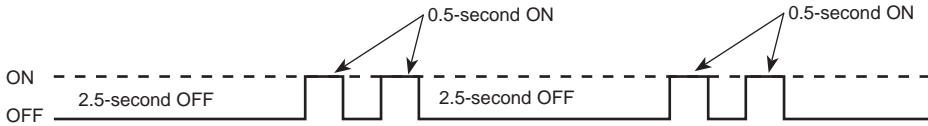

Inverter P.C. board

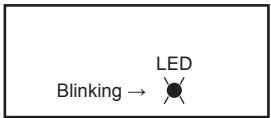

11-4. TROUBLE CRITERION OF MAIN PARTS

Part name	Check method and criterion	Figure							
Fin temperature thermistor (RT64) Ambient temperature thermistor (RT65) Outdoor heat exchanger temperature thermistor (RT68)	Measure the resistance with a tester. Refer to 11-6. "Test point diagram and voltage", 1. "Inverter P.C. board", for the chart of thermistor.								
Discharge temperature thermistor (RT62)	Measure the resistance with a tester. Before measurement, hold the thermistor with your hands to warm it up. Refer to 11-6. "Test point diagram and voltage", 1. "Inverter P.C. board", for the chart of thermistor.								
Compressor	Measure the resistance between terminals using a tester. (Temperature: -10 ~ 40°C) <table border="1"> <thead> <tr> <th></th> <th>Normal (Ω)</th> </tr> </thead> <tbody> <tr> <td>U-V</td> <td rowspan="3">0.82 ~ 1.11</td> </tr> <tr> <td>U-W</td> </tr> <tr> <td>V-W</td> </tr> </tbody> </table>		Normal (Ω)	U-V	0.82 ~ 1.11	U-W	V-W		
	Normal (Ω)								
U-V	0.82 ~ 1.11								
U-W									
V-W									
Outdoor fan motor	Measure the resistance between lead wires using a tester. (Temperature: -10 ~ 40°C) <table border="1"> <thead> <tr> <th>Color of lead wire</th> <th>Normal (Ω)</th> </tr> </thead> <tbody> <tr> <td>RED - BLK</td> <td rowspan="3">32 ~ 43</td> </tr> <tr> <td>BLK - WHT</td> </tr> <tr> <td>WHT - RED</td> </tr> </tbody> </table>	Color of lead wire	Normal (Ω)	RED - BLK	32 ~ 43	BLK - WHT	WHT - RED		
Color of lead wire	Normal (Ω)								
RED - BLK	32 ~ 43								
BLK - WHT									
WHT - RED									
Expansion valve coil (LEV)	Measure the resistance using a tester. (Temperature: -10 ~ 40°C) <table border="1"> <thead> <tr> <th>Color of lead wire</th> <th>Normal (Ω)</th> </tr> </thead> <tbody> <tr> <td>RED - ORN</td> <td rowspan="4">37 ~ 54</td> </tr> <tr> <td>RED - WHT</td> </tr> <tr> <td>RED - BLU</td> </tr> <tr> <td>RED - YLW</td> </tr> </tbody> </table>	Color of lead wire	Normal (Ω)	RED - ORN	37 ~ 54	RED - WHT	RED - BLU	RED - YLW	
Color of lead wire	Normal (Ω)								
RED - ORN	37 ~ 54								
RED - WHT									
RED - BLU									
RED - YLW									

11-5. TROUBLESHOOTING FLOW

A How to check inverter/compressor

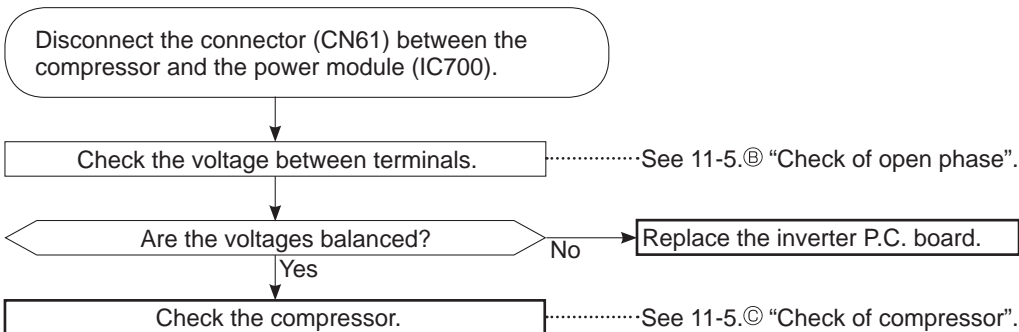

B Check of open phase

- With the connector between the compressor and the power module (IC700) disconnected, activate the inverter and check if the inverter is normal by measuring **the voltage balance** between the terminals.

Output voltage is 50 - 130 V. (The voltage may differ according to the tester.)

<< Operation method >>

Start cooling operation by pressing EMERGENCY OPERATION switch on the indoor unit. (TEST RUN OPERATION: Refer to 9-3.)

<< Measurement point >>

At 3 points

BLK (U)-WHT (V) ※ Measure AC voltage between the lead wires at 3 points.

BLK (U)-RED (W)

WHT(V)-RED (W)

- NOTE:** 1. Output voltage varies according to power supply voltage.
 2. Measure the voltage by analog type tester.
 3. During this check, LED of the inverter P.C. board blinks 9 times. (Refer to 11-6.1.)

C Check of compressor

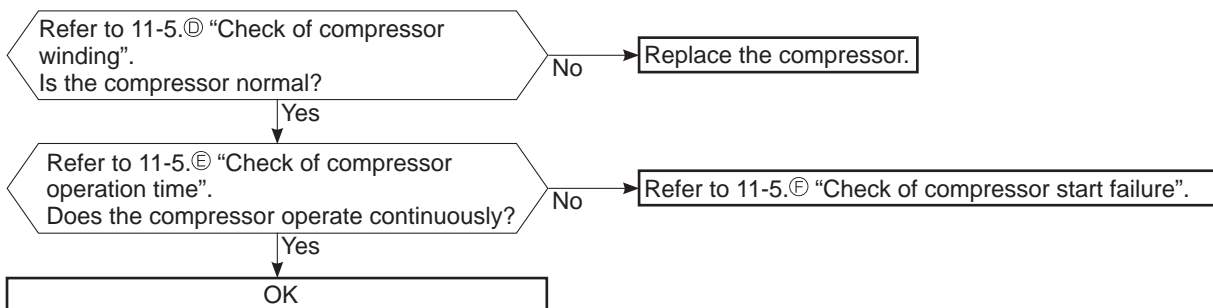

D Check of compressor winding

- Disconnect the connector (CN61) between the compressor and the power module (IC700), and measure the resistance between the compressor terminals.

<<Measurement point>>

At 3 points

BLK-WHT

BLK-RED

WHT-RED

※ Measure the resistance between the lead wires at 3 points.

<<Judgement>>

Refer to 11-4.

0 [Ω]Abnormal [short]

Infinite [Ω]Abnormal [open]

NOTE: Be sure to zero the ohmmeter before measurement.

E Check of compressor operation time

- Connect the compressor and activate the inverter. Then measure the time until the inverter stops due to overcurrent.

<<Operation method>>

Start cooling operation by pressing EMERGENCY OPERATION switch on the indoor unit. (TEST RUN OPERATION: Refer to 9-3.)

<<Measurement>>

Measure the time from the start of compressor to the stop of compressor due to overcurrent.

<<Judgement>>

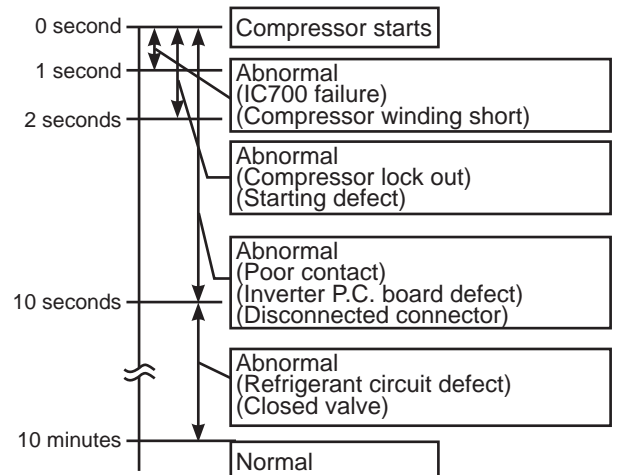

F Check of compressor start failure

Confirm that ①~④ is normal.

- Electrical circuit check

- ①. Contact of the compressor connector (Including CN61)
- ②. Output voltage of inverter P.C. board and balance of them (See 11-5.⑥)
- ③. Direct current voltage between DB61(+) and (-) on the inverter P.C. board
- ④. Voltage between outdoor terminal block S1-S2

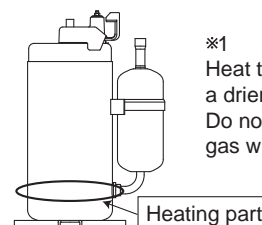
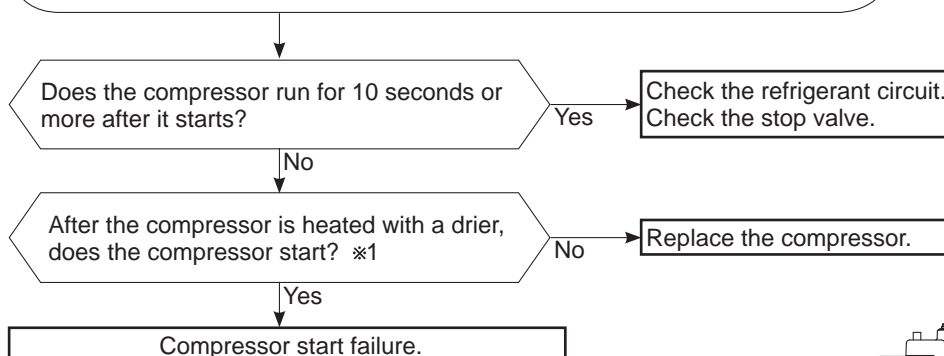

※1 Heat the compressor with a drier for about 20 minutes. Do not recover refrigerant gas while heating.

Ⓒ Check of outdoor thermistors

Disconnect the connector of thermistor in the inverter P.C. board (see below table), and measure the resistance of thermistor.

Is the resistance of thermistor normal?
(Refer to 11-6.1.)

No

Replace the thermistor except RT64.
When RT64 is abnormal, replace the inverter P.C. board.

Yes

Reconnect the connector of thermistor.
Turn ON the power supply and press EMERGENCY OPERATION switch.

Does the unit operate for 10 minutes or more
without showing thermistor abnormality?

No

Replace the inverter P.C. board.

Yes

OK (Cause is poor contact.)

Thermistor	Symbol	Connector, Pin No.	Board
Discharge temperature	RT62	Between CN641 pin3 and pin4	Inverter P.C. board
Fin temperature	RT64	Between CN642 pin1 and pin2	
Ambient temperature	RT65	Between CN643 pin1 and pin2	
Outdoor heat exchanger temperature	RT68	Between CN644 pin1 and pin3	



H Check of outdoor fan motor

Disconnect the connectors CN931 and CN932 from the inverter P.C. board.
Check the connection between the connector CN931 and CN932.

Is the resistance between each terminal of outdoor fan motor normal?
(Refer to 11-4.)

Yes

Disconnect CN932 from the inverter P.C. board, and turn on the power supply.

Rotate the outdoor fan motor manually and measure the voltage of CN931.
Between 1(+) and 5(-)
Between 2(+) and 5(-)
Between 3(+) and 5(-)

No

(Fixed to either 5 or 0 V DC)

No

Does the voltage between each terminal become 5 and 0 V DC repeatedly?

Yes

No

Does the outdoor fan motor rotate smoothly?

Yes

Replace the outdoor fan motor.

Replace the inverter P.C. board.

① Check of power supply

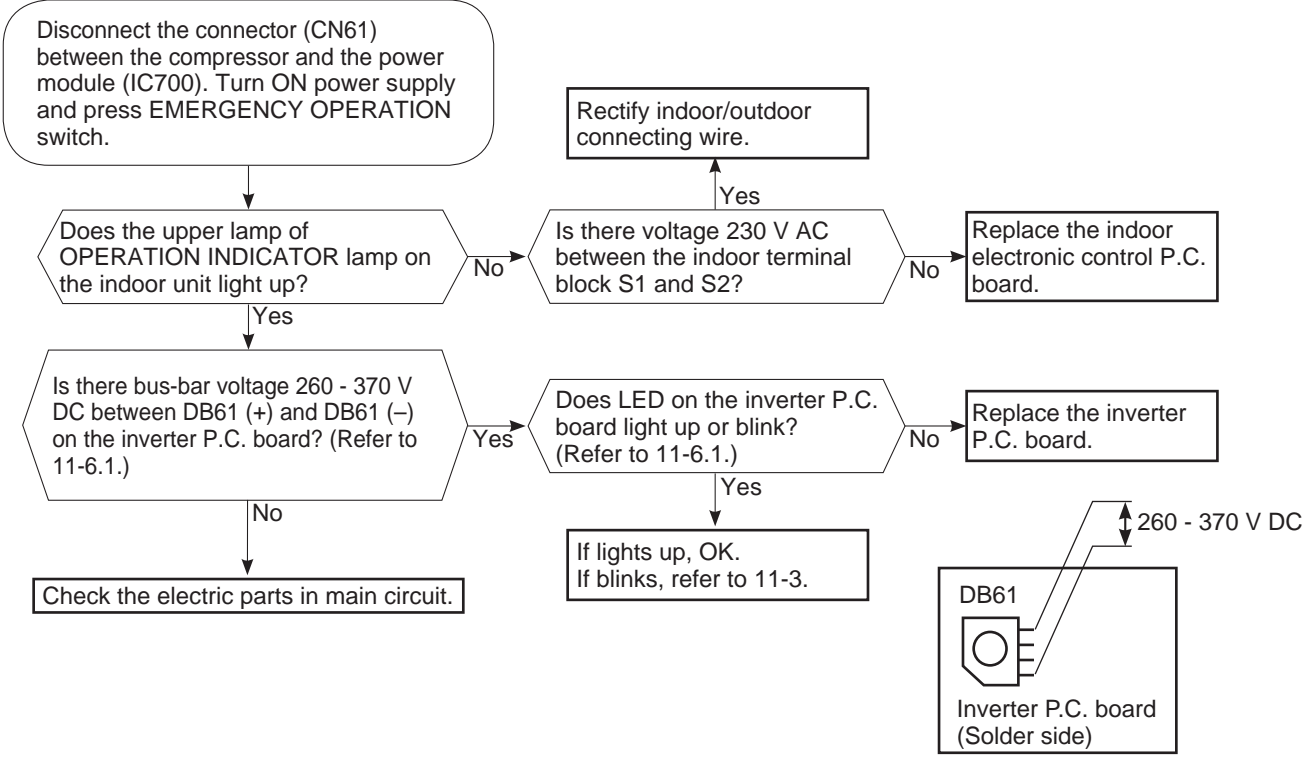



Ⓚ Check of inverter P.C. board

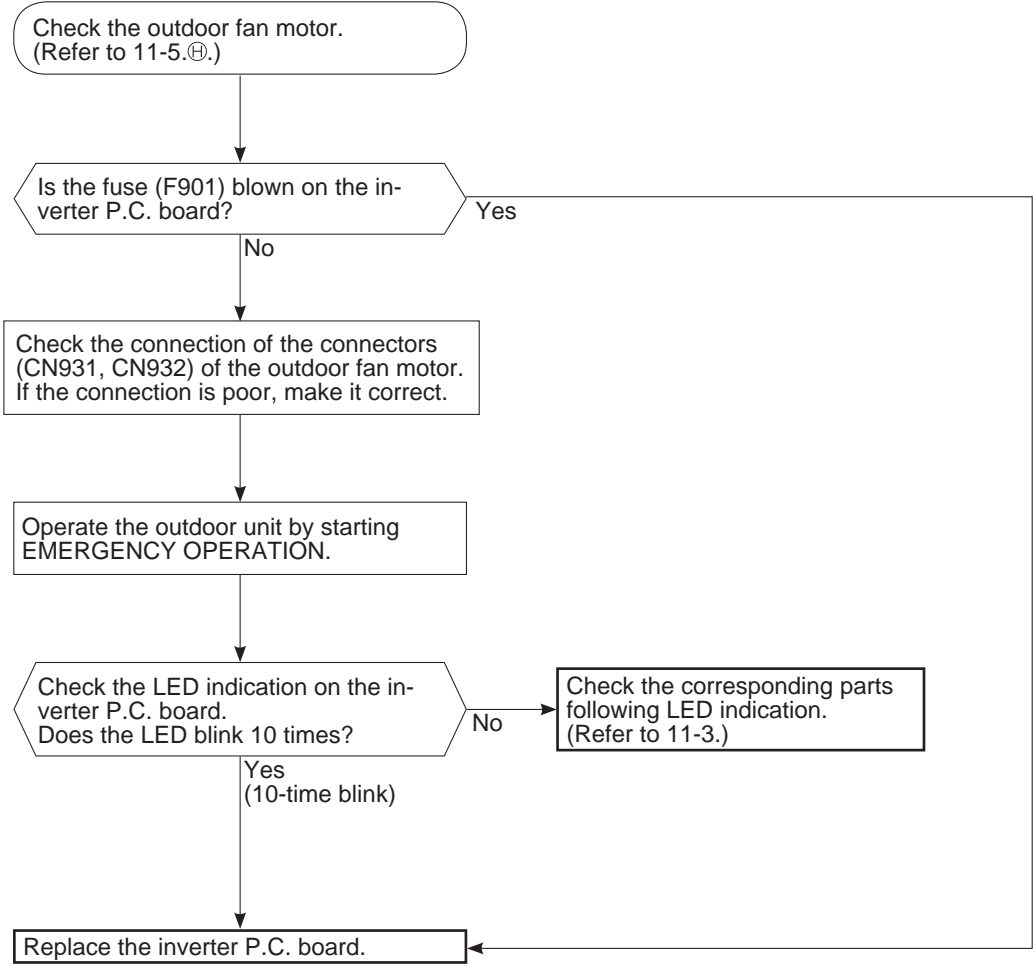

L How to check miswiring and serial signal error

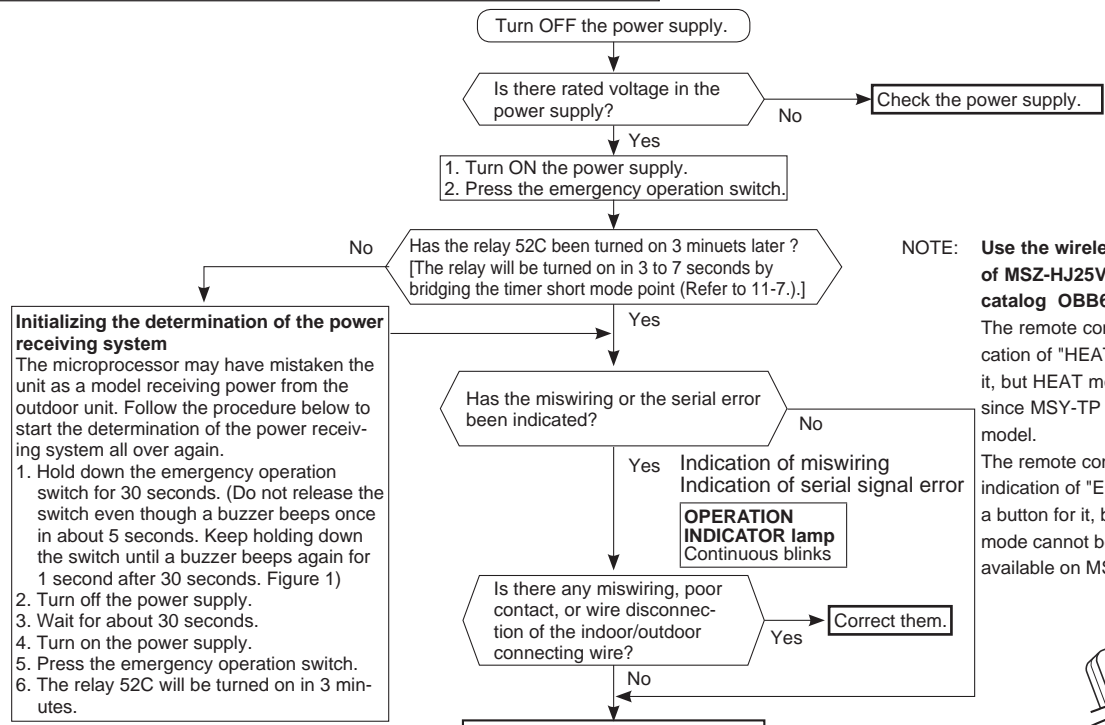

NOTE: Use the wireless remote controller of MSZ-HJ25VA-E2 (Refer to parts catalog OBB647.). The remote controller has the indication of "HEAT" and a button for it, but HEAT mode cannot be used since MSY-TP series are cooling only model. The remote controller has the indication of "ECONO COOL" and a button for it, but ECONO COOL mode cannot be used since it is not available on MSY-TP series.

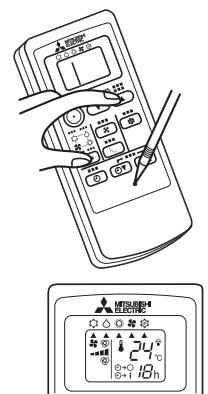
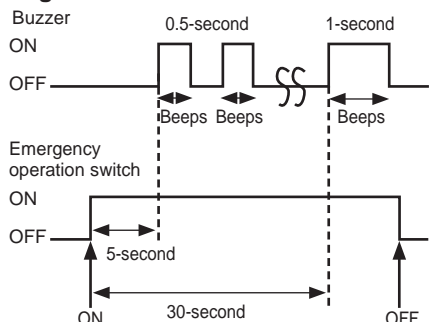

Figure 1



Turn OFF the power supply. Make sure again that the indoor/outdoor connecting wire is correctly connected. With the indoor/outdoor connecting wire connected, bridge between S2 and S3 on the outdoor terminal block. *1 <Preparation of the remote controller>
 ① While pressing both OPERATION SELECT button and TOO COOL button on the remote controller at the same time, press RESET button.
 ② First, release RESET button. Hold down the other two buttons for another 3 seconds. Make sure that the indicators on the LCD screen shown in the right figure are all displayed. Then release the buttons. (Setting up the failure mode recall function)

Aim the remote controller at the indoor unit, and press OPERATE (OFF/ON) button. The relay 52C will be turned on, and the outdoor unit will be energized.

*1 Make sure that the wiring is correct. If the procedure is performed without correcting miswiring, it may lead to damage to the P.C. board.

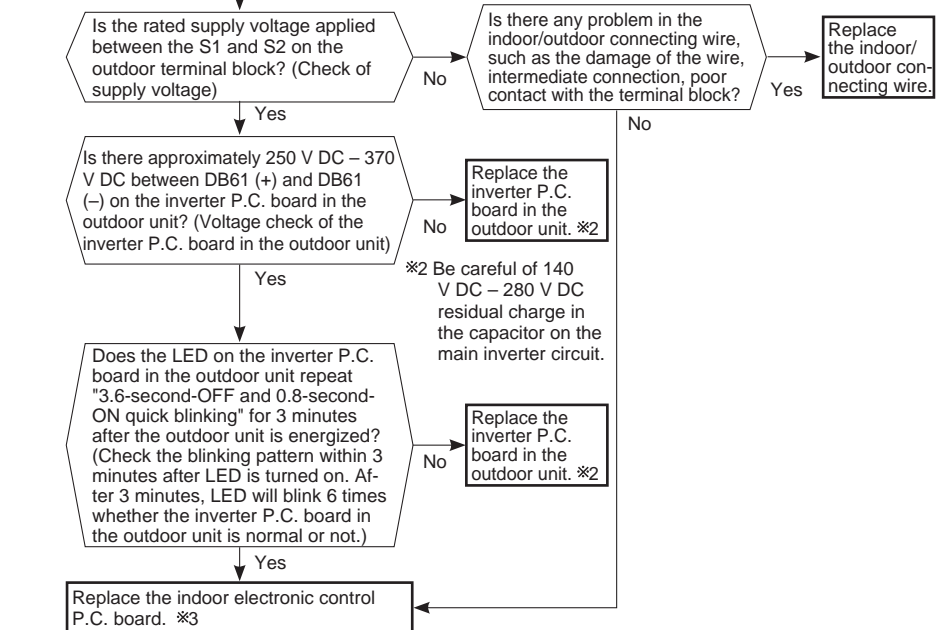
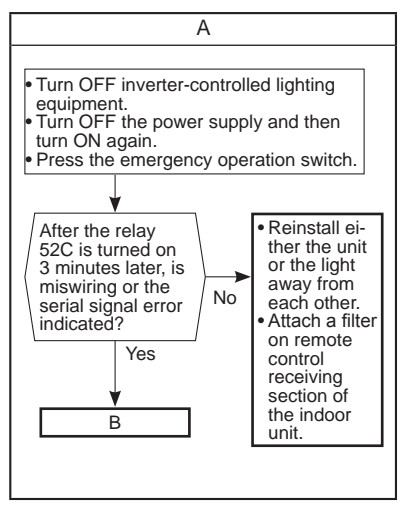

*3 Be sure to release the failure-mode recall function after checking.



M Check of the outdoor refrigerant circuit

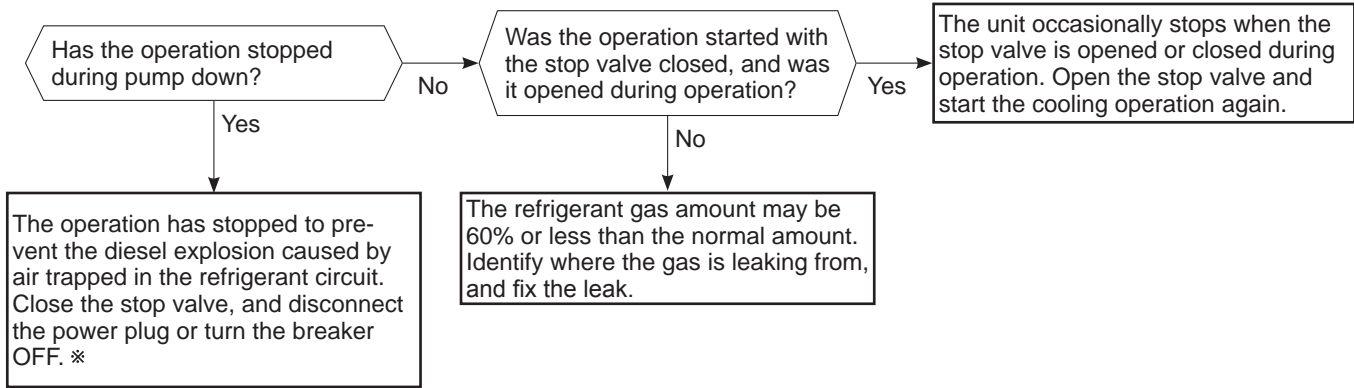

*** CAUTION : Do not start the operation again to prevent hazards.**

N Electromagnetic noise enters into TV sets or radios

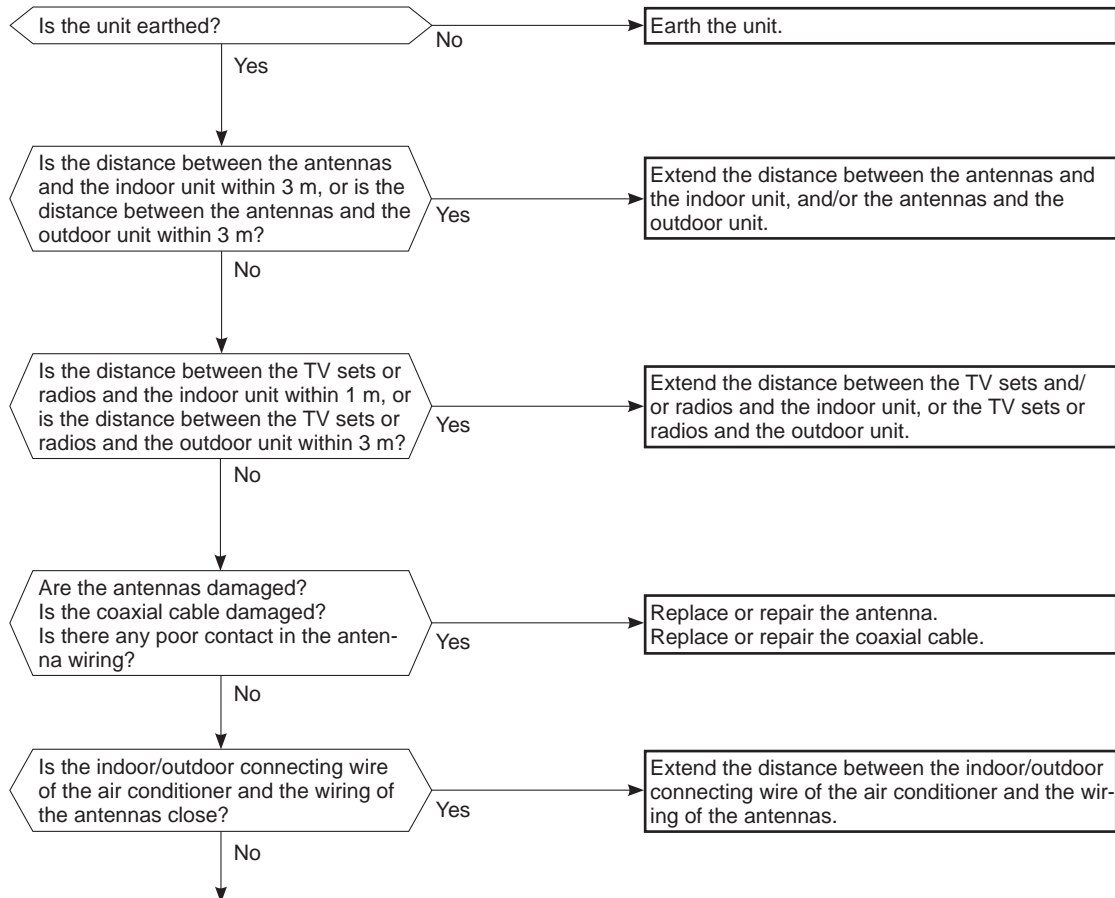

Even if all of the above conditions are fulfilled, the electromagnetic noise may enter, depending on the electric field strength or the installation condition (combination of specific conditions such as antennas or wiring).
Check the following before asking for service.

1. Devices affected by the electromagnetic noise
TV sets, radios (FM/AM broadcast, shortwave)
2. Channel, frequency, broadcast station affected by the electromagnetic noise
3. Channel, frequency, broadcast station unaffected by the electromagnetic noise
4. Layout of:
indoor/outdoor unit of the air conditioner, indoor/outdoor wiring, earth wire, antennas, wiring from antennas, receiver
5. Electric field intensity of the broadcast station affected by the electromagnetic noise
6. Presence or absence of amplifier such as booster
7. Operation condition of air conditioner when the electromagnetic noise enters in
 - 1) Turn OFF the power supply once, and then turn ON the power supply. In this situation, check for the electromagnetic noise.
 - 2) Within 3 minutes after turning ON the power supply, press [OFF/ON] button on the remote controller for power ON, and check for the electromagnetic noise.
 - 3) After a short time (3 minutes later after turning ON), the outdoor unit starts running. During operation, check for the electromagnetic noise.
 - 4) Press [OFF/ON] button on the remote controller for power OFF, when the outdoor unit stops but the indoor/outdoor communication still runs on. In this situation, check for the electromagnetic noise.

11-6. TEST POINT DIAGRAM AND VOLTAGE

1. Inverter P.C. board

MUY-TP35VF MUY-TP50VF

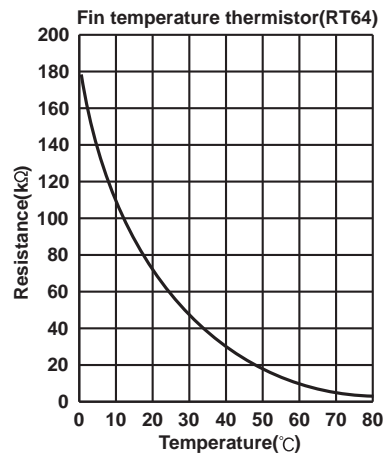
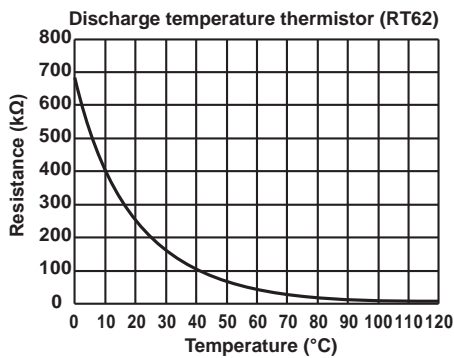
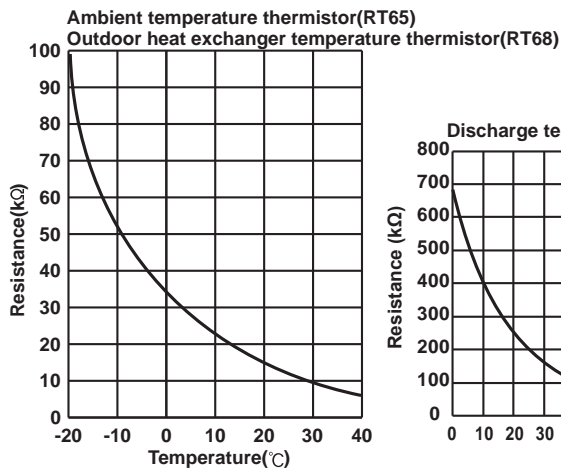
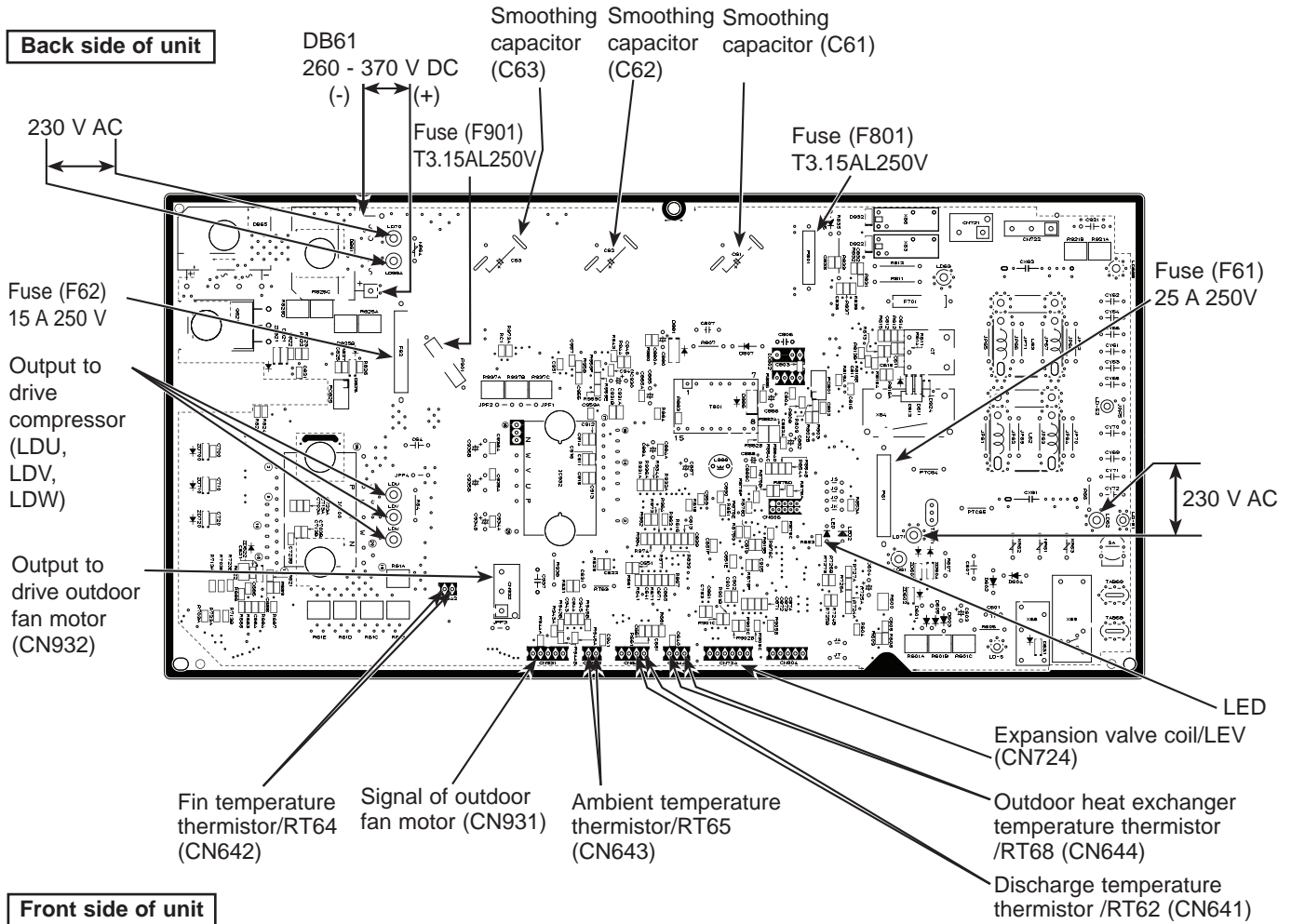

<Detaching method of the terminal with locking mechanism >

The terminal which has the locking mechanism can be detached as shown below.

There are following 2 types of the terminal with locking mechanism.

The terminal without locking mechanism can be detached by pulling it out.

Check the shape of the terminal before detaching.

(1) Slide the sleeve and check if there is a locking lever or not.

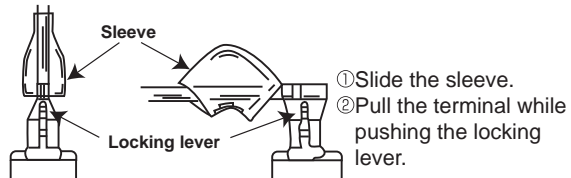

(2) The terminal with this connector shown below has the locking mechanism.

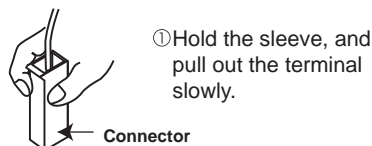

→ : Indicates the visible parts in the photos/figures.

---> : Indicates the invisible parts in the photos/figures.

12-1. MUY-TP35VF MUY-TP50VF

NOTE: Turn OFF the power supply before disassembly.

Photos: **MUY-TP35VF**

OPERATING PROCEDURE	PHOTOS/FIGURES
<p>1. Removing the cabinet</p> <ol style="list-style-type: none"> (1) Remove the screw fixing the service panel. (2) Pull down the service panel and remove it. (3) Disconnect the power supply cord and indoor/outdoor connecting wire. (4) Remove the screws fixing the top panel. (5) Remove the top panel. (6) Remove the screws fixing the cabinet. (7) Remove the cabinet. (8) Remove the screws fixing the back panel. (9) Remove the back panel. <p>Photo 3</p>	<p>Photo 1</p> <p>Photo 2</p>

OPERATING PROCEDURE

2. Removing the inverter assembly, inverter P.C. board

- (1) Remove the cabinet and panels. (Refer to section 1.)
- (2) Disconnect the lead wire to the reactor and the following connectors:
<Inverter P.C. board>
CN931, CN932 (Fan motor)
CN641 (Discharge temperature thermistor)
CN643 (Ambient temperature thermistor)
CN644 (Outdoor heat exchanger temperature thermistor)
CN724 (LEV)
- (3) Remove the compressor connector (CN61).
- (4) Remove the screws fixing the heat sink support and the separator.
- (5) Remove the fixing screws of the terminal block support and the back panel.
- (6) Remove the inverter assembly.
- (7) Remove the screw of the earth wire and screw of the terminal block support.
- (8) Remove the heat sink support from the P.C. board support.
- (9) Remove the screw of the inverter P.C. board and remove the inverter P.C. board from the P.C. board support.

3. Removing the discharge temperature thermistor, outdoor heat exchanger temperature thermistor and ambient temperature thermistor

- (1) Remove the cabinet and panels. (Refer to section 1.)
- (2) Disconnect the lead wire to the reactor and the following connectors:
<Inverter P.C. board>
CN641 (Discharge temperature thermistor)
CN643 (Ambient temperature thermistor)
CN644 (Outdoor heat exchanger temperature thermistor)
- (3) Pull out the discharge temperature thermistor from its holder.
- (4) Pull out the outdoor heat exchanger temperature thermistor from its holder.
- (5) Pull out the ambient temperature thermistor from its holder.

PHOTOS/FIGURES

Photo 4

Screws of the heat sink support and the separator Screws of the terminal block support and the back panel

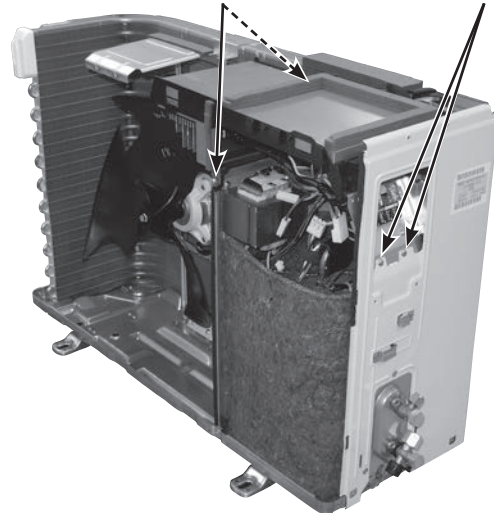

Photo 5 (Inverter assembly)

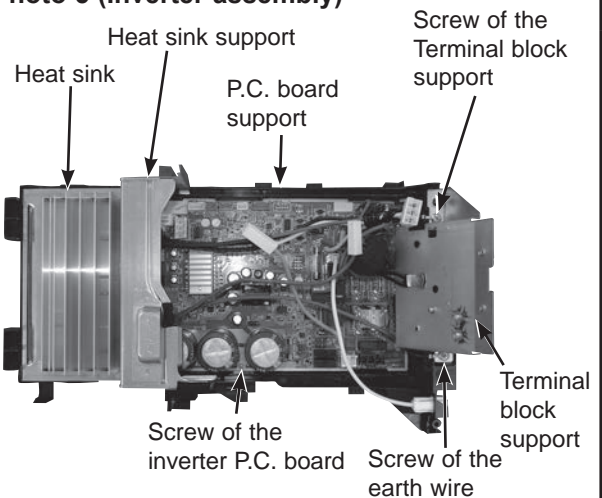
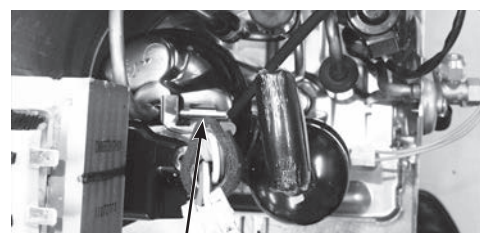

Photo 6



Discharge temperature thermistor

OPERATING PROCEDURE

4. Removing outdoor fan motor

- (1) Remove the cabinet and panels. (Refer to section 1.)
- (2) Disconnect the following connectors:
<Inverter P.C. board>
CN931, CN932 (Fan motor)
- (3) Remove the propeller fan nut.
- (4) Remove the propeller fan.
- (5) Remove the screws fixing the fan motor.
- (6) Remove the fan motor.

5. Removing the compressor

- (1) Remove the cabinet and panels. (Refer to section 1.)
- (2) Remove the inverter assembly. (Refer to section 2.)
- (3) Recover gas from the refrigerant circuit.
NOTE: Recover gas from the pipes until the pressure gauge shows 0 kg/cm² (0 MPa).
- (4) Detach the brazed part of the suction and the discharge pipe connected with compressor.
- (5) Remove the nuts of compressor legs.
- (6) Remove the compressor.

6. Removing the LEV assembly

- (1) Detaching the brazed part of pipes connected with LEV valve.

Photo 10

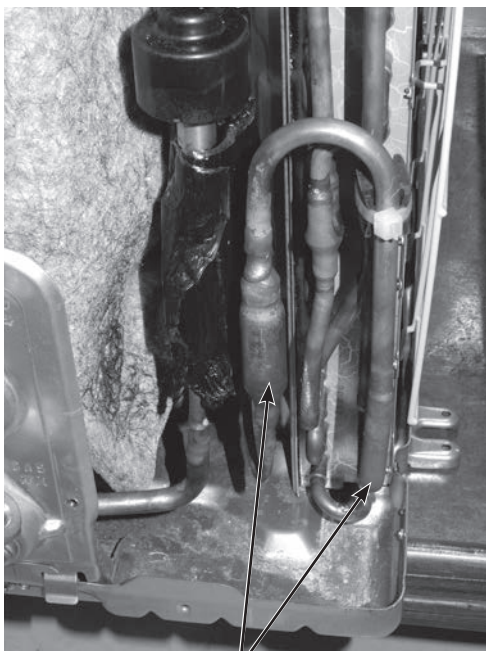

Brazed parts of LEV valve

PHOTOS/FIGURES

Photo 7

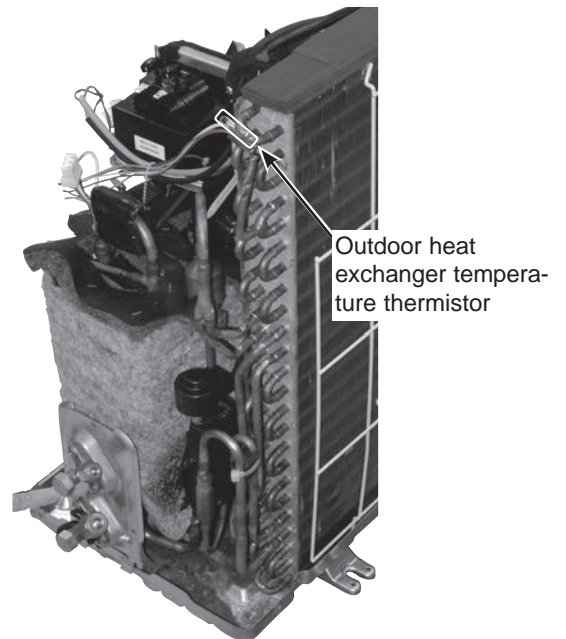

Outdoor heat exchanger temperature thermistor

Photo 8

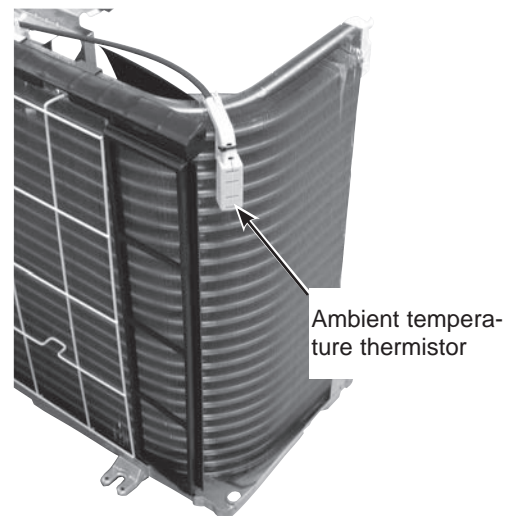

Ambient temperature thermistor

Photo 9

Screws of the outdoor fan motor



Propeller fan nut

Propeller fan

MITSUBISHI ELECTRIC CORPORATION

HEAD OFFICE: TOKYO BUILDING, 2-7-3, MARUNOUCHI, CHIYODA-KU, TOKYO 100-8310, JAPAN

© Copyright 2018 MITSUBISHI ELECTRIC CORPORATION

Issued: Jan. 2019. No. OBH817 REVISED EDITION-A

Published: Oct. 2018. No. OBH817

Made in Japan

Specifications are subject to change without notice.