

Revision A:

• MFZ-KT25/35/50/60VG-ET1 have been added.

OBH843 is void.

INDOOR UNIT

**No. OBH843
REVISED EDITION-A**

SERVICE MANUAL

Models

MFZ-KT25VG - E1, ET1

MFZ-KT35VG - E1, ET1

MFZ-KT50VG - E1, ET1

MFZ-KT60VG - E1, ET1

**Outdoor unit service manual
SUZ-M•VA Series (OCH684)
MXZ-F•VF Series (OBH790)**

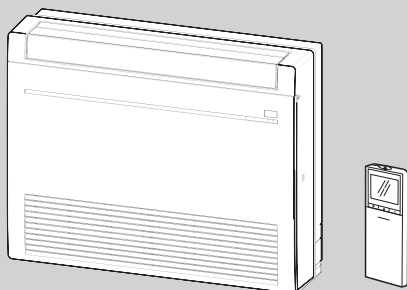

**MFZ-KT25VG
MFZ-KT35VG
MFZ-KT50VG
MFZ-KT60VG**

CONTENTS

1. TECHNICAL CHANGES	2
2. SAFETY PRECAUTION	3
3. PART NAMES AND FUNCTIONS	7
4. SPECIFICATION	8
5. NOISE CRITERIA CURVES	9
6. OUTLINES AND DIMENSIONS	11
7. WIRING DIAGRAM	12
8. REFRIGERANT SYSTEM DIAGRAM	13
9. SERVICE FUNCTIONS	15
10. MICROPROCESSOR CONTROL	17
11. TROUBLESHOOTING	25
12. DISASSEMBLY INSTRUCTIONS	37

PARTS CATALOG (OBB843)

Use the specified refrigerant only

Never use any refrigerant other than that specified.

Doing so may cause a burst, an explosion, or fire when the unit is being used, serviced, or disposed of.

Correct refrigerant is specified in the manuals and on the spec labels provided with our products.

We will not be held responsible for mechanical failure, system malfunction, unit breakdown or accidents caused by failure to follow the instructions.

<Preparation before the repair service>

- Prepare the proper tools.
- Prepare the proper protectors.
- Provide adequate ventilation.
- After stopping the operation of the air conditioner, turn off the power-supply breaker and remove the power plug.
- Discharge the capacitor before the work involving the electric parts.

<Precautions during the repair service>

- Do not perform the work involving the electric parts with wet hands.
- Do not pour water into the electric parts.
- Do not touch the refrigerant.
- Do not touch the hot or cold areas in the refrigeration cycle.
- When the repair or the inspection of the circuit needs to be done without turning off the power, exercise great caution not to touch the live parts.

1

TECHNICAL CHANGES

MFZ-KT25VG-E1, ET1

MFZ-KT35VG-E1, ET1

MFZ-KT50VG-E1, ET1

MFZ-KT60VG-E1, ET1

1. New model

2-1. CAUTIONS RELATED TO NEW REFRIGERANT

Cautions for units utilizing refrigerant R32/R410A



WARNING

1. Warning for service

- (1) In case of reconnecting the refrigerant pipes after detaching, make the flared part of pipe re-fabricated.
- (2) This unit should be installed in rooms which exceed the floor space specified in outdoor unit installation manual. Refer to outdoor unit installation manual.
- (3) Refrigerant pipes connection shall be accessible for maintenance purposes.
- (4) Do not use low temperature solder alloy in case of brazing the refrigerant pipes.
- (5) Do not use means to accelerate the defrosting process or to clean, other than those recommended by the manufacturer.
- (6) The appliance shall be stored in a room without continuously operating ignition sources (for example: open flames, an operating gas appliance or an operating electric heater).
- (7) Do not pierce or burn.
- (8) Be aware that refrigerants may not contain an odour.
- (9) Pipe-work shall be protected from physical damage.
- (10) The installation of pipe-work shall be kept to a minimum.
- (11) Compliance with national gas regulations shall be observed.
- (12) Keep any required ventilation openings clear of obstruction.
- (13) Servicing shall be performed only as recommended by the manufacturer.
- (14) The appliance shall be stored in a well-ventilated area where the room size corresponds to the room area as specified for operation.
- (15) Maintenance, service and repair operations shall be performed by authorized technician with required qualification.

2. Cautions for unit using R32 refrigerant

Basic work procedures are the same as those for conventional units using refrigerant R410A. However, pay careful attention to the following points.

- (1) Information on servicing
 - (1-1) Checks on the Area

Prior to beginning work on systems containing flammable refrigerants, safety checks are necessary to ensure that the risk of ignition is minimized.

For repair to the refrigerating systems, (1-3) to (1-7) shall be completed prior to conducting work on the systems.
 - (1-2) Work Procedure

Work shall be undertaken under a controlled procedure so as to minimize the risk of a flammable gas or vapor being present while the work is being performed.
 - (1-3) General Work Area

All maintenance staff and others working in the local area shall be instructed on the nature of work being carried out. Work in confined spaces shall be avoided. The area around the workspace shall be sectioned off. Ensure that the conditions within the area have been made safe by control of flammable material.
 - (1-4) Checking for Presence of Refrigerant

The area shall be checked with an appropriate refrigerant detector prior to and during work, to ensure the technician is aware of potentially toxic or flammable atmospheres. Ensure that the leak detection equipment being used is suitable for use with all applicable refrigerants, i.e. non-sparking, adequately sealed or intrinsically safe.
 - (1-5) Presence of Fire Extinguisher

If any hot work is to be conducted on the refrigeration equipment or any associated parts, appropriate fire extinguishing equipment shall be available to hand.

Have a dry powder or CO2 fire extinguisher adjacent to the charging area.
 - (1-6) No Ignition Sources

No person carrying out work in relation to a refrigeration system which involves exposing any pipe work shall use any sources of ignition in such a manner that it may lead to the risk of fire or explosion. All possible ignition sources, including cigarette smoking, should be kept sufficiently far away from the site of installation, repairing, removing and disposal, during which refrigerant can possibly be released to the surrounding space. Prior to work taking place, the area around the equipment is to be surveyed to make sure that there are no flammable hazards or ignition risks. "No Smoking" signs shall be displayed.
 - (1-7) Ventilated Area

Ensure that the area is in the open or that it is adequately ventilated before breaking into the system or conducting any hot work. A degree of ventilation shall continue during the period that the work is carried out. The ventilation should safely disperse any released refrigerant and preferably expel it externally into the atmosphere.

(1-8) Checks on the Refrigeration Equipment

Where electrical components are being changed, they shall be fit for the purpose and to the correct specification. At all times the manufacturer's maintenance and service guidelines shall be followed. If in doubt, consult the manufacturer's technical department for assistance.

The following checks shall be applied to installations using flammable refrigerants:

- The charge size is in accordance with the room size within which the refrigerant containing parts are installed.
- The ventilation machinery and outlets are operating adequately and are not obstructed.
- Marking to the equipment continues to be visible and legible. Markings and signs that are illegible shall be corrected.
- Refrigeration pipe or components are installed in a position where they are unlikely to be exposed to any substance which may corrode refrigerant containing components, unless the components are constructed of materials which are inherently resistant to being corroded or are suitably protected against being corroded.

(1-9) Checks on Electrical Devices

Repair and maintenance to electrical components shall include initial safety checks and component inspection procedures. If a fault exists that could compromise safety, then no electrical supply shall be connected to the circuit until it is satisfactorily dealt with. If the fault cannot be corrected immediately but it is necessary to continue operation, an adequate temporary solution shall be used. This shall be reported to the owner of the equipment so all parties are advised. Initial safety checks shall include that:

- capacitors are discharged: this shall be done in a safe manner to avoid possibility of sparking;
- no live electrical components and wiring are exposed while charging, recovering or purging the system;
- there is continuity of earth bonding

(2) Repairs to Sealed Components

(2-1) During repairs to sealed components, all electrical supplies shall be disconnected from the equipment being worked upon prior to any removal of sealed covers, etc. If it is absolutely necessary to have an electrical supply to equipment during servicing, then a permanently operating form of leak detection shall be located at the most critical point to warn of a potentially hazardous situation.

(2-2) Particular attention shall be paid to the following to ensure that by working on electrical components, the casing is not altered in such a way that the level of protection is affected. This shall include damage to cables, excessive number of connections, terminals not made to original specification, damage to seals, incorrect fitting of glands, etc.

Ensure that the apparatus is mounted securely.

Ensure that seals or sealing materials have not degraded to the point that they no longer serve the purpose of preventing the ingress of flammable atmospheres.

Replacement parts shall be in accordance with the manufacturer's specifications.

(3) Repair to Intrinsically Safe Components

Do not apply any permanent inductive or capacitance loads to the circuit without ensuring that this will not exceed the permissible voltage and current permitted for the equipment in use.

Intrinsically safe components are the only types that can be worked on while live in the presence of a flammable atmosphere. The test apparatus shall be at the correct rating.

Replace components only with parts specified by the manufacturer. Other parts may result in the ignition of refrigerant in the atmosphere from a leak.

(4) Cabling

Check that cabling will not be subject to wear, corrosion, excessive pressure, vibration, sharp edges or any other adverse environmental effects. The check shall also take into account the effects of aging or continual vibration from sources such as compressors or fans.

(5) Detection of Flammable Refrigerants

Under no circumstances shall potential sources of ignition be used in the searching for or detection of refrigerant leaks.

A halide torch (or any other detector using a naked flame) shall not be used.

(6) Leak Detection Methods

Electronic leak detectors may be used to detect refrigerant leaks but, in the case of flammable refrigerants, the sensitivity may not be adequate, or may need re-calibration. (Detection equipment shall be calibrated in a refrigerant-free area.)

Ensure that the detector is not a potential source of ignition and is suitable for the refrigerant used. Leak detection equipment shall be set at a percentage of the LFL of the refrigerant and shall be calibrated to the refrigerant employed, and the appropriate percentage of gas (25% maximum) is confirmed.

Leak detection fluids are suitable for use with most refrigerants but the use of detergents containing chlorine shall be avoided as the chlorine may react with the refrigerant and corrode the copper pipe-work.

If a leak is suspected, all naked flames shall be removed/extinguished.

If a leakage of refrigerant is found which requires brazing, all of the refrigerant shall be recovered from the system, or isolated (by means of shut off valves) in a part of the system remote from the leak. For appliances containing flammable refrigerants, oxygen free nitrogen (OFN) shall then be purged through the system both before and during the brazing process.

(7) Removal and Evacuation

When breaking into the refrigerant circuit to make repairs – or for any other purpose conventional procedures shall be used. However, for flammable refrigerants it is important that best practice is followed since flammability is a consideration. The following procedure shall be adhered to:

- remove refrigerant
- purge the circuit with inert gas
- evacuate
- purge again with inert gas
- open the circuit by cutting or brazing.

The refrigerant charge shall be recovered into the correct recovery cylinders. For appliances containing flammable refrigerants, the system shall be “flushed” with OFN to render the unit safe. This process may need to be repeated several times.

Compressed air or oxygen shall not be used for purging refrigerant systems.

For appliances containing flammable refrigerants, flushing shall be achieved by breaking the vacuum in the system with OFN and continuing to fill until the working pressure is achieved, then venting to atmosphere, and finally pulling down to a vacuum. This process shall be repeated until no refrigerant is within the system. When the final OFN charge is used, the system shall be vented down to atmospheric pressure to enable work to take place. This operation is absolutely vital if brazing operations on the pipe-work are to take place.

Ensure that the outlet for the vacuum pump is not close to any ignition sources and that ventilation is available.

(8) Charging Procedures

In addition to conventional charging procedures, the following requirements shall be followed:

- Ensure that contamination of different refrigerants does not occur when using charging equipment. Hoses or lines shall be as short as possible to minimize the amount of refrigerant contained in them.
- Cylinders shall be kept upright.
- Ensure that the refrigeration system is earthed prior to charging the system with refrigerant.
- Label the system when charging is complete (if not already).
- Extreme care shall be taken not to overfill the refrigeration system.

Prior to recharging the system, it shall be pressure-tested with the appropriate purging gas. The system shall be leak-tested on completion of charging but prior to commissioning. A follow up leak test shall be carried out prior to leaving the site.

(9) Decommissioning

Before carrying out this procedure, it is essential that the technician is completely familiar with the equipment and all its detail. It is recommended good practice that all refrigerants are recovered safely. Prior to the task being carried out, an oil and refrigerant sample shall be taken in case analysis is required prior to re-use of reclaimed refrigerant. It is essential that electrical power is available before the task is commenced.

- a) Become familiar with the equipment and its operation.
- b) Isolate system electrically.
- c) Before attempting the procedure, ensure that:
 - mechanical handling equipment is available, if required, for handling refrigerant cylinders;
 - all personal protective equipment is available and being used correctly;
 - the recovery process is supervised at all times by a competent person;
 - recovery equipment and cylinders conform to the appropriate standards.
- d) Pump down refrigerant system, if possible.
- e) If a vacuum is not possible, make a manifold so that refrigerant can be removed from various parts of the system.
- f) Make sure that cylinder is situated on the scales before recovery takes place.
- g) Start the recovery machine and operate in accordance with manufacturer’s instructions.
- h) Do not overfill cylinders. (No more than 80 % volume liquid charge).
- i) Do not exceed the maximum working pressure of the cylinder, even temporarily.
- j) When the cylinders have been filled correctly and the process completed, make sure that the cylinders and the equipment are removed from site promptly and all isolation valves on the equipment are closed off.
- k) Recovered refrigerant shall not be charged into another refrigeration system unless it has been cleaned and checked.

(10) Labelling

Equipment shall be labelled stating that it has been de-commissioned and emptied of refrigerant. The label shall be dated and signed. For appliances containing flammable refrigerants, ensure that there are labels on the equipment stating the equipment contains flammable refrigerant.

(11) Recovery

When removing refrigerant from a system, either for servicing or decommissioning, it is recommended good practice that all refrigerants are removed safely. When transferring refrigerant into cylinders, ensure that only appropriate refrigerant recovery cylinders are employed. Ensure that the correct number of cylinders for holding the total system charge are available. All cylinders to be used are designated for the recovered refrigerant and labelled for that refrigerant (i.e. special cylinders for the recovery of refrigerant). Cylinders shall be complete with pressure-relief valve and associated shut-off valves in good working order. Empty recovery cylinders are evacuated and, if possible, cooled before recovery occurs.

The recovery equipment shall be in good working order with a set of instructions concerning the equipment that is at hand and shall be suitable for the recovery of all appropriate refrigerants including, when applicable, flammable refrigerants. In addition, a set of calibrated weighing scales shall be available and in good working order. Hoses shall be complete with leak-free disconnect couplings and in good condition. Before using the recovery machine, check that it is in satisfactory working order, has been properly maintained and that any associated electrical components are sealed to prevent ignition in the event of a refrigerant release. Consult manufacturer if in doubt.

The recovered refrigerant shall be returned to the refrigerant supplier in the correct recovery cylinder, and the relevant waste transfer note arranged. Do not mix refrigerants in recovery units and especially not in cylinders. If compressors or compressor oils are to be removed, ensure that they have been evacuated to an acceptable level to make certain that flammable refrigerant does not remain within the lubricant. The evacuation process shall be carried out prior to returning the compressor to the suppliers. Only electric heating to the compressor body shall be employed to accelerate this process. When oil is drained from a system, it shall be carried out safely.

3

PART NAMES AND FUNCTIONS

MFZ-KT25VG MFZ-KT35VG MFZ-KT50VG MFZ-KT60VG

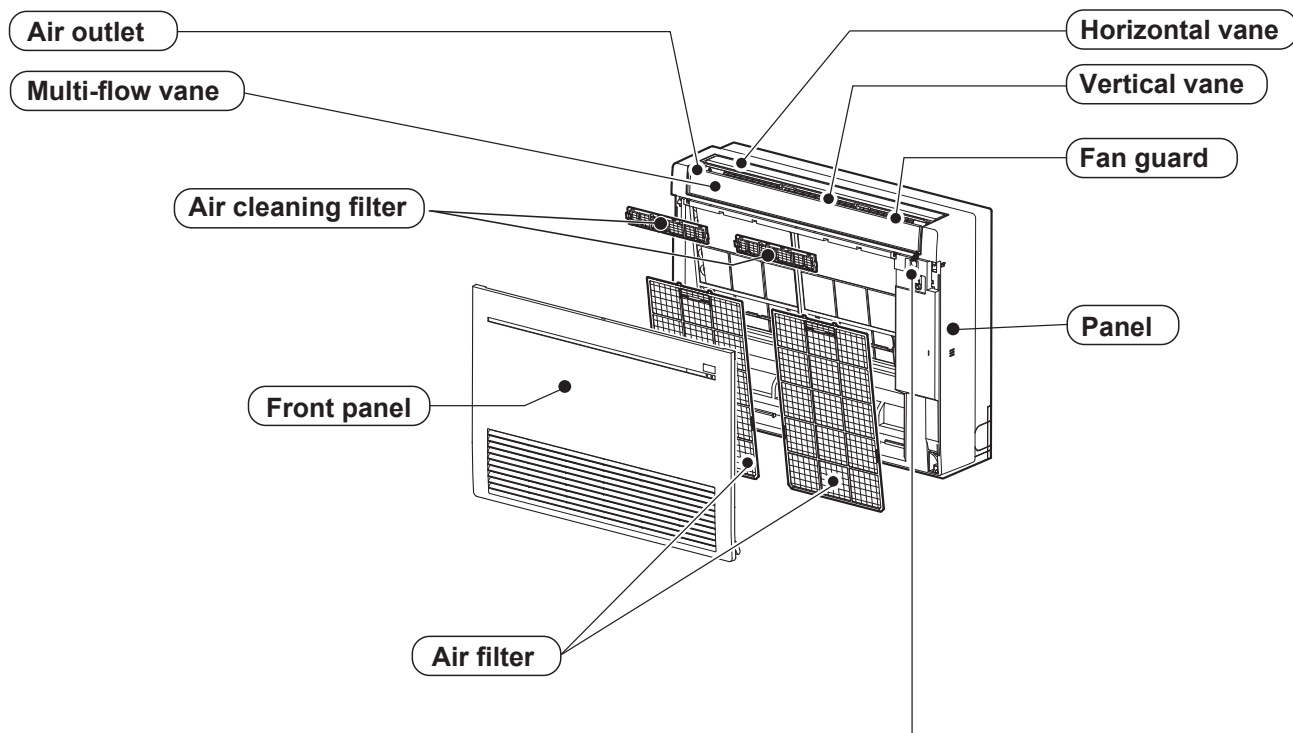

Display and operation section (When the front panel is opened)

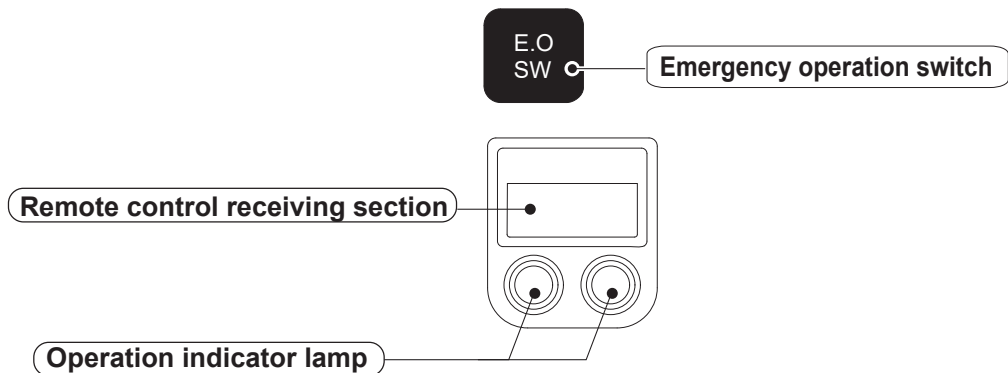

ACCESSORIES

	Model	MFZ-KT25/35/50VG	MFZ-KT60VG
①	Remote controller holder	1	1
②	Fixing screw for 1.3.5 x 16 mm (Black)	2	2
③	Pipe cover	1	1
④	Band	2	2
⑤	Battery (AAA) for remote controller	2	2
⑥	Indoor unit mounting bracket	1	1
⑦	Fixing screw for 6.4 x 25 mm	5	5
⑧	Wood screw for the indoor unit fixation	4	4
⑨	Washer of 8	4	4
⑩	Felt tape (Used for left or left-rear piping)	1	1
⑪	Wireless remote controller	1	1
⑫	Air cleaning filter	2	2
⑬	Breaker tag	1	1
⑭	Breaker notice	1	1
⑮	Joint pipe	-	1
⑯	Pipe cover for joint pipe	-	1

4

SPECIFICATION

Indoor model				MFZ-KT25VG	MFZ-KT35VG	MFZ-KT50VG	MFZ-KT60VG	
Power supply				Single phase 230 V, 50 Hz				
Electrical data	Power input *1	Cooling	W	20		37	63	
		Heating		24		52	59	
	Running current *1	Cooling	A	0.17		0.34	0.55	
		Heating		0.20		0.45	0.49	
Fan motor	Model			RC0J30-Q#		RC0J40-P#		
	Current *1	Cooling	A	0.14		0.32	0.52	
		Heating		0.17		0.43	0.46	
Dimensions W × H × D			mm	750 × 600 × 215				
Weight			kg	14.5			15	
Air direction				1 FLOW: 4, 2 FLOW: 4				
Special remarks (Single)	Airflow	Cooling	Super High	m ³ /h	534	738	900	
			High		468	624	738	
			Med.		390	516	576	
			Low		288	402	480	
			Silent		234	336	336	
		Heating	Super High	m ³ /h	582	840	876	
			High		438	696	750	
			Med.		336	564	582	
			Low		240	462	462	
			Silent		210	360	360	
		Sound level	Cooling	Super High	dB(A)	41	48	53
				High		37	42	46
	Med.			31		37	40	
	Low			24		32	36	
	Silent			19		28	28	
	Heating		Super High	dB(A)	44	49	51	
			High		37	44	47	
			Med.		30	40	41	
			Low		23	35	35	
			Silent		19	29	29	
	Fan speed	Cooling	Super High	rpm	1000	1120	1330	
			High		900	970	1120	
			Med.		770	820	900	
			Low		610	670	770	
Silent			520		580	580		
Heating		Super High	rpm	1080	1250	1300		
		High		850	1060	1130		
		Med.		690	890	910		
		Low		530	750	750		
		Silent		480	610	610		
Special remarks (Multi)	Airflow	Cooling	Super High	m ³ /h	540	738	900	
			High		468	624	738	
			Med.		390	516	576	
			Low		288	402	480	
			Silent		252	336	336	
		Heating	Super High	m ³ /h	582	840	876	
			High		468	696	750	
			Med.		378	564	582	
			Low		294	462	462	
			Silent		252	360	360	
		Sound level	Cooling	Super High	dB(A)	43	48	53
				High		38	42	46
	Med.			33		37	40	
	Low			28		32	36	
	Silent			23		28	28	
	Heating		Super High	dB(A)	44	49	51	
			High		39	44	47	
			Med.		34	40	41	
			Low		28	35	35	
			Silent		24	29	29	
	Fan speed	Cooling	Super High	rpm	1010	1120	1330	
			High		900	970	1120	
			Med.		770	820	900	
			Low		610	670	770	
Silent			550		580	580		
Heating		Super High	rpm	1080	1250	1300		
		High		900	1060	1130		
		Med.		750	890	910		
		Low		620	750	750		
		Silent		550	610	610		
Fan speed regulator				5				
Remote controller model				SG191				

NOTE: Test conditions are based on ISO 5151.

Cooling: Indoor Dry-bulb temperature 27°C Wet-bulb temperature 19°C

Outdoor Dry-bulb temperature 35°C

Heating: Indoor Dry-bulb temperature 20°C

Outdoor Dry-bulb temperature 7°C Wet-bulb temperature 6°C

*1 Measured under rated operating frequency.

Specifications and rating conditions of main electric parts

Item	Model	MFZ-KT25VG MFZ-KT35VG MFZ-KT50VG MFZ-KT60VG			
Fuse	(F11)	T3.15AL250V			
Horizontal vane motor (Front)	(MV1)	12 V DC 250 Ω			
Horizontal vane motor (Back)	(MV2)	12 V DC 250 Ω			
Multi-flow vane motor	(MV3)	12 V DC 350 Ω			
Terminal block	(TB)	3P			
Varistor	(NR11)	S10K300E2K1			

5

NOISE CRITERIA CURVES

MFZ-KT25VG

FAN SPEED	FUNCTION	SPL(dB(A))	LINE
Super High	COOLING	41	●—●
	HEATING	44	○—○

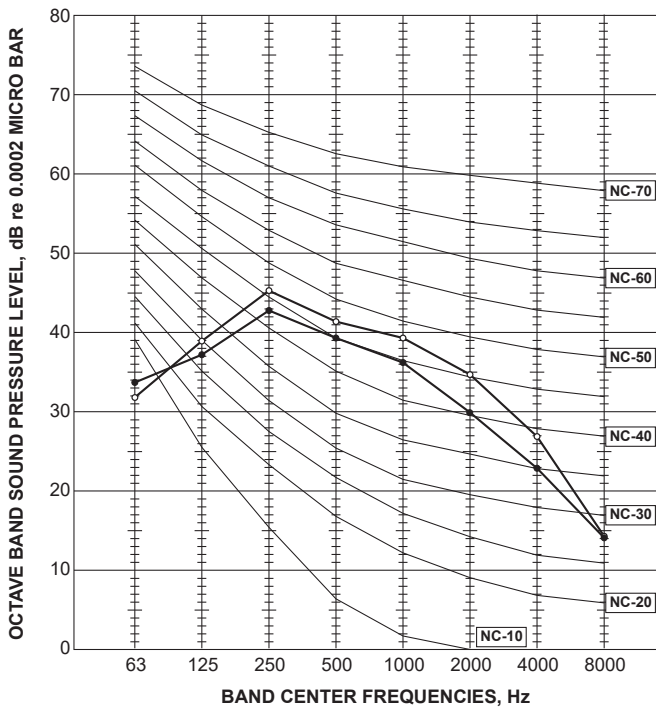

MFZ-KT35VG

FAN SPEED	FUNCTION	SPL(dB(A))	LINE
Super High	COOLING	41	●—●
	HEATING	44	○—○

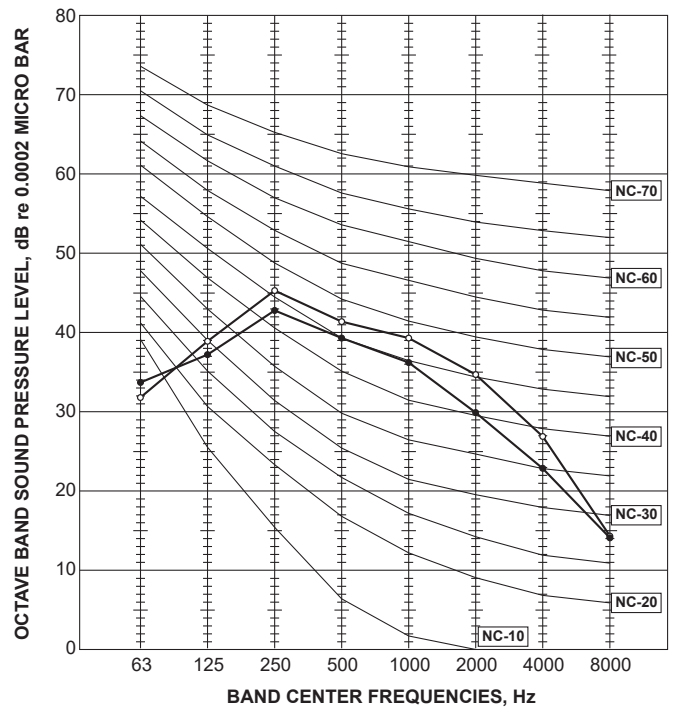

MFZ-KT50VG

FAN SPEED	FUNCTION	SPL(dB(A))	LINE
Super High	COOLING	48	●—●
	HEATING	49	○—○

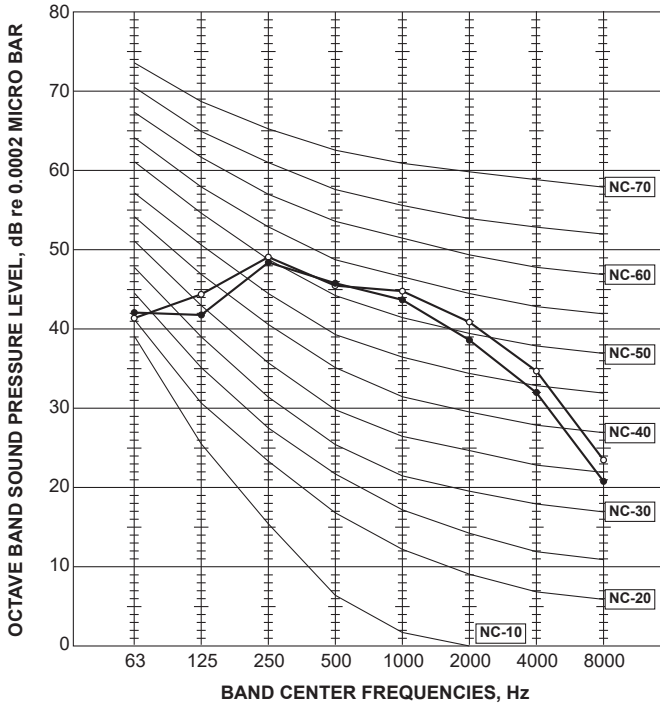

MFZ-KT60VG

FAN SPEED	FUNCTION	SPL(dB(A))	LINE
Super High	COOLING	53	●—●
	HEATING	51	○—○

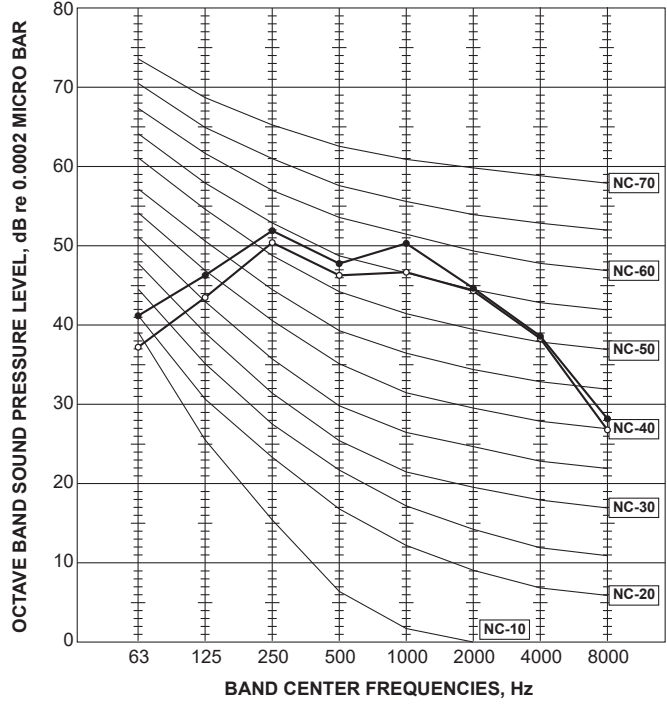

Test conditions

Cooling : Dry-bulb temperature 27 °C Wet-bulb temperature 19 °C
 Heating : Dry-bulb temperature 20 °C

MICROPHONE

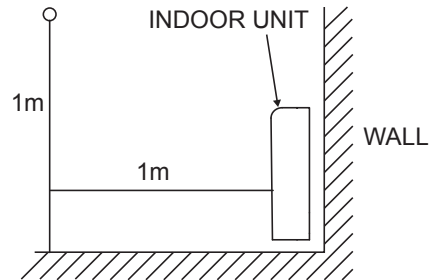

6

OUTLINES AND DIMENSIONS

MFZ-KT25VG MFZ-KT35VG MFZ-KT50VG MFZ-KT60VG

Unit: mm

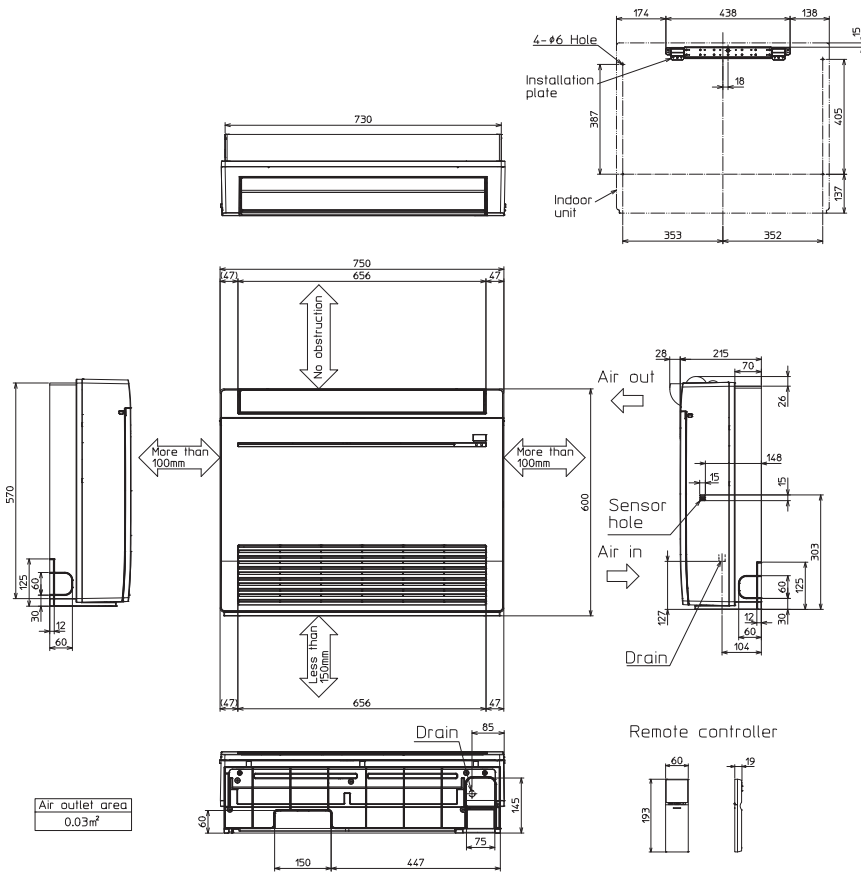

The position of gas pipe and liquid pipe

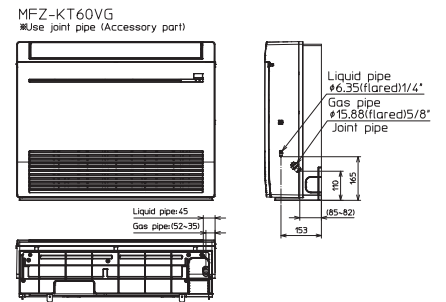
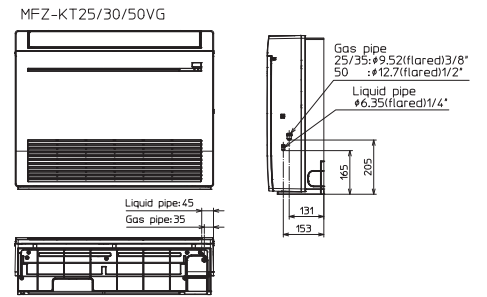

Remote controller

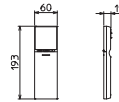

MFZ-KT25VG MFZ-KT35VG MFZ-KT50VG

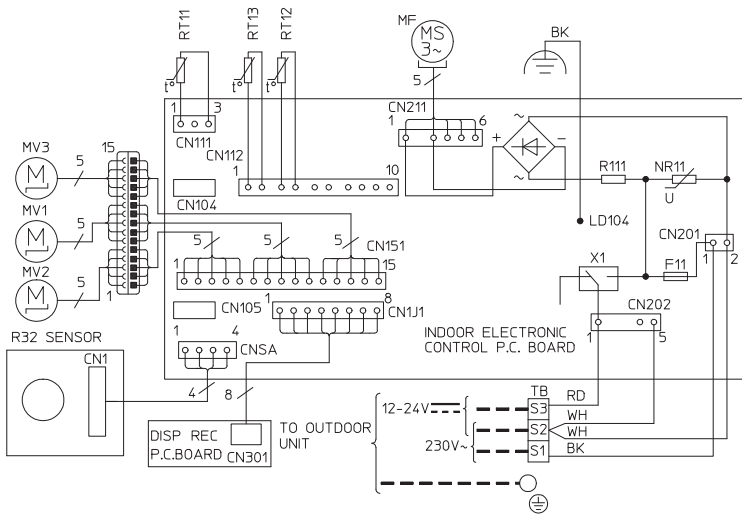

SYMBOL	NAME	SYMBOL	NAME
MF	FAN MOTOR	TB	TERMINAL BLOCK
MV1	HORIZONTAL VANE MOTOR (FRONT)	RT11	ROOM TEMP. THERMISTOR
MV2	HORIZONTAL VANE MOTOR (BACK)	RT12	COIL TEMP. THERMISTOR(MAIN1)
MV3	MULTI-FLOW VANE MOTOR	RT13	COIL TEMP. THERMISTOR(SUB)
F11	FUSE (T3.15AL250V)	NR11	VARISTOR
X1	RELAY	R111	RESISTOR

NOTES:

- About the outdoor side electric wiring refer to the outdoor unit electric wiring diagram for servicing.
- Use copper conductors only. (For field wiring)
- Symbols below indicate.

 : Terminal block

 : Connector



MFZ-KT60VG

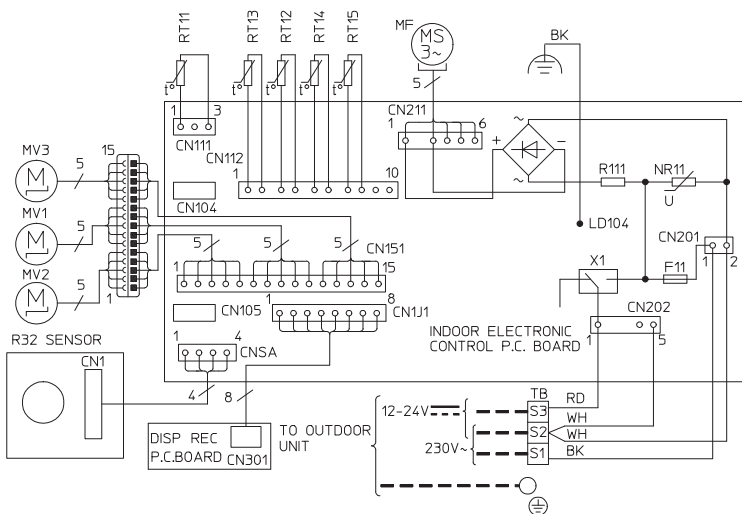

SYMBOL	NAME	SYMBOL	NAME
MF	FAN MOTOR	RT11	ROOM TEMP. THERMISTOR
MV1	HORIZONTAL VANE MOTOR (FRONT)	RT12	COIL TEMP. THERMISTOR(MAIN1)
MV2	HORIZONTAL VANE MOTOR (BACK)	RT13	COIL TEMP. THERMISTOR(SUB)
MV3	MULTI-FLOW VANE MOTOR	RT14	COIL TEMP. THERMISTOR(MAIN2)
F11	FUSE (T3.15AL250V)	RT15	COIL TEMP. THERMISTOR(MAIN3)
X1	RELAY	NR11	VARISTOR
TB	TERMINAL BLOCK	R111	RESISTOR

NOTES:

- About the outdoor side electric wiring refer to the outdoor unit electric wiring diagram for servicing.
- Use copper conductors only. (For field wiring)
- Symbols below indicate.

 : Terminal block

 : Connector



MFZ-KT25VG MFZ-KT35VG

Unit: mm

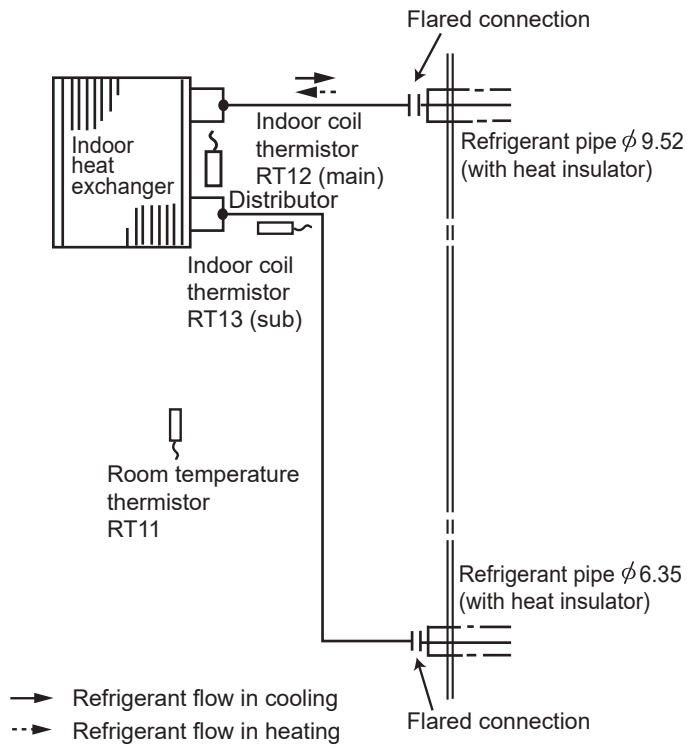

MFZ-KT50VG

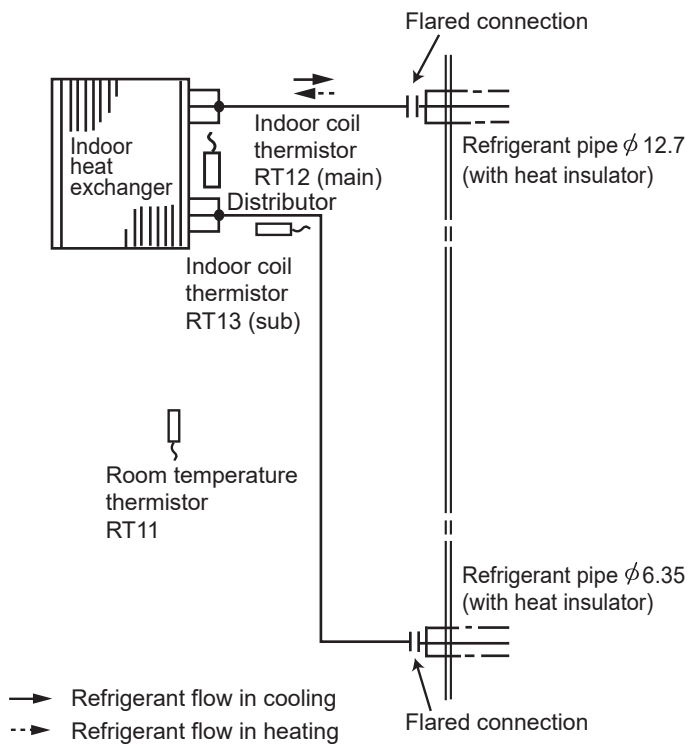

MFZ-KT60VG

Unit: mm

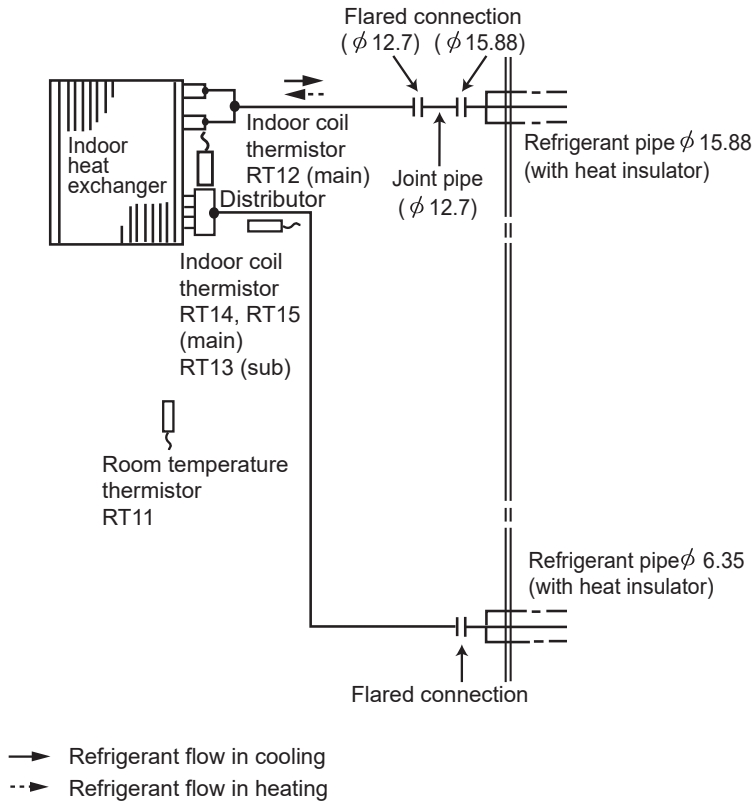

MFZ-KT25VG MFZ-KT35VG MFZ-KT50VG MFZ-KT60VG

9-1. TIMER SHORT MODE

- For service, the following set time can be shortened by bridging the timer short mode point on the electronic control P.C. board. (Refer to 11-7.)
- The set time for the ON/OFF timer can be reduced to 1 second for each minute.
- After the breaker is turned on, the time for starting the compressor, which normally takes 3 minutes, can be reduced to 1 minute. Restarting the compressor, which takes 3 minutes, cannot be reduced.

9-2. HOW TO SET REMOTE CONTROLLER EXCLUSIVELY FOR A PARTICULAR INDOOR UNIT

A maximum of 4 indoor units with wireless remote controllers can be used in a room.

To operate the indoor units individually with each remote controller, assign a number to each remote controller according to the number of the indoor unit.

This setting can be set only when all the following conditions are met:

- The remote controller is powered OFF.
- Weekly timer is not set.
- Weekly timer is not being edited.

1. How to modify the electronic control P.C. board

Turn OFF the power supply before modification. To assign a number to each indoor unit, cut off "JR05" and "JR06" on the electronic control P.C. board as shown in Table 1. (Refer to 11-7.)

Table 1

	JR05	JR06
Unit No. 1	No modification	No modification
Unit No. 2	Cut off JR05	No modification
Unit No. 3	No modification	Cut off JR06
Unit No. 4	Cut off JR05	Cut off JR06

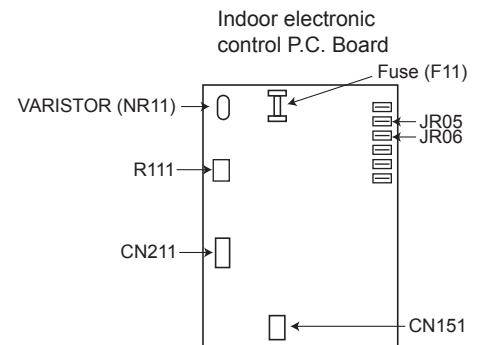

2. How to set the remote controller

- (1) Hold down **1~4** button on the remote controller for 2 seconds to enter the pairing mode.
- (2) Press **1~4** button again and assign a number to each remote controller.
Each press of **1~4** button advances the number in the following order: 1 → 2 → 3 → 4.
- (3) Press **EDIT/SEND SET** button to complete the pairing setting.

After the setting, turn ON the power supply and with the remote controller headed towards the indoor unit, press the STOP/OPERATE (OFF/ON) button. If 1 or 2 beeps is heard from the indoor unit, the setting is completed correctly. The remote controller that first sends a signal to an indoor unit will be regarded as the remote controller for the indoor unit.

Once they are set, the indoor unit will only receive the signal from the assigned remote controller afterwards.

9-3. AUTO RESTART FUNCTION

When the indoor unit is controlled with the remote controller, the operation mode, the set temperature, and the fan speed are memorized by the indoor electronic control P.C. board. "AUTO RESTART FUNCTION" automatically starts operation in the same mode just before the shutoff of the main power.

Operation

- ① If the main power has been cut, the operation settings remain.
- ② After the power is restored, the unit restarts automatically according to the memory.
(However, it takes at least 3 minutes for the compressor to start running.)

How to disable "AUTO RESTART FUNCTION"

- ① Turn off the main power for the unit.
- ② Cut the Jumper wire to JR77 on the indoor electronic control P.C. board. (Refer to 11-7.)

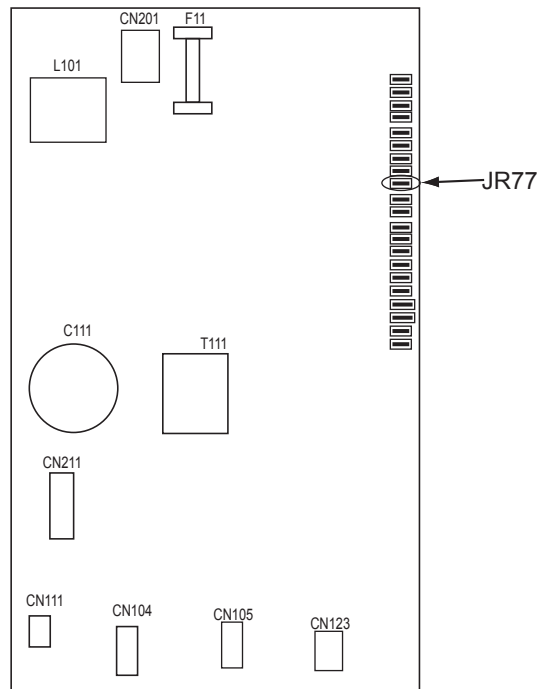

NOTE:

- The operation settings are memorized when 10 seconds have passed after the indoor unit was operated with the remote controller.
- If main power is turned OFF or a power failure occurs while AUTO START/STOP timer is active, the timer setting is cancelled.
- If the unit has been off with the remote controller before power failure, the auto restart function does not work as the power button of the remote controller is off.
- To prevent breaker OFF due to the rush of starting current, systematize other home appliance not to turn ON at the same time.
- When some air conditioners are connected to the same supply system, if they are operated before power failure, the starting current of all the compressors may flow simultaneously at restart.
Therefore, the special counter measures are required to prevent the main voltage-drop or the rush of the starting current by adding to the system that allows the units to start one by one.

MFZ-KT25VG MFZ-KT35VG MFZ-KT50VG MFZ-KT60VG

WIRELESS REMOTE CONTROLLER

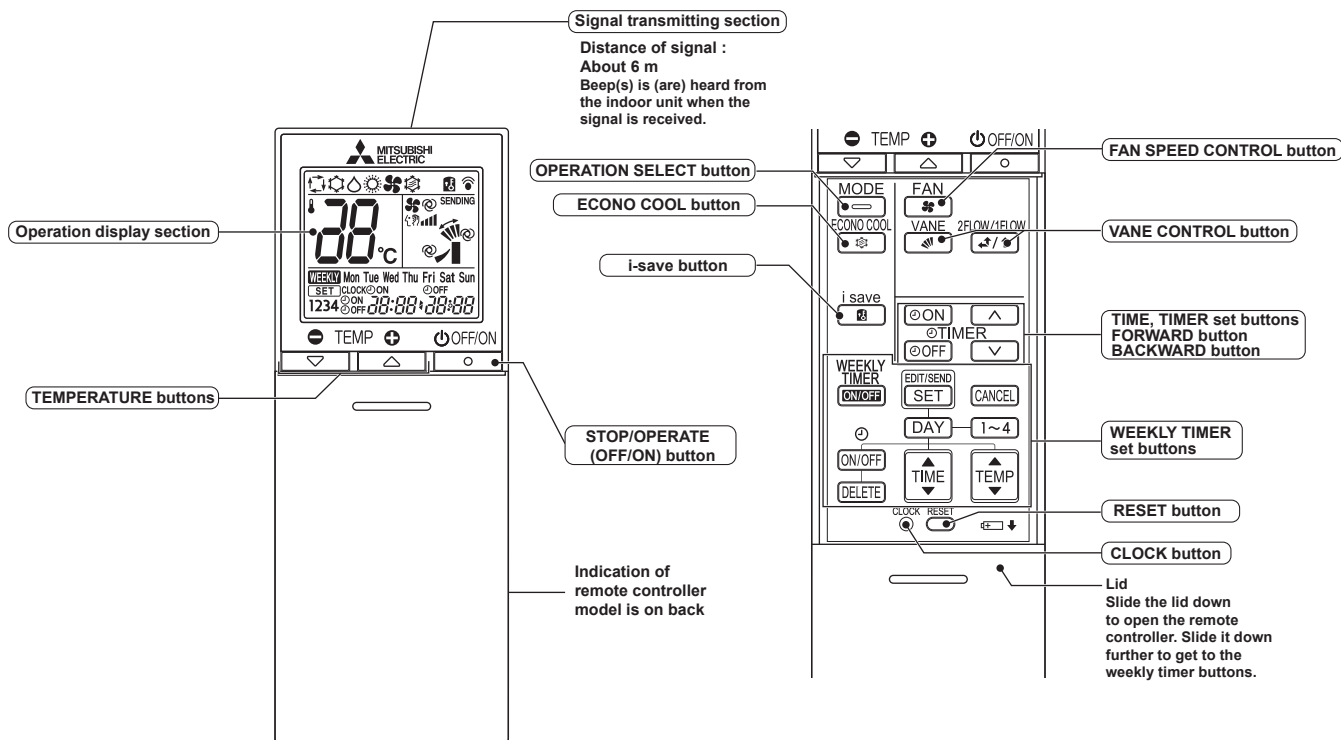

NOTE: Last setting will be stored after the unit is turned OFF with the remote controller. Indoor unit receives the signal of the remote controller with beeps.

INDOOR UNIT DISPLAY SECTION

Operation Indicator lamp

The operation indicator at the right side of the indoor unit indicates the operation state.

•The following indication applies regardless of shape of the indication.

Indication	Operation state	Room temperature
● ●	The unit is operating to reach the set temperature	About 2°C or more away from set temperature
● ○	The room temperature is approaching the set temperature	About 1 to 2°C from set temperature
● ☉	Standby mode (only during multi system operation)	—

● Lit
 ☉ Blinking
 ○ Not lit

10-1. COOL (☉) OPERATION

- (1) Press STOP/OPERATE (OFF/ON) button.
OPERATION INDICATOR lamp of the indoor unit turns on with a beep tone.
- (2) Select COOL mode with OPERATION SELECT button.
- (3) Press TEMPERATURE buttons TEMP ⊖ or ⊕ button to select the set temperature. The setting range is 16 - 31°C.

1. Coil frost prevention

The compressor operational frequency is controlled by the temperature of the indoor heat exchanger to prevent the coil from frosting.

When the temperature of indoor heat exchanger becomes too low, the coil frost prevention mode works.

The indoor fan operates at the set speed and the compressor stops. This mode continues until the temperature of indoor heat exchanger rises.

2. Low outside temperature operation

When the outside temperature is lower, low outside temperature operation starts, and the outdoor fan slows or stops.

3. Indoor fan speed control

When the thermostat turns OFF, the indoor fan operates at the setting fan speed.

10-2. DRY (△) OPERATION

- (1) Press STOP/OPERATE (OFF/ON) button.
OPERATION INDICATOR lamp of the indoor unit turns on with a beep tone.
- (2) Select DRY mode with OPERATION SELECT button.
- (3) The set temperature is determined from the initial room temperature.

1. Coil frost prevention

Coil frost prevention works the same way as that in COOL mode. (10-1.1.)

2. Low outside temperature operation

Low outside temperature operation works the same way as that in COOL mode. (10-1.2.)

3. Indoor fan speed control

Indoor fan speed control works the same way as that in COOL mode. (10-1.3.)

However in AUTO setting, the fan speed changes.

10-3. FAN (⚙) OPERATION

- (1) Press STOP/OPERATE (OFF/ON) button.
OPERATION INDICATOR lamp of the indoor unit turns on with a beep tone.
 - (2) Select FAN mode with OPERATION SELECT button.
 - (3) Select the desired fan speed. When AUTO, it becomes Low.
Only indoor fan operates.
Outdoor unit does not operate.
- NOTE:** Temperature cannot be set during FAN mode.

10-4. HEAT (☀) OPERATION

- (1) Press STOP/OPERATE (OFF/ON) button.
OPERATION INDICATOR lamp of the indoor unit turns on with a beep tone.
- (2) Select HEAT mode with OPERATION SELECT button.
- (3) Press TEMPERATURE buttons TEMP \ominus or \oplus button to select the set temperature. The setting range is 16 - 31°C.

1. Cold air prevention control

When the compressor is not operating or is starting, and the temperature of indoor heat exchanger and/or the room temperature is low or when defrosting is being done, the indoor fan will stop or rotate in Very Low speed.

2. High pressure protection

The compressor operational frequency is controlled by the temperature of the indoor heat exchanger to prevent the condensing pressure from increasing excessively.

When the temperature of indoor heat exchanger becomes too high, the high pressure protection works.

This mode continues until the temperature of indoor heat exchanger falls.

3. Defrosting

Defrosting starts when the temperature of outdoor heat exchanger becomes too low.

The compressor stops once, the indoor/outdoor fans stop, the 4-way valve reverses, and the compressor re-starts.

This mode continues until the temperature of outdoor heat exchanger rises or the fixed time passes.

10-5. AUTO CHANGE OVER ... AUTO MODE OPERATION

Once set temperature is set, unit operation is switched automatically between COOL and HEAT operation.

1. Mode selection

(1) Initial mode

At first indoor unit operates only indoor fan with outdoor unit OFF for 3 minutes to detect present room temperature. Following the conditions below, operation mode is selected.

① If the room temperature thermistor RT11 reads more than set temperature, COOL mode is selected.

② If the room temperature thermistor RT11 reads set temperature or less, HEAT mode is selected.

(2) Mode change

In case of the following conditions the operation mode is changed.

① COOL mode changes to HEAT mode when 15 minutes have passed with the room temperature 2 degrees below the set temperature.

② HEAT mode changes to COOL mode when 15 minutes have passed with the room temperature 2 degrees below the set temperature.

In the other cases than the above conditions, the present operation mode is continued.

NOTE 1: Mode selection is performed when multi standby (refer to **NOTE 2**) is released and the unit starts operation with ON-timer.

NOTE 2: If 2 or more indoor units are operating in multi system, there might be a case that the indoor unit, which is operating in AUTO (□), cannot change over the other operating mode (COOL ↔ HEAT) and becomes a state of standby.

NOTE 3: At the beginning of AUTO mode, the airflow direction and the fan speed are set to AUTO and the air outlet selection is set to 2 FLOW.

10-6. AUTO VANE OPERATION

1. Horizontal vane (Horizontal vane/Multi-flow vane)

(1) Vane motor drive

These models are equipped with a stepping motors for the horizontal vanes. The rotating direction, speed, and angle of the motor are controlled by pulse signals (approximately 12 V) transmitted from indoor microprocessor.

(2) The horizontal vane angle and mode change as follows by pressing VANE CONTROL () button.



(3) Positioning

The vane presses the vane stopper once to confirm the standard position and then moves to the set angle. Confirming of standard position is performed in case of the followings.

- The power supply turns on.
- The operation starts or finishes (including timer operation).
- The test run starts.
- The multi-standby starts or finishes.
- Every time the vane has swung more than the specified numbers of times.
- The horizontal vane automatically moves in certain intervals to determine its position, and then it returns to set position.
- The vane operates for the dew prevention.

(4) Air outlet selection

The air outlet(s) can be selected by pressing to VANE CONTROL () button.

When 2 FLOW is selected, air blows from the top and the front of the unit. When 1 FLOW is selected, air blows only from the top of the unit.

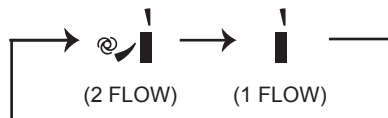

The multi-flow vane is automatically set to the appropriate position.

In HEAT, the multi-flow vane automatically changes its position according to the indoor fan speed.

Even if 2 FLOW is selected, air will blow only from the top of the unit in the following conditions:

- During COOL/DRY: The room temperature is close to set temperature.
The air conditioner has operated for 0.5 to 1 hour.
- During HEAT: The airflow temperature is low. (During defrosting operation, start of operation, etc.)

NOTE:

Movement at the start of the 2 FLOW operation

- COOL/DRY, HEAT: It takes 0.5 to 1 minute to start the 2 FLOW operation.
- HEAT: When cold air blows out from the air outlet, the multi-flow vane may stop moving for up to 10 minutes to make and blow out warm air.

(5) VANE AUTO (Ⓢ) mode

In VANE AUTO mode, the microprocessor automatically determines the vane angle to make the optimum room temperature distribution.

In COOL, DRY and FAN operation

2 FLOW: Vane angle is fixed to position 2.



1 FLOW: Vane angle is fixed to position 1.



In HEAT operation

2 FLOW: Vane angle is fixed to position 2.



1 FLOW: Vane angle is fixed to position 3.



(6) STOP (operation OFF) and ON TIMER standby

In the following cases, the horizontal vane returns to the closed position.

- (a) When STOP/OPERATE (OFF/ON) button is pressed (POWER OFF).
- (b) When the operation is stopped by the emergency operation.
- (c) When ON TIMER is ON standby.

(7) Dew prevention

During COOL or DRY operation with the vane angle at Angle 3 or 4 when the compressor cumulative operation time exceeds 1 hour, the vane angle automatically changes to Angle 1 for dew prevention.

(8) SWING (↕) mode

By selecting SWING mode with VANE CONTROL button, the horizontal vanes swing vertically.

The remote controller displays "↕". SWING mode is cancelled when VANE CONTROL button is pressed once again.

(9) Cold air prevention in HEAT operation

The horizontal vane position is set to Upward.

(10) ECONO COOL (⚡) operation (ECONOMical operation)

When ECONO COOL button is pressed in COOL mode, set temperature is automatically set 2°C higher by the microprocessor. However, the temperature on the LCD screen on the remote controller is not changed. Also the horizontal vane swings in various cycle.

SWING operation makes you feel cooler than set temperature. So, even though the set temperature is higher, the air conditioner can keep comfort. As a result, energy can be saved.

To cancel this operation, select a different mode or press one of the following buttons in ECONO COOL operation: ECONO COOL, VANE CONTROL button.

10-7. TIMER OPERATION

1. How to set the time

- (1) Check that the current time is set correctly.

NOTE: Timer operation will not work without setting the current time. Initially "0:00" blinks at the current time display of TIME MONITOR, so set the current time correctly with CLOCK button.

How to set the current time

- (a) Press the CLOCK button.
(b) Press the TIME SET buttons ($\square\wedge$ and $\square\vee$) to set the current time.
- Each time FORWARD button ($\square\wedge$) is pressed, the set time increases by 1 minute, and each time BACKWARD button ($\square\vee$) is pressed, the set time decreases by 1 minute.
 - Pressing those buttons longer, the set time increases/decreases by 10 minutes.
- (c) Press the CLOCK set button.
(2) Press STOP/OPERATE (OFF/ON) button to start the air conditioner.
(3) Set the time of timer.

ON timer setting

- (a) Press ON TIMER button (ON) during operation.
(b) Set the time of the timer using TIME SET buttons ($\square\wedge$ and $\square\vee$). ※

OFF timer setting

- (a) Press OFF TIMER button (OFF) during operation.
(b) Set the time of the timer using TIME SET buttons ($\square\wedge$ and $\square\vee$). ※
- ※ Each time FORWARD button ($\square\wedge$) is pressed, the set time increases by 10 minutes: each time BACKWARD button ($\square\vee$) is pressed, the set time decreases by 10 minutes.

2. To release the timer

To release ON timer, press ON TIMER button (ON).

To release OFF timer, press OFF TIMER button (OFF).

TIMER is cancelled and the display of set time disappears.

PROGRAM TIMER

- OFF timer and ON timer can be used in combination. The set time that is reached first will operate first.
- "◀" and "▶" display shows the order of OFF timer and ON timer operation.

(Example 1) The current time is 8:00 PM.

The unit turns off at 11:00 PM, and on at 6:00 AM.

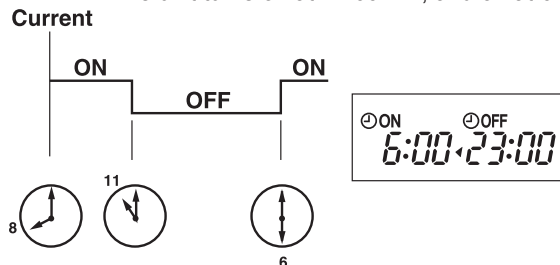

(Example 2) The current time is 11:00 AM.

The unit turns on at 5:00 PM, and off at 9:00 PM.

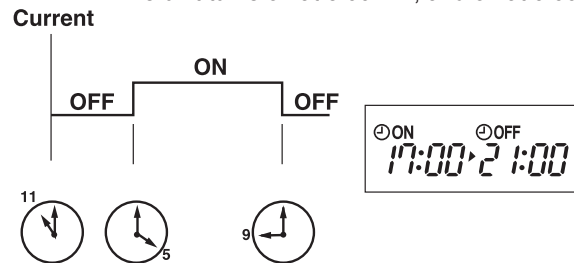

NOTE: If the main power is turned OFF or a power failure occurs while ON/OFF timer is active, the timer setting is cancelled. As these models are equipped with an auto restart function, the air conditioner starts operating with timer cancelled when power is restored.

10-8. WEEKLY TIMER OPERATION

- A maximum of 4 ON or OFF timers can be set for individual days of the week.
- A maximum of 28 ON or OFF timers can be set for a week.

E.g. : Runs at 24°C from waking up to leaving home, and runs at 27°C from getting home to going to bed on weekdays.
Runs at 27°C from waking up late to going to bed early on weekends.

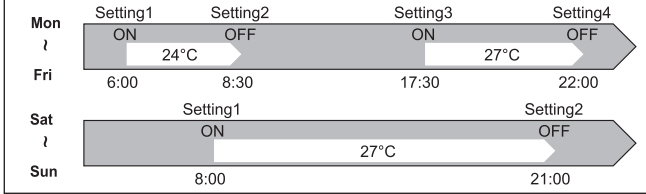

NOTE:

- The simple ON/OFF timer setting is available while the weekly timer is on. In this case, the ON/OFF timer has priority over the weekly timer; the weekly timer operation will start again after the simple ON/OFF timer is complete.
- When the weekly timer is set, temperature cannot be set to 10°C.
- The weekly timer operation and i-save operation cannot be used together.

1. How to set the weekly timer

* Make sure that the current time and day are set correctly.

(1) Press **EDIT/SEND** button to enter the weekly timer setting mode.

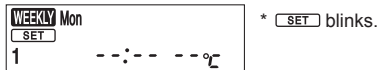

(2) Press **DAY** and **1~4** buttons to select setting day and number.

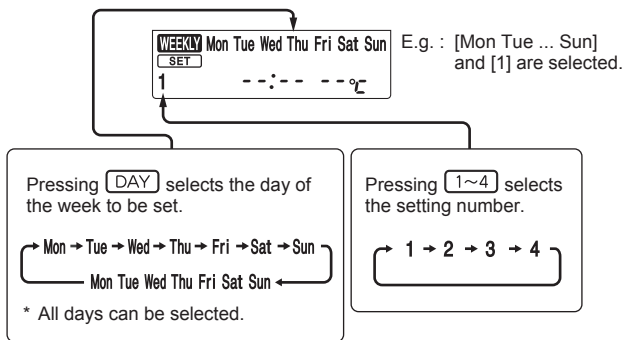

(3) Press **ON/OFF**, **TIME**, and **TEMP** buttons to set ON/OFF, time, and temperature.

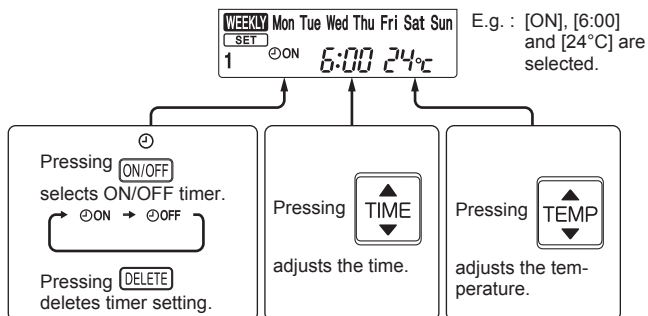

* Hold down the button to change the time quickly.

* The temperature can be set between 16 °C and 31 °C at weekly timer.





Press **DAY** and **1~4** buttons to continue setting the timer for other days and/or numbers.



(4) Press  button to complete and transmit the weekly timer setting.





*  which was blinking goes out, and the current time will be displayed.

NOTE:

- Press  button to transmit the setting information of weekly timer to the indoor unit. Point the remote controller toward the indoor unit for 3 seconds.
- When setting the timer for more than one day of the week or one number,  button does not have to be pressed per each setting. Press  button once after all the settings are complete. All the weekly timer settings will be saved.
- Press  button to enter the weekly timer setting mode, and press and hold  button for 5 seconds to erase all weekly timer settings. Point the remote controller toward the indoor unit.

(5) Press  button to turn the weekly timer ON. ( lights.)

•When the weekly timer is ON, the day of the week whose timer setting is complete, will light.

Press  button again to turn the weekly timer OFF. ( goes out.)

NOTE:

The saved settings will not be cleared when the weekly timer is turned OFF.

2. Checking weekly timer setting

(1) Press  button to enter the weekly timer setting mode.

* blinks.

(2) Press  or  buttons to view the setting of the particular day or number.

(3) Press  button to exit the weekly timer setting.

10-9. i-save (i) OPERATION

1. How to set i-save operation

- (1) Press STOP/OPERATE (OFF/ON) button.
- (2) Select COOL or HEAT mode.
- (3) Press i-save button.
- (4) Set the temperature, fan speed, airflow direction, and 2 FLOW/1 FLOW for i-save operation.

NOTE:

- i-save operation cannot be selected during DRY, FAN or AUTO mode operation.
- The setting range of HEAT mode i-save operation is 10°C and 16 - 31°C.
- 2 groups of setting can be saved. (One for COOL, one for HEAT)
- i-save operation and the weekly timer operation cannot be used together.

2. How to cancel operation

- Press i-save button again.
- i-save operation can also be cancelled by pressing OPERATION SELECT button to change the operation mode. The same setting is selected from the next time by simply pressing i-save button.

10-10. EMERGENCY/TEST OPERATION

In the case of test run operation or emergency operation, use EMERGENCY OPERATION switch on the right side of the indoor unit. Emergency operation is available when the remote controller is missing or has failed, or when the batteries in the remote controller are running down. The unit will start and OPERATION INDICATOR lamp will light up.

The first 30 minutes of operation is the test run operation. This operation is for servicing. The indoor fan runs at High speed and the temperature control does not work. In COOL MODE, the air outlet selection is set to 2 FLOW during the test run operation.

After 30 minutes of test run operation, the system shifts to EMERGENCY COOL/HEAT MODE with a set temperature of 24°C. The fan speed shifts to Medium.

The coil frost prevention works even in the test run or the emergency operation.

In the test run or emergency operation, the horizontal vane operates in VANE AUTO (@) mode.







Emergency operation continues until EMERGENCY OPERATION switch is pressed once or twice or the unit receives any signal from the remote controller. In the latter case, normal operation will start.



NOTE: Do not press EMERGENCY OPERATION switch during normal operation.

Operation mode	COOL/HEAT
Set temperature	24°C
Fan speed	Medium
Horizontal vane	Auto
Air outlet	2 FLOW

The operation mode is indicated by the Operation Indicator lamp as following

Operation Indicator lamp

EMERGENCY COOL  
 EMERGENCY HEAT  
 STOP  

 Lit
 Not lit

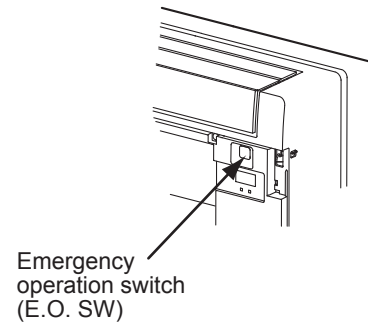

10-11. 3-MINUTE TIME DELAY OPERATION

When the system turns OFF, compressor will not restart for 3 minutes as 3-minute time delay function operates to protect compressor from overload.

MFZ-KT25VG MFZ-KT35VG MFZ-KT50VG MFZ-KT60VG

11-1. CAUTIONS ON TROUBLESHOOTING

1. Before troubleshooting, check the following

- 1) Check the power supply voltage.
- 2) Check the indoor/outdoor connecting wire for miswiring.

2. Take care of the following during servicing

- 1) Before servicing the air conditioner, be sure to turn OFF the main unit first with the remote controller, and then after confirming the horizontal vane is closed, turn OFF the breaker.
- 2) Be sure to turn OFF the power supply before removing the front panel, the cabinet, the top panel, and the P.C. board.
- 3) When removing the P.C. board, hold the edge of the board with care NOT to apply stress on the components.
- 4) When connecting or disconnecting the connectors, hold the connector housing. DO NOT pull the lead wires.

<Incorrect>



Lead wiring

<Correct>



Connector housing

3. Troubleshooting procedure

- 1) Check if the OPERATION INDICATOR lamp on the indoor unit is blinking ON and OFF to indicate an abnormality. To make sure, check how many times the OPERATION INDICATOR lamp is blinking ON and OFF before starting service work.
- 2) Before servicing, check that the connector and terminal are connected properly.
- 3) When the electronic control P.C. board seems to be defective, check the copper foil pattern for disconnection and the components for bursting and discoloration.
- 4) When troubleshooting, Refer to 11-2, 11-3 and 11-4.

4. How to replace batteries

Weak batteries may cause the remote controller malfunction.

In this case, replace the batteries to operate the remote controller normally.

- ① Remove the front lid and insert batteries. Then reattach the front lid.

- ② Press RESET button with a thin instrument, and then use the remote controller.

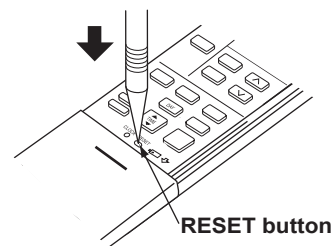
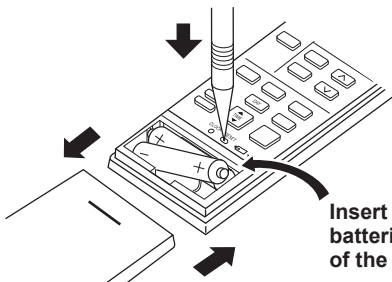

- NOTE:**
1. If RESET button is not pressed, the remote controller may not operate correctly.
 2. This remote controller has a circuit to automatically reset the microprocessor when batteries are replaced. This function is equipped to prevent the microprocessor from malfunctioning due to the voltage drop caused by the battery replacement.
 3. Do not use the leaking batteries.

5. Description of multi system air conditioner

INDOOR UNIT: MFZ-KT-VG OUTDOOR UNIT: MXZ series

The multi system outdoor unit can be connected to 2 or more indoor units.

- The units do not operate and the operation indicator lamp blinks as shown in the figure below when the total capacity of the indoor units exceeds the capacity of the outdoor unit. Do not connect the indoor units beyond the outdoor unit capacity.
- When operating the 2 or more indoor units connected to a multi system outdoor unit, set all the indoor units to the same operation mode. If the COOL and the HEAT modes are selected for those indoor units, the indoor unit which has started operation first has a priority. The other indoor units set to the different operation mode later do not start operation and the operation indicator lamp blinks as shown in the figure below.

OPERATION INDICATOR

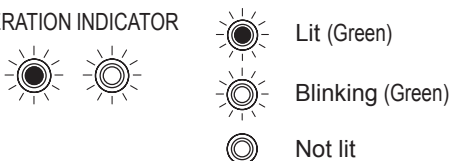

- When the indoor units start operation while the defrosting of the outdoor unit is being performed, it takes a few minutes (up to 10 minutes) to blow out warm air.
- In HEAT operation, even though the indoor unit is not running, the room may get warm or the sound of refrigerant flowing may be heard. This is not a malfunction. They happen because the refrigerant is continuously flowing inside the unit.

11-2. FAILURE MODE RECALL FUNCTION

Outline of the function

This air conditioner can memorize the abnormal condition which has occurred once.

Even though OPERATION INDICATOR lamp indication listed on the troubleshooting check table (11-4.) disappears, the memorized failure details can be recalled.

This mode is very useful when the unit needs to be repaired for the abnormality which does not recur.

1. Flow chart of failure mode recall function for the indoor/outdoor unit

Operational procedure

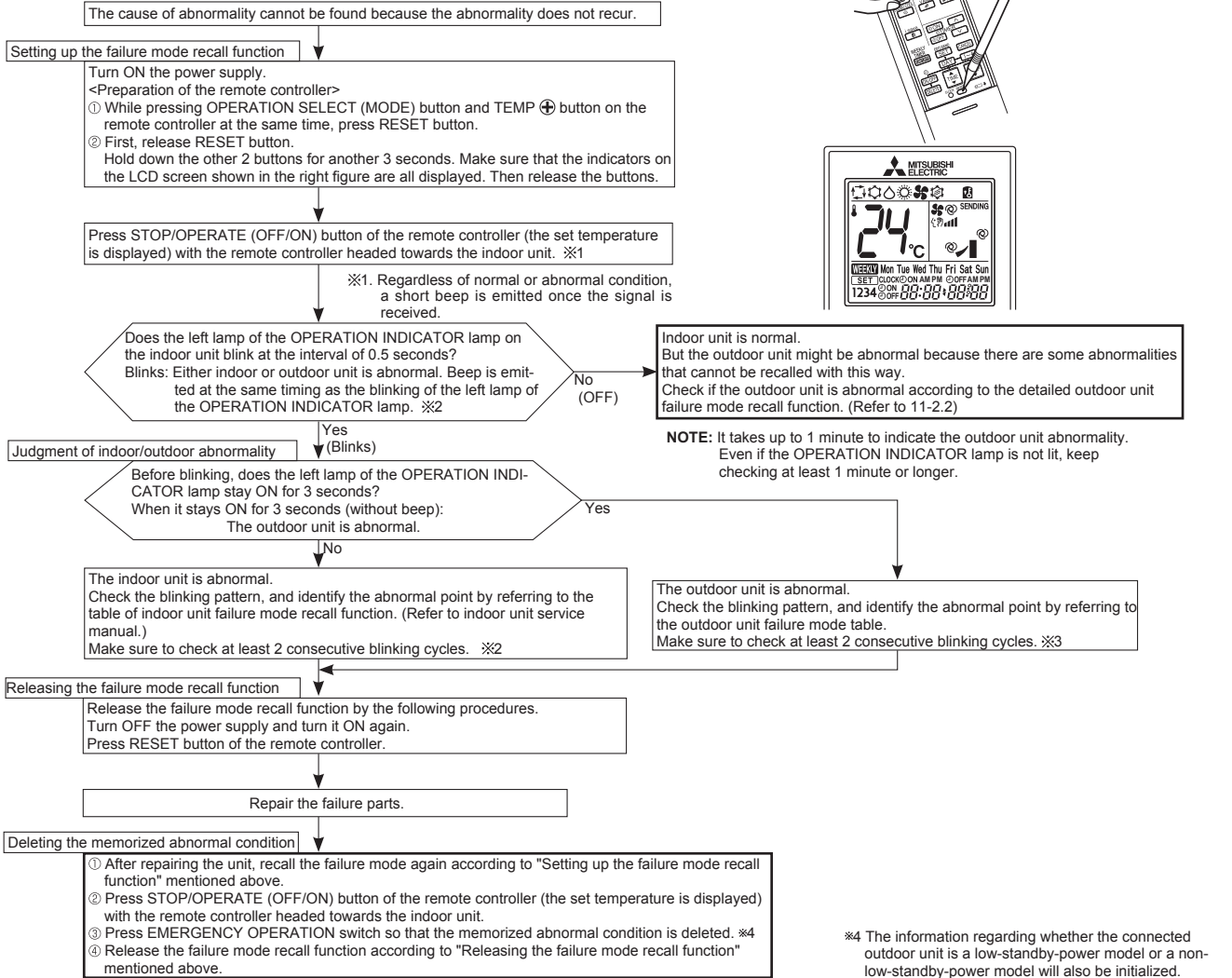

NOTE: 1. Make sure to release the failure mode recall function after it is set up, otherwise the unit cannot operate properly.
 2. If the abnormal condition is not deleted from the memory, the last abnormal condition is kept memorized.

※2. Blinking pattern when the indoor unit is abnormal:

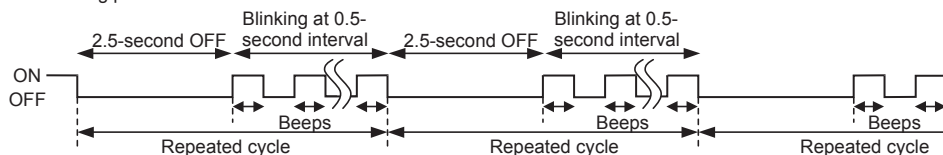

※3. Blinking pattern when the outdoor unit is abnormal:

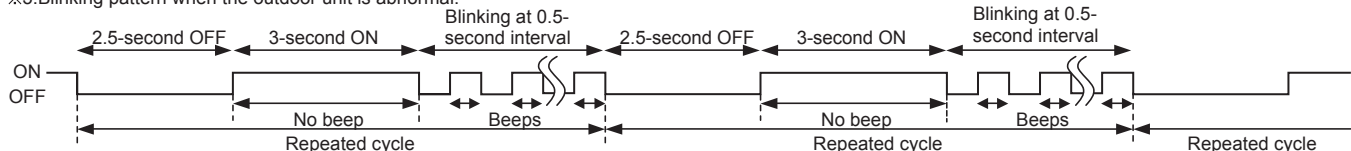

2. Table of indoor unit failure mode recall function

NOTE: Blinking patterns of this mode differs from the ones of Troubleshooting check table (10-4.).

Left lamp of OPERATION INDICATOR lamp	Right lamp of OPERATION INDICATOR lamp	Abnormal point (Failure mode)	Condition	Remedy
Not lit	Not lit	Normal	—	—
1-time blink every 0.5-second	Not lit	Room temperature thermistor	The room temperature thermistor short or open circuit is detected every 8 seconds during operation.	Refer to the characteristics of the room temperature thermistor (11-7.).
2-time blink 2.5-second OFF	Not lit	Indoor coil thermistor (Main 1, 2 and sub)	The indoor coil thermistor short or open circuit is detected every 8 seconds during operation.	Refer to the characteristic of the main indoor coil thermistors 1 and 2 and the sub indoor coil thermistor (11-7.).
3-time blink 2.5-second OFF	Not lit	Serial signal error	The serial signal from the outdoor unit is not received for a maximum of 6 minutes.	Refer to 11-6. ⑥ "How to check miswiring and serial signal error".
11-time blink 2.5-second OFF	Not lit	Indoor fan motor (Upper)	The rotational frequency feedback signal is not emitted during 12-second the indoor fan operation.	Refer to 11-6 ④ "Check of indoor fan motor.
12-time blink 2.5-second OFF	Not lit	Indoor control system	It cannot properly read data in the nonvolatile memory of the indoor electronic control P.C. board.	Replace the indoor electronic control P.C. board.
13-time blink 2.5-second OFF	Not lit	Indoor coil thermistor (Main 3)	The indoor coil thermistor short or open circuit is detected every 8 seconds during operation.	Refer to the characteristic of the main indoor coil thermistor 3 (11-7.).

11-3. INSTRUCTION OF TROUBLESHOOTING

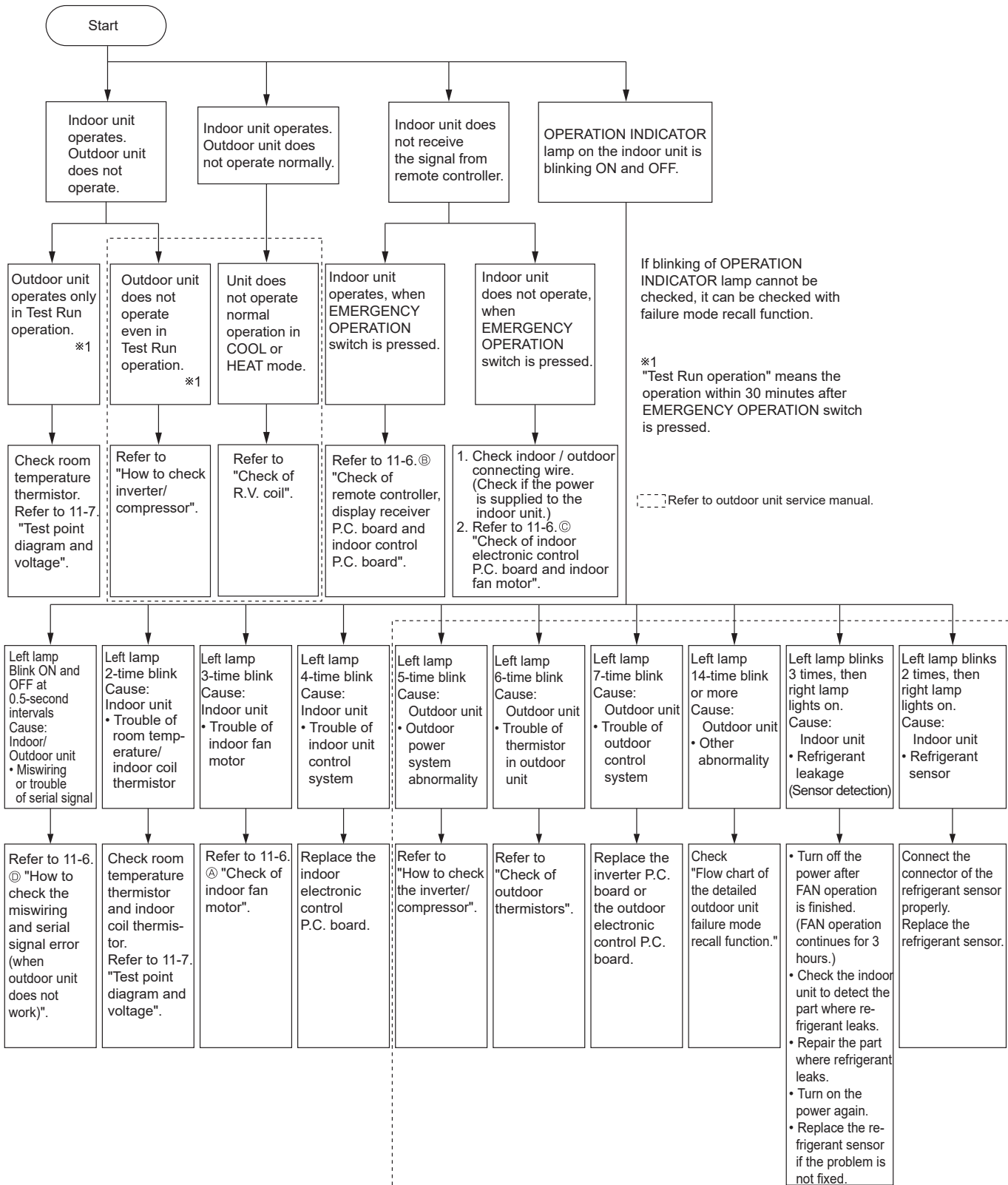

11-4. TROUBLESHOOTING CHECK TABLE

Before taking measures, make sure that the symptom reappears for accurate troubleshooting.

When the indoor unit has started operation and detected an abnormality of the following condition (the first detection after the power ON), the indoor fan motor turns OFF and OPERATION INDICATOR lamp blinks.

OPERATION INDICATOR



No.	Abnormal point	Operation indicator lamp	Symptom	Condition	Remedy
1	Miswiring or serial signal	Left lamp blinks. 0.5-second ON ●○●○●○●○ 0.5-second OFF	Indoor unit and outdoor unit do not operate.	The serial signal from the outdoor unit is not received for a maximum of 6 minutes. The indoor unit is connected to a low-standby-power model after once connected to a non-low-standby-power model.	<ul style="list-style-type: none"> Refer to 11-6. Ⓓ "How to check miswiring and serial signal error". Refer to NOTE.
2	Indoor coil thermistor Room temperature thermistor	Left lamp blinks. 2-time blink ●○●○●○●○●○●○ 2.5-second OFF	Indoor unit and outdoor unit do not operate.	The indoor coil or the room temperature thermistor is short or open circuit.	<ul style="list-style-type: none"> Refer to the characteristics of indoor coil thermistor, and the room temperature thermistor on 11-7.
3	Indoor fan motor	Left lamp blinks. 3-time blink ●○●○●○●○●○●○●○ 2.5-second OFF	Indoor unit and outdoor unit do not operate.	The rotational frequency feedback signal is not emitted during the indoor fan operation.	<ul style="list-style-type: none"> Refer to 11-6. Ⓓ "Check of indoor fan motor".
4	Indoor control system	Left lamp blinks. 4-time blink ●○●○●○●○●○●○●○ 2.5-second OFF	Indoor unit and outdoor unit do not operate.	It cannot properly read data in the nonvolatile memory of the indoor electronic control P.C. board.	<ul style="list-style-type: none"> Replace the indoor electronic control P.C. board.
5	Outdoor power system	Left lamp blinks. 5-time blink ●○●○●○●○●○●○●○●○ 2.5-second OFF	Indoor unit and outdoor unit do not operate.	It consecutively occurs 3 times that the compressor stops for overcurrent protection or startup failure protection within 1 minute after startup.	<ul style="list-style-type: none"> Refer to "Check of inverter/compressor". Refer to the outdoor unit service manual. Check the stop valve.
6	Outdoor thermistors	Left lamp blinks. 6-time blink ●○●○●○●○●○●○●○●○ 2.5-second OFF	Indoor unit and outdoor unit do not operate.	The outdoor thermistors short or open circuit during the compressor operation.	<ul style="list-style-type: none"> Refer to "Check of outdoor thermistor". Refer to the outdoor unit service manual.
7	Outdoor control system	Left lamp blinks. 7-time blink ●○●○●○●○●○●○●○●○ 2.5-second OFF	Indoor unit and outdoor unit do not operate.	It cannot properly read data in the nonvolatile memory of the inverter P.C. board or the outdoor electronic control P.C. board.	<ul style="list-style-type: none"> Replace the inverter P.C. board or the outdoor electronic control P.C. board. Refer to the outdoor unit service manual.
8	Other abnormality	Left lamp blinks. 14-time blink or more ●○●○●○●○●○●○●○●○●○●○●○●○●○ 2.5-second OFF	Indoor unit and outdoor unit do not operate.	An abnormality other than above mentioned is detected.	<ul style="list-style-type: none"> Check the stop valve. Check the 4-way valve. Check the abnormality in detail using the failure mode recall function. Refer to the outdoor unit service manual.
9	Outdoor control system	Left lamp lights up ●	Outdoor unit does not operate.	It cannot properly read data in the nonvolatile memory of the inverter P.C. board or the outdoor electronic control P.C. board.	<ul style="list-style-type: none"> Check the blinking pattern of the LED on the inverter P.C. board or the outdoor electronic control P.C. board.
10	Refrigerant leakage (Sensor detection)	Left lamp blinks 3 times, then right lamp lights on. Left lamp ●○●○●○●○●○●○ 3.0-second OFF Right lamp ○○●○●○●○●○●○ 3.0-second ON	<ul style="list-style-type: none"> FAN operation starts, and the air blows upward from the horizontal vane. It cannot be controlled by the remote controller. 	<ul style="list-style-type: none"> ① Refrigerant leaks from the piping or the heat exchanger in the indoor unit. ② The following items are used around the indoor unit. <ul style="list-style-type: none"> Spray (LP gas including Freon, and whose main ingredient is propane and butane) Aerosol insecticide (including ethanol) Air spray painting (including dichloromethane) Charcoal (charcoal fire) Chemicals (such as ethanol) 	<ul style="list-style-type: none"> Turn off the power after FAN operation is finished. (FAN operation continues for 3 hours.) Check the indoor unit to detect the part where refrigerant leaks. Repair the part where refrigerant leaks. Turn on the power again. Replace the refrigerant sensor if the problem is not fixed.
11	Refrigerant sensor	Left lamp blinks 2 times, then right lamp lights on. Left lamp ●○●○●○●○●○●○ 3.0-second OFF Right lamp ○○●○●○●○●○●○ 3.0-second ON	Indoor unit and outdoor unit do not operate.	The refrigerant sensor mounted on the indoor unit does not work. The refrigerant sensor is not connected properly or the wire is broken.	<ul style="list-style-type: none"> Connect the connector of the refrigerant sensor properly. Replace the refrigerant sensor.

NOTE: The indoor unit may have been connected to a non-low-standby-power model outdoor unit. To use a low-standby-power model, clear the error history by referring to "Deleting the memorized abnormal condition" described in 11-2.1. When the error history is being cleared, the connection information also will be initialized. The indoor unit will be compatible with a low-standby-power model after initialization. If the operation indicator lamp continues to blink as shown in No.1 after the procedure, refer to 11-6. Ⓓ "How to check miswiring and serial error".

OPERATION INDICATOR

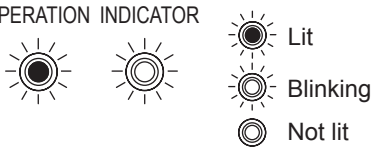

No.	Abnormal point	Operation indicator lamp	Symptom	Condition	Remedy
1	MXZ type Operation mode setting	<p>Right lamp blink</p> <p>2.5-second OFF</p>	Outdoor unit operates but indoor unit does not operate.	When the operation mode of the each indoor unit is differently set to COOL (includes DRY) and HEAT at the same time, the operation mode of the indoor unit that has operated first has the priority.	<ul style="list-style-type: none"> Select the same operation mode for all the units. Refer to the outdoor unit service manual.

11-5. TROUBLE JUDGEMENT CRITERIA OF MAIN PARTS
MFZ-KT25VG MFZ-KT35VG MFZ-KT50VG MFZ-KT60VG

Part name	Check method and criteria	Figure				
Room temperature thermistor (RT11)	Measure the resistance with a tester.					
Indoor coil thermistor (RT12 (MAIN 1), RT13 (SUB) RT14 (MAIN 2), RT15 (MAIN 3))	Refer to 11-7. "Test point diagram and voltage", "Indoor electronic control P.C. board", for the chart of thermistor.					
Indoor fan motor (MF)	Check 11-6. ④ "Check of indoor fan motor" and ⑤ "Check of indoor electronic control P.C. board and indoor fan motor".					
Horizontal vane motor (MV1) FRONT	Measure the resistance between the terminals with a tester. (Part temperature: 10°C ~ 30°C) <table border="1" style="margin-left: 20px;"> <tr> <td>Color of the lead wire</td> <td>Normal</td> </tr> <tr> <td>BRN-other one (250 Ω)</td> <td>219 Ω ~ 273 Ω</td> </tr> </table>	Color of the lead wire	Normal	BRN-other one (250 Ω)	219 Ω ~ 273 Ω	
Color of the lead wire	Normal					
BRN-other one (250 Ω)	219 Ω ~ 273 Ω					
Horizontal vane motor (MV2) BACK	Measure the resistance between the terminals with a tester. (Part temperature: 10°C ~ 30°C) <table border="1" style="margin-left: 20px;"> <tr> <td>Color of the lead wire</td> <td>Normal</td> </tr> <tr> <td>BRN-other one (250 Ω)</td> <td>219 Ω ~ 273 Ω</td> </tr> </table>	Color of the lead wire	Normal	BRN-other one (250 Ω)	219 Ω ~ 273 Ω	
Color of the lead wire	Normal					
BRN-other one (250 Ω)	219 Ω ~ 273 Ω					
Multi-flow vane motor (MV3)	Measure the resistance between the terminals with a tester. (Part temperature: 10°C ~ 30°C) <table border="1" style="margin-left: 20px;"> <tr> <td>Color of the lead wire</td> <td>Normal</td> </tr> <tr> <td>BRN-other one (350 Ω)</td> <td>306 Ω ~ 382 Ω</td> </tr> </table>	Color of the lead wire	Normal	BRN-other one (350 Ω)	306 Ω ~ 382 Ω	
Color of the lead wire	Normal					
BRN-other one (350 Ω)	306 Ω ~ 382 Ω					

11-6. TROUBLESHOOTING FLOW

A Check of indoor fan motor

The indoor fan motor error has occurred, and the indoor fan does not operate.

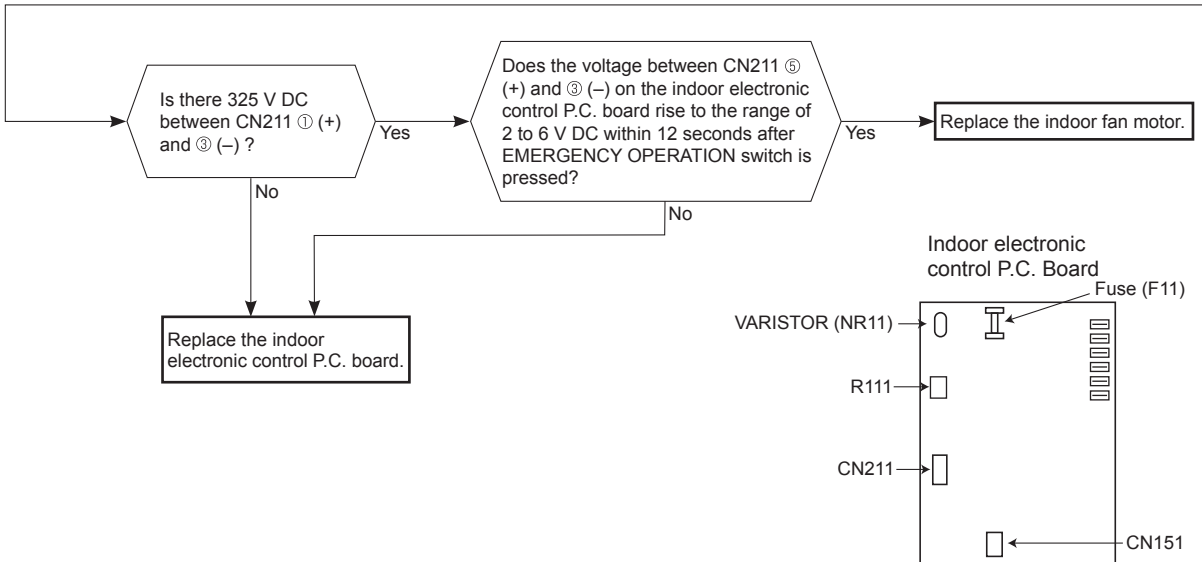
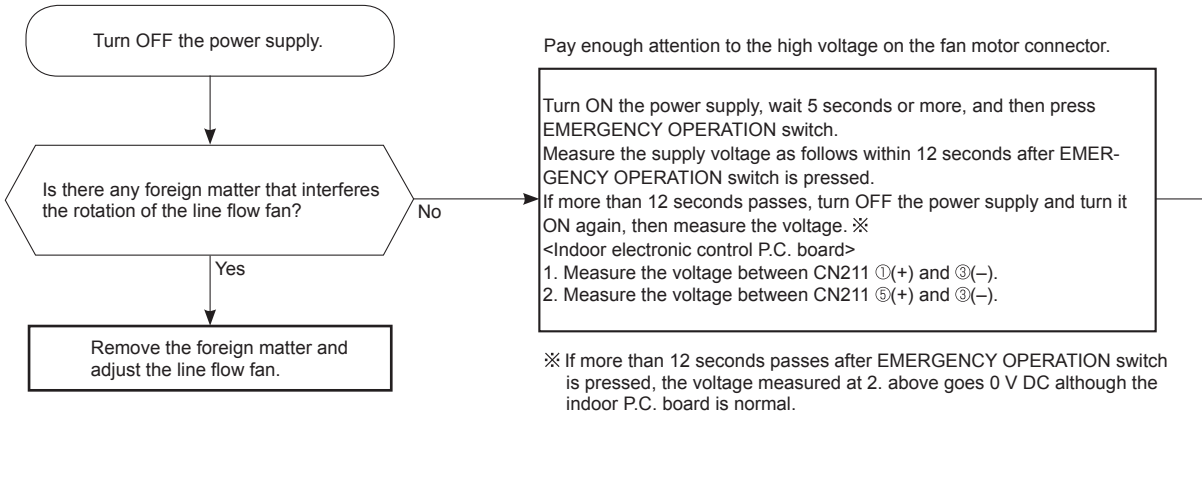

The indoor fan motor error has occurred, and the indoor fan repeats "12-second ON and 30-second OFF" 3 times, and then stops.

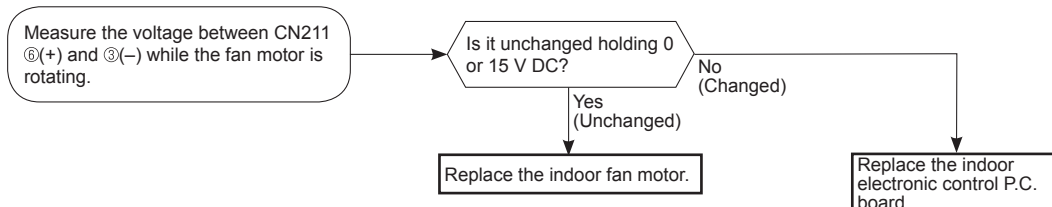

B Check of remote controller, display receiver P.C. board and indoor control P.C. board

※Check if the remote controller is exclusive for this air conditioner.

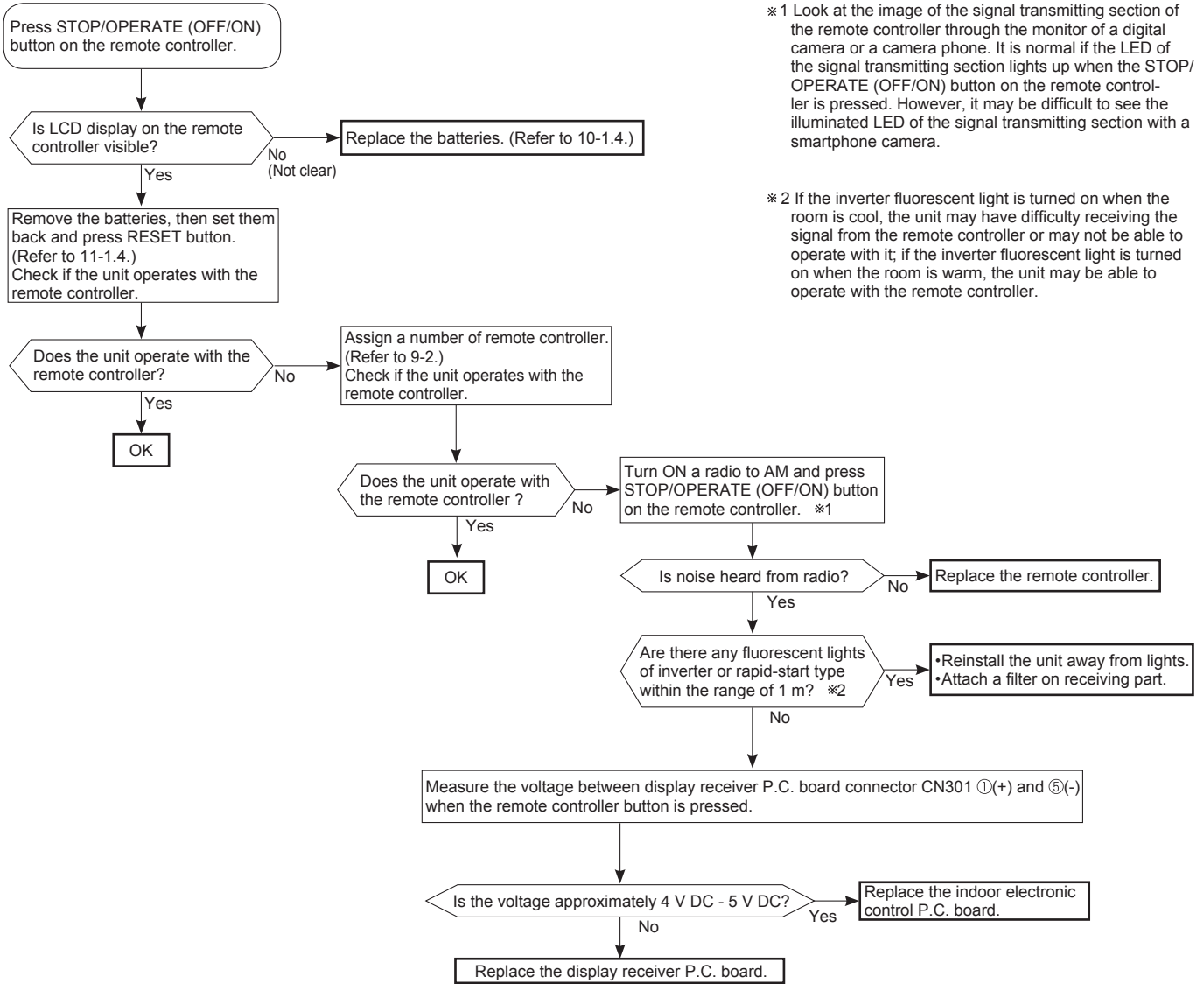

※1 Look at the image of the signal transmitting section of the remote controller through the monitor of a digital camera or a camera phone. It is normal if the LED of the signal transmitting section lights up when the STOP/OPERATE (OFF/ON) button on the remote controller is pressed. However, it may be difficult to see the illuminated LED of the signal transmitting section with a smartphone camera.

※2 If the inverter fluorescent light is turned on when the room is cool, the unit may have difficulty receiving the signal from the remote controller or may not be able to operate with it; if the inverter fluorescent light is turned on when the room is warm, the unit may be able to operate with the remote controller.

© Check of indoor electronic control P.C. board and indoor fan motor

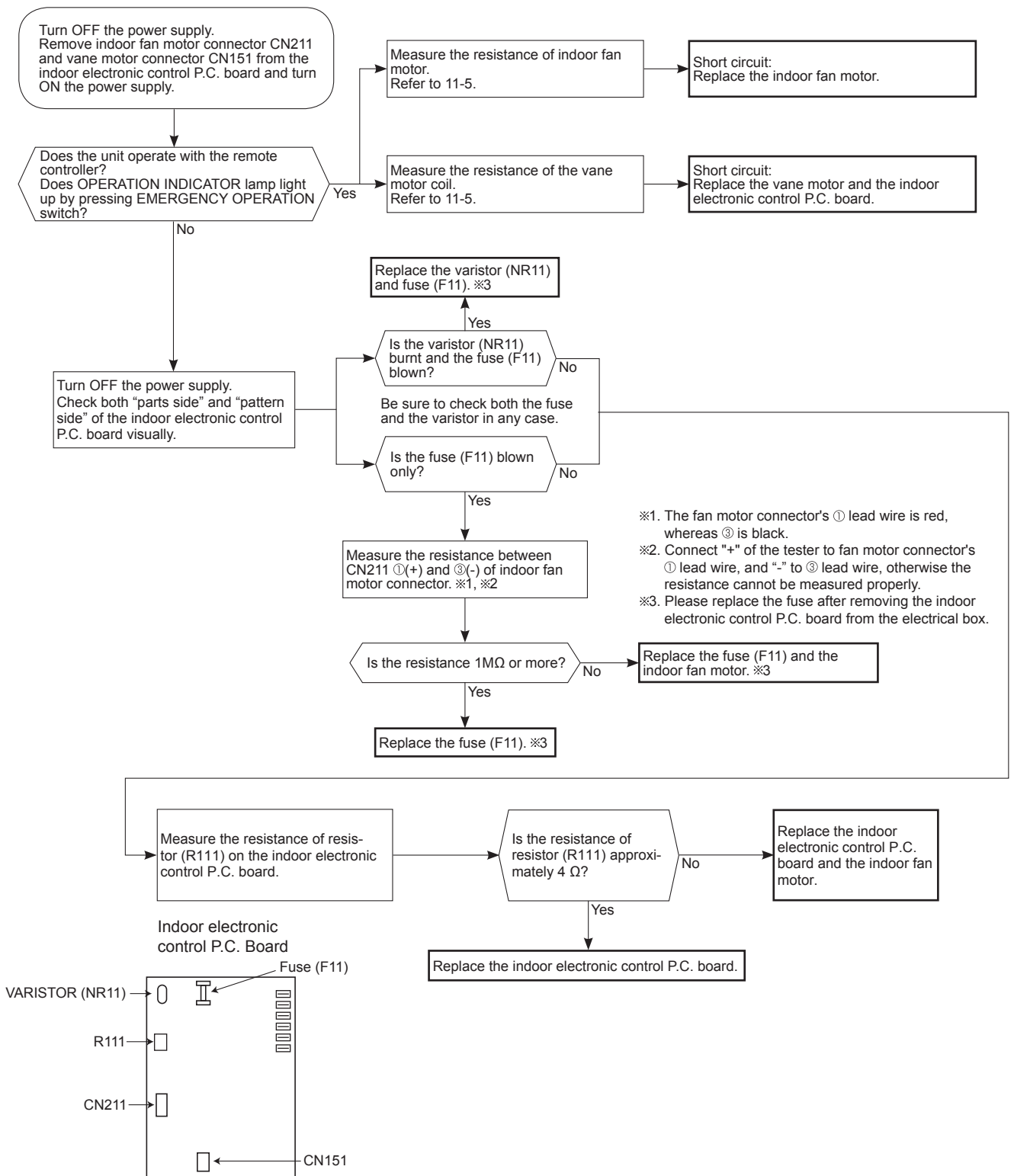

D How to check miswiring and serial signal error

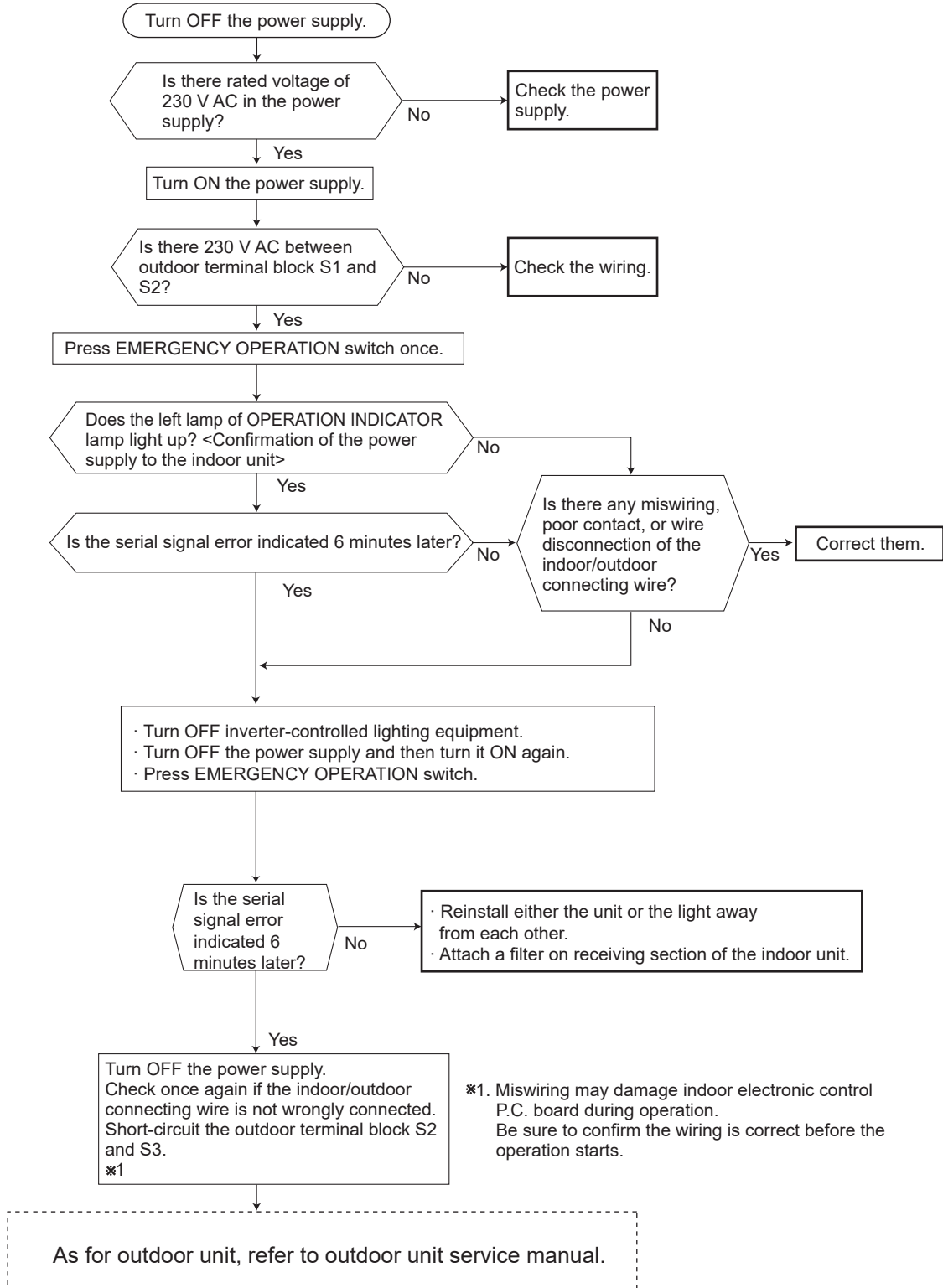

E Electromagnetic noise enters into TV sets or radios

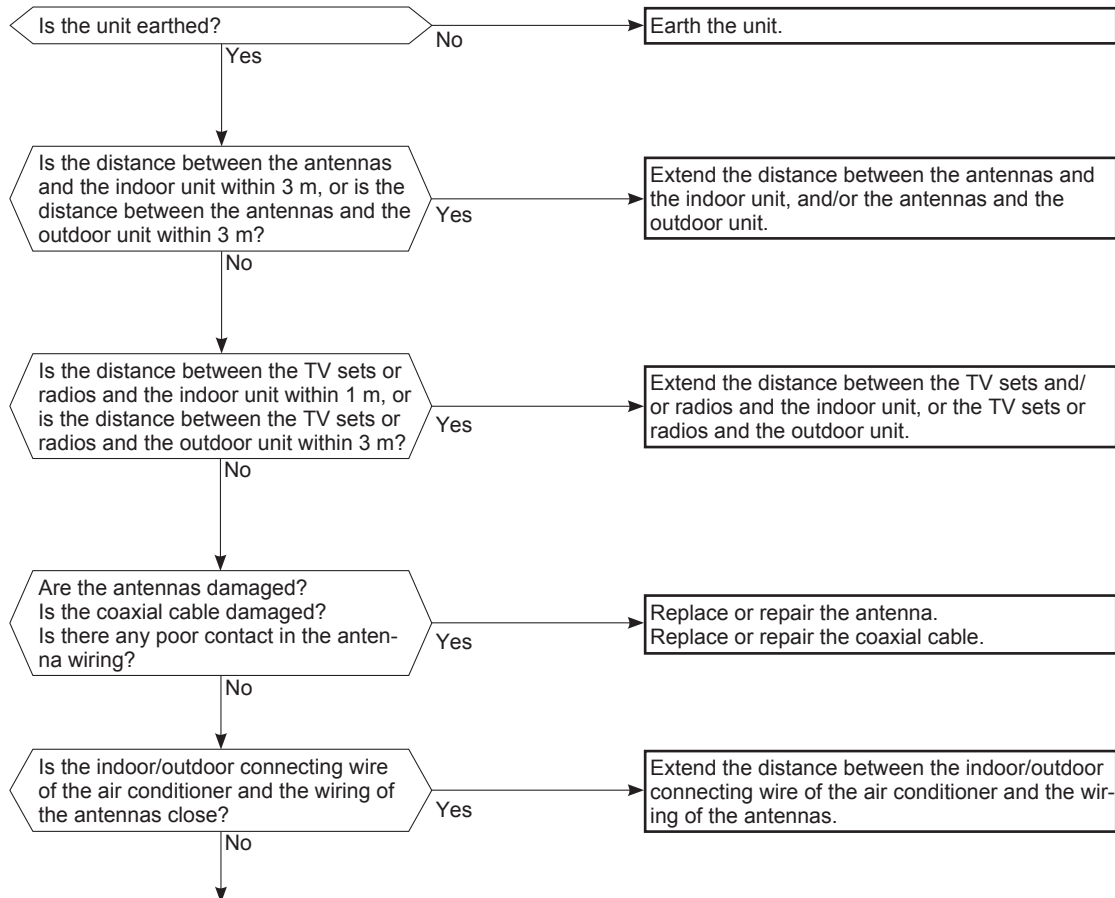

Even if all of the above conditions are fulfilled, the electromagnetic noise may enter, depending on the electric field strength or the installation condition (combination of specific conditions such as antennas or wiring).

Check the following before asking for service.

1. Devices affected by the electromagnetic noise
TV sets, radios (FM/AM broadcast, shortwave)
2. Channel, frequency, broadcast station affected by the electromagnetic noise
3. Channel, frequency, broadcast station unaffected by the electromagnetic noise
4. Layout of:
indoor/outdoor unit of the air conditioner, indoor/outdoor wiring, earth wire, antennas, wiring from antennas, receiver
5. Electric field intensity of the broadcast station affected by the electromagnetic noise
6. Presence or absence of amplifier such as booster
7. Operation condition of air conditioner when the electromagnetic noise enters in
 - 1) Turn OFF the power supply once, and then turn ON the power supply. In this situation, check for the electromagnetic noise.
 - 2) Within 3 minutes after turning ON the power supply, press STOP/OPERATE (OFF/ON) button on the remote controller for power ON, and check for the electromagnetic noise.
 - 3) After a short time (3 minutes later after turning ON), the outdoor unit starts running. During operation, check for the electromagnetic noise.
 - 4) Press STOP/OPERATE (OFF/ON) button on the remote controller for power OFF, when the outdoor unit stops but the indoor/outdoor communication still runs on. In this situation, check for the electromagnetic noise.

11-7. TEST POINT DIAGRAM AND VOLTAGE
MFZ-KT25VG MFZ-KT35VG MFZ-KT50VG MFZ-KT60VG
Indoor electronic control P.C. board

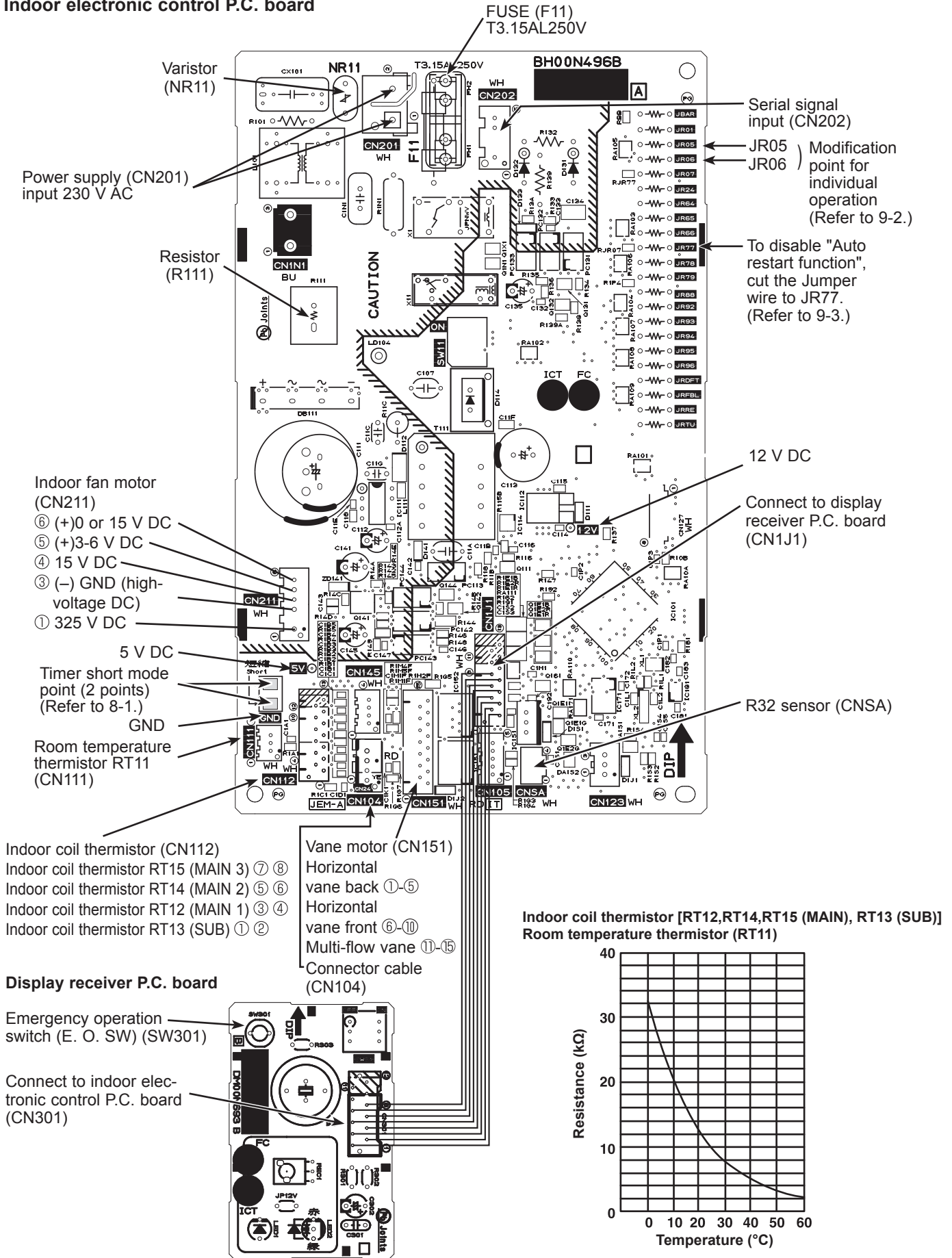

<Detaching method of the terminal with locking mechanism>

The terminal which has the locking mechanism can be detached as shown below.

There are following 2 types of the terminal with locking mechanism.

The terminal without locking mechanism can be detached by pulling it out.

Check the shape of the terminal before detaching.

(1) Slide the sleeve and check if there is a locking lever or not.

(2) The terminal with the connector shown below locking mechanism.

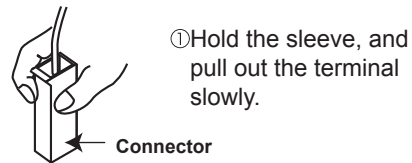
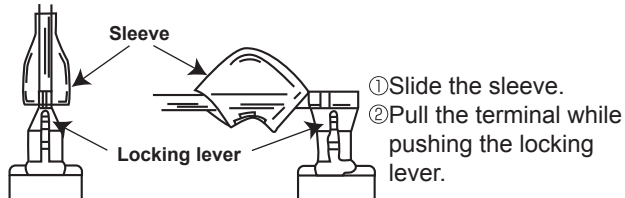

→ : Indicates the visible parts in the photos/figures.
--- : Indicates the invisible parts in the photos/figures.

12-1. MFZ-KT25VG MFZ-KT35VG MFZ-KT50VG MFZ-KT60VG

NOTE: Turn OFF the power supply before disassembly.

OPERATING PROCEDURE	PHOTOS/FIGURES
<p>1. Removing the panel</p> <ol style="list-style-type: none"> (1) Push down the tabs on the both sides of the unit. (2) Open the front panel toward you and pull it out upwards. (3) Remove the screws of the panel. (4) Open the horizontal vane (back) and push the ▼ marks on the top of the panel, and pull the panel toward you. (5) Lift up the panel and remove it from the unit. 	<p>Photo 1</p> <p>Tabs of the unit</p> <p>Photo 2</p> <p>Push the ▼ marks.</p>
<p>2. Removing the electrical box</p> <ol style="list-style-type: none"> (1) Remove the panel. (Refer to section 1.) (2) Remove the screw of the V.A. clamp cover and remove the V.A. clamp cover. (3) Remove the screw of the electrical cover and remove the electrical cover. (4) Remove the earth wire connected to the indoor heat exchanger. (Photo 4) (5) Remove the screw of the electrical box. (Photo 5) (6) Disconnect the following connectors on the electronic control P.C. board. <ul style="list-style-type: none"> • Fan motor connector < CN211 > (Photo 5) • Indoor coil thermistor connector < CN112 > (Photo 5) (7) Rotate the display receiver P.C. board holder to the right side and disconnect the vane motor relay connector. (Photo 6) (8) Disengage the electrical box from the upper catch and pull out the electrical box from the box. 	<p>Screw of the panel</p> <p>Screw of the panel</p> <p>Photo 3</p> <p>Screw of the electrical cover</p> <p>Screw of the V.A. clamp cover</p>

OPERATING PROCEDURE

3. Removing the electronic control P.C. board and the display receiver P.C. board

- (1) Remove the panel. (Refer to section 1.)
- (2) Remove the electrical box. (Refer to section 2.)
- (3) Remove the earth wire connected to the electronic control P.C. board.
- (4) Disconnect all the connectors on the electronic control P.C. board.
- (5) Pull out the electronic control P.C. board from the electrical box.
- (6) Disengage the catches on the lead guide.
- (7) Disengage the display receiver P.C. board holder from the catch on the electrical box.
- (8) Open the display receiver P.C. board holder and pull out the display receiver P.C. board.

※ Attaching the connectors

Run the lead wires with the connectors as they were before the disassembly.

4. Removing the nozzle assembly

- (1) Remove the panel. (Refer to section 1.)
- (2) Rotate the display receiver P.C. board holder to the right side and disconnect the vane motor relay connector.
- (3) Remove the fixed screws on the both sides of the nozzle.
- (4) Disengage the catches on the nozzle from the box.
- (5) Hold the both sides of the nozzle. Rotate the nozzle toward you around the right and left ribs to remove it.

Photo 7

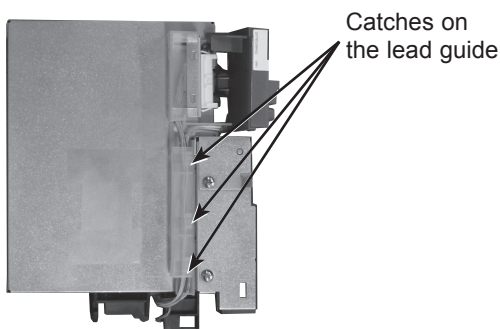
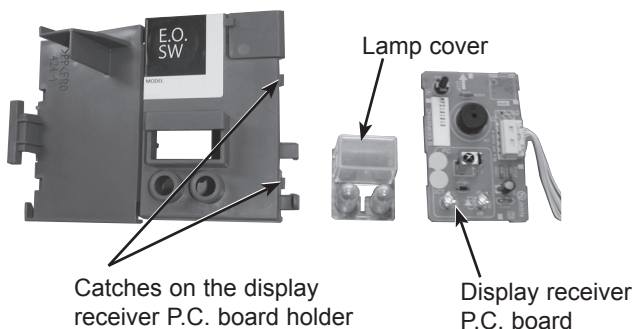

Photo 8



PHOTOS/FIGURES

Photo 4

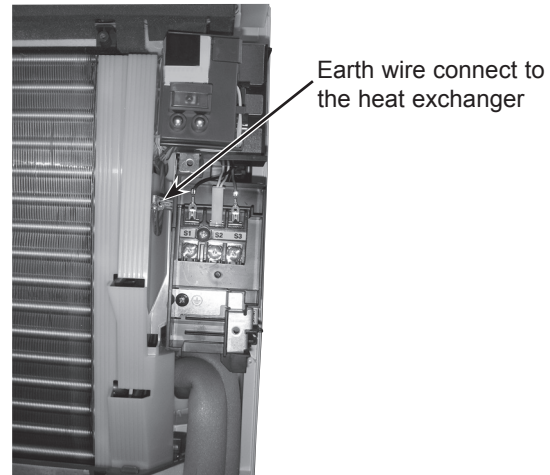

Photo 5

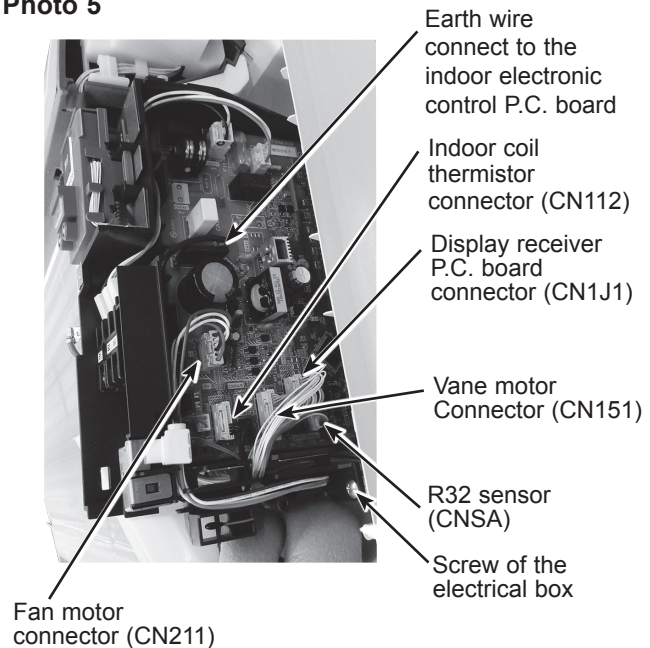
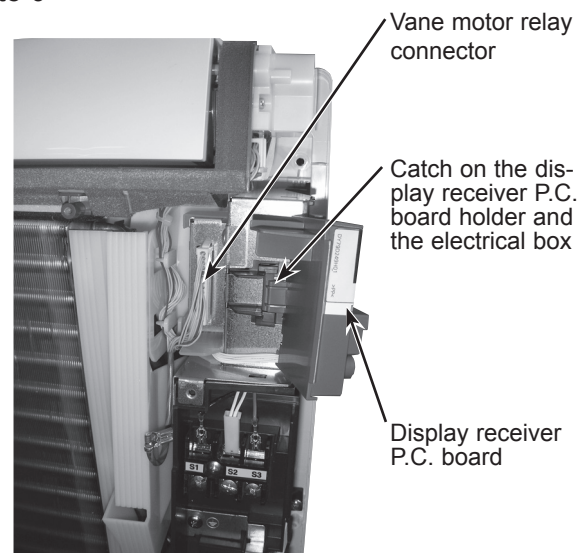
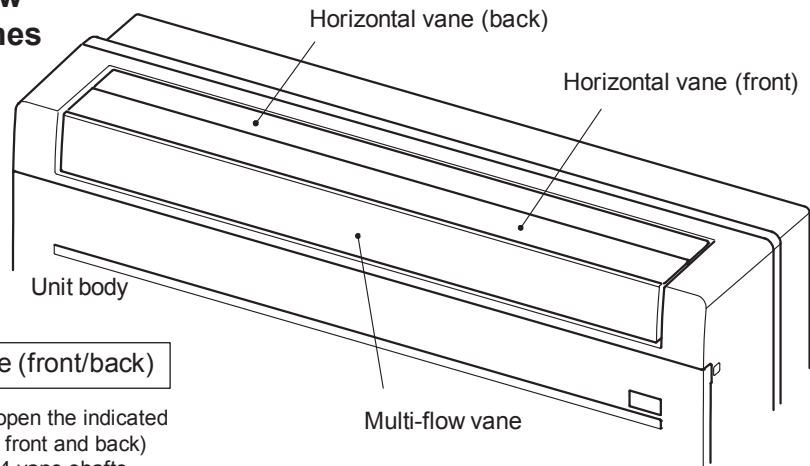

Photo 6



How to remove the multi-flow vane and the horizontal vanes



(1) Removing the horizontal vane (front/back)

(1)-1. See the figure below and push to open the indicated places on the horizontal vanes (between front and back) with your fingers so that you can access 4 vane shafts positioned on the back of the horizontal vanes. (vane shafts on each horizontal vane)

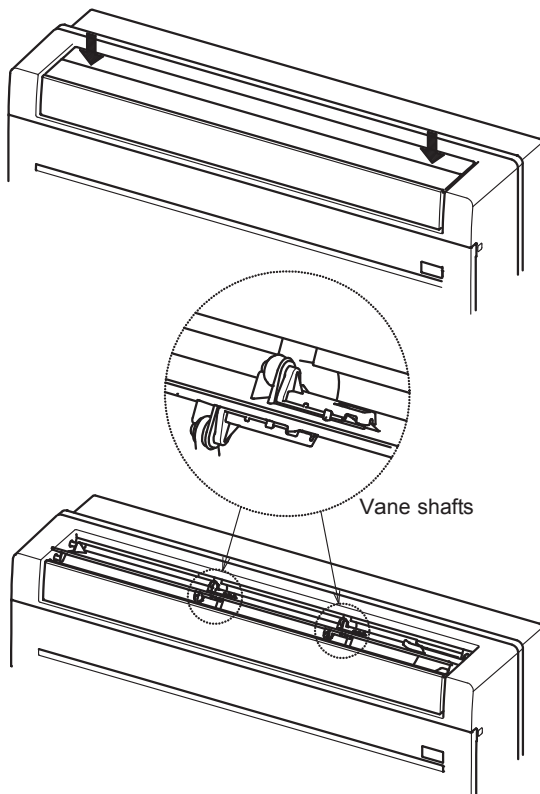

(1)-2. Insert a tool such as a precision screwdriver in the opening on the vane shaft and lift the catch of the vane shaft in arrow 1 direction to detach it from the rib on the multi-flow vane. Slide the vane shaft in arrow 2 direction and separate it from the unit body.

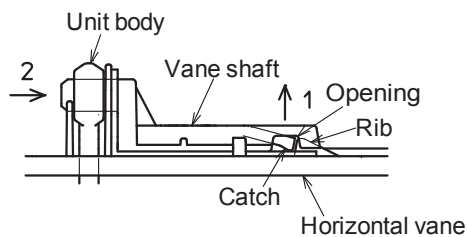

(1)-3. Remove the axial rods on the both ends of the horizontal vane from the unit body.

(2) Removing the multi-flow vane

(2)-1. Open the horizontal vanes (front and back) by following (1)-1. Make sure that 3 vane shafts are on the back of the multi-flow vane.

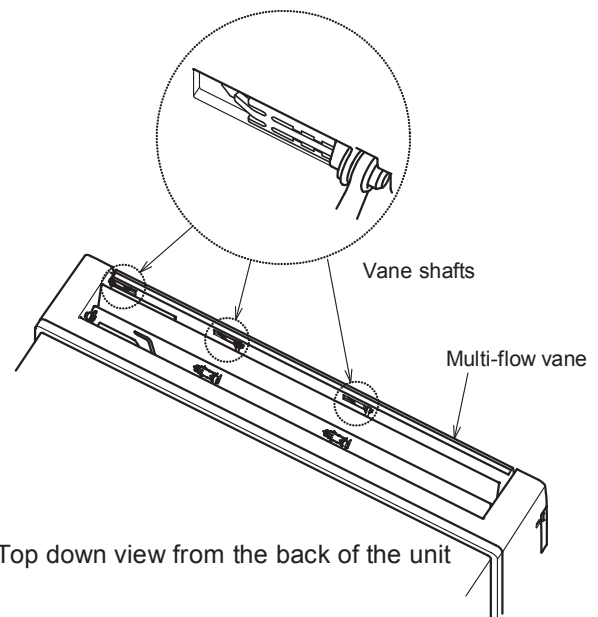

(2)-2. Insert a tool such as a precision screwdriver in the gap between multi-flow vane and the vane shaft and lift the catch of the vane shaft in the arrow 1 direction to detach it from the rib on the multi-flow vane. Slide the vane shaft in arrow 2 direction and separate it from the unit body.

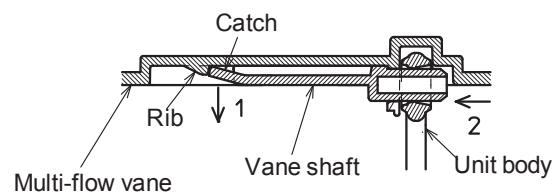

(2)-3. Remove the axial rod on the one end of the multi-flow vane from the unit body.

OPERATING PROCEDURE

5. Removing the horizontal vane motor

- (1) Remove the panel. (Refer to section 1.)
- (2) Remove the screws of the horizontal vane motor support and pull out the horizontal vane motor support from the nozzle.
- (3) Remove the screws of the horizontal vane motors.
- (4) Remove the horizontal vane motors from the horizontal vane motor support.
- (5) Disconnect the connectors from the horizontal vane motor.

※ Installing the horizontal vane motor

Connect the connectors to the horizontal vane motors by referring to the colors, red and white, noted on the vane motor support.

6. Removing the multi-flow vane motor unit

- (1) Remove the panel. (Refer to section 1.)
- (2) Disconnect the connector from the multi-flow vane motor unit.
- (3) Remove the screws of the multi-flow vane motor unit and pull out the multi-flow vane motor unit from the nozzle.

PHOTOS/FIGURES

Photo 9

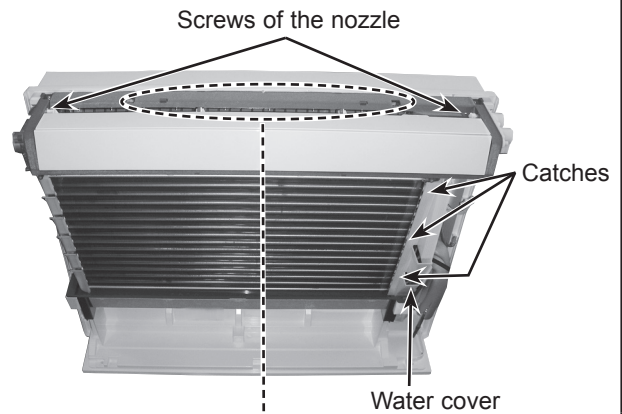

Photo 10

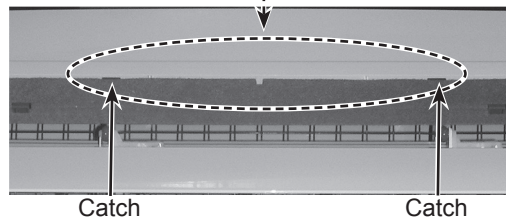

Photo 11

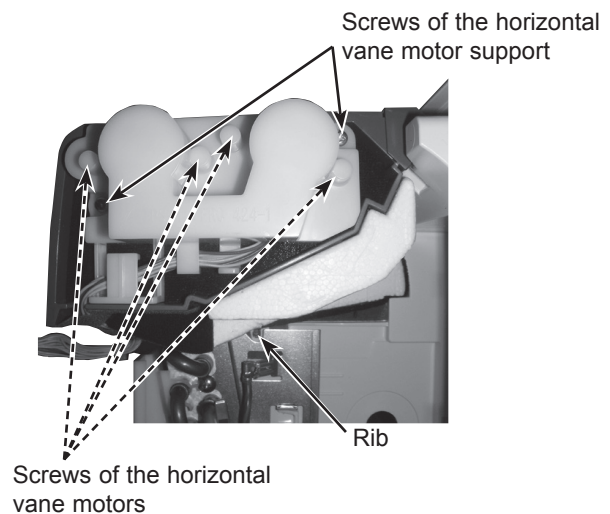
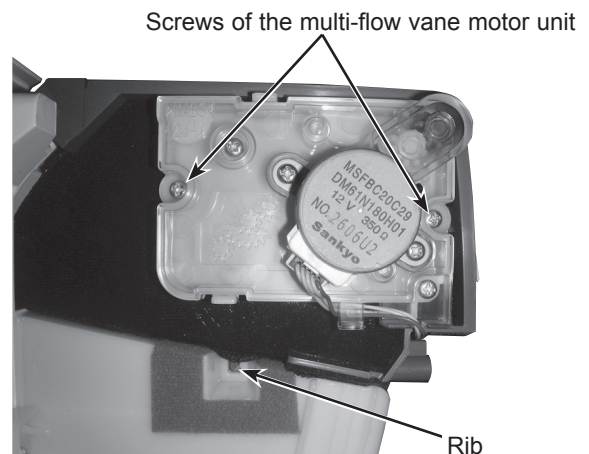

Photo 12



OPERATING PROCEDURE

7. Removing the line flow fan and the indoor fan motor

- (1) Remove the panel. (Refer to section 1.)
- (2) Remove the electrical box. (Refer to section 2.)
- (3) Remove the nozzle. (Refer to section 4.)
- (4) Disengage the water cover from the catches. (Photo 9)
- (5) Remove the screws fixing the motor bed.
- (6) Loosen the screw fixing the line flow fan.
- (7) Remove the motor bed together with the indoor fan motor and the motor band.
- (8) Disengage the catches on the motor band and remove the motor band, and pull out the indoor fan motor.
- (9) Remove the screws fixing the both sides of the heat exchanger.
- (10) Disengage the catch on the right side on the heat exchanger.
- (11) Lift the heat exchanger, and pull out the line flow fan upward.

Photo 16

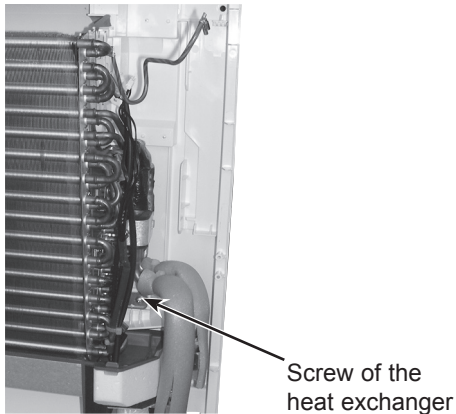

Photo 17



PHOTOS/FIGURES

Photo 13

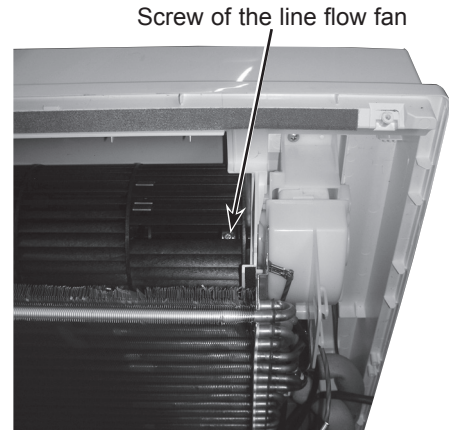

Photo 14

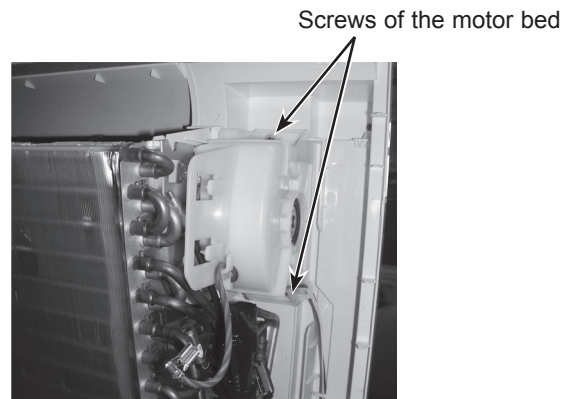
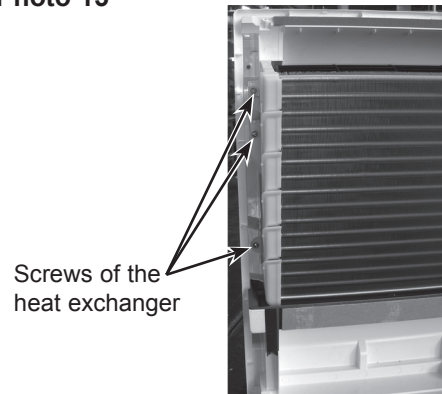

Photo 15



OPERATING PROCEDURE

8. Removing the R32 sensor

- (1) Remove the panel. (Refer to section 1.)
- (2) Loosen the screw of the R32 sensor plate, and take the R32 sensor plate.
- (3) Cut the band fixing the lead wire.
- (4) Disengage the R32 sensor cover from the R32 sensor plate.
- (5) Disengage the catches to open the R32 sensor cover.
- (6) Take the R32 sensor, then disconnect the lead wire.

PHOTOS/FIGURES

Photo 18

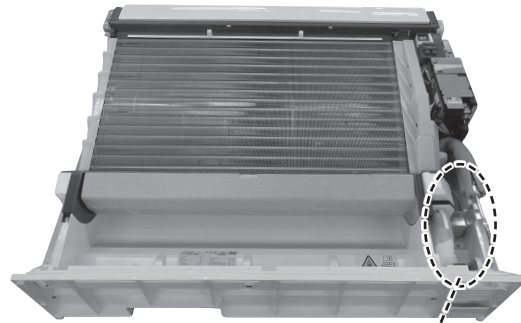

Photo 20

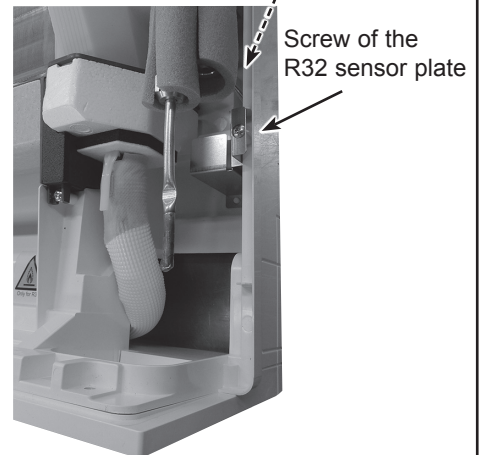
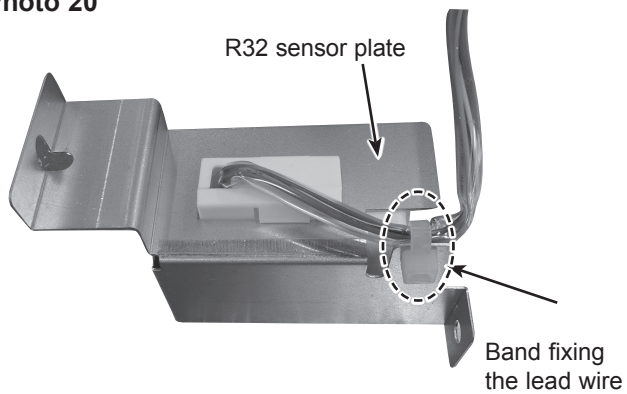

Photo 19

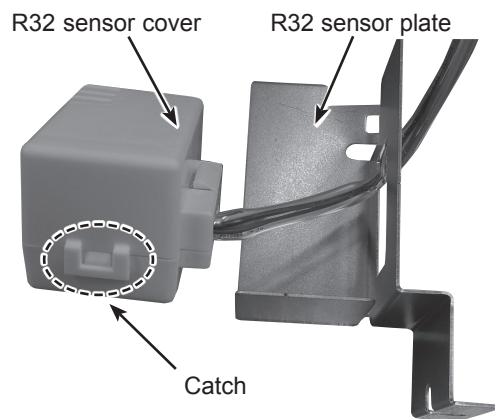
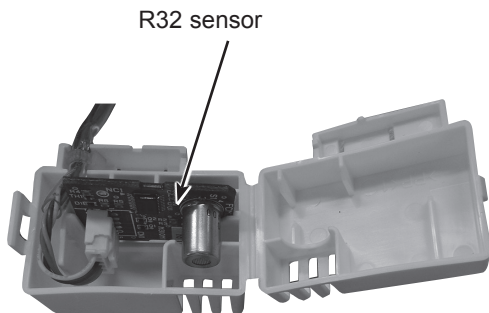

Photo 21



MITSUBISHI ELECTRIC CORPORATION

HEAD OFFICE: TOKYO BUILDING, 2-7-3, MARUNOUCHI, CHIYODA-KU, TOKYO 100-8310, JAPAN

© Copyright 2019 MITSUBISHI ELECTRIC CORPORATION

Issued: Aug. 2019. No. OBH843 REVISED EDITION-A

Published: Jun. 2019. No. OBH843

Made in Japan

Specifications are subject to change without notice.