

INDOOR UNIT

No. OBH844

SERVICE MANUAL

Models

MSZ-HR25VF - E6

MSZ-HR35VF - E6

MSZ-HR42VF - E6

MSZ-HR50VF - E6

Outdoor unit service manual
MUZ-HR-VF Series (OBH823)
MXZ-HA-VF Series (OBH828)



CONTENTS

1. TECHNICAL CHANGES	2
2. PART NAMES AND FUNCTIONS.....	3
3. SPECIFICATION.....	4
4. NOISE CRITERIA CURVES	5
5. OUTLINES AND DIMENSIONS	6
6. WIRING DIAGRAM.....	7
7. REFRIGERANT SYSTEM DIAGRAM	8
8. SERVICE FUNCTIONS	10
9. MICROPROCESSOR CONTROL	12
10. TROUBLESHOOTING.....	16
11. DISASSEMBLY INSTRUCTIONS.....	29

PARTS CATALOG (OBB844)

Use the specified refrigerant only

Never use any refrigerant other than that specified.

Doing so may cause a burst, an explosion, or fire when the unit is being used, serviced, or disposed of.

Correct refrigerant is specified in the manuals and on the spec labels provided with our products.

We will not be held responsible for mechanical failure, system malfunction, unit breakdown or accidents caused by failure to follow the instructions.

<Preparation before the repair service>

- Prepare the proper tools.
- Prepare the proper protectors.
- Provide adequate ventilation.
- After stopping the operation of the air conditioner, turn off the power-supply breaker and remove the power plug.
- Discharge the capacitor before the work involving the electric parts.

<Precautions during the repair service>

- Do not perform the work involving the electric parts with wet hands.
- Do not pour water into the electric parts.
- Do not touch the refrigerant.
- Do not touch the hot or cold areas in the refrigeration cycle.
- When the repair or the inspection of the circuit needs to be done without turning off the power, exercise great caution not to touch the live parts.

1

TECHNICAL CHANGES

MSZ-HR25VF -^{E6}

MSZ-HR35VF -^{E6}

MSZ-HR42VF -^{E6}

MSZ-HR50VF -^{E6}

1. New model

2

PART NAMES AND FUNCTIONS

MSZ-HR25VF MSZ-HR35VF MSZ-HR42VF MSZ-HR50VF

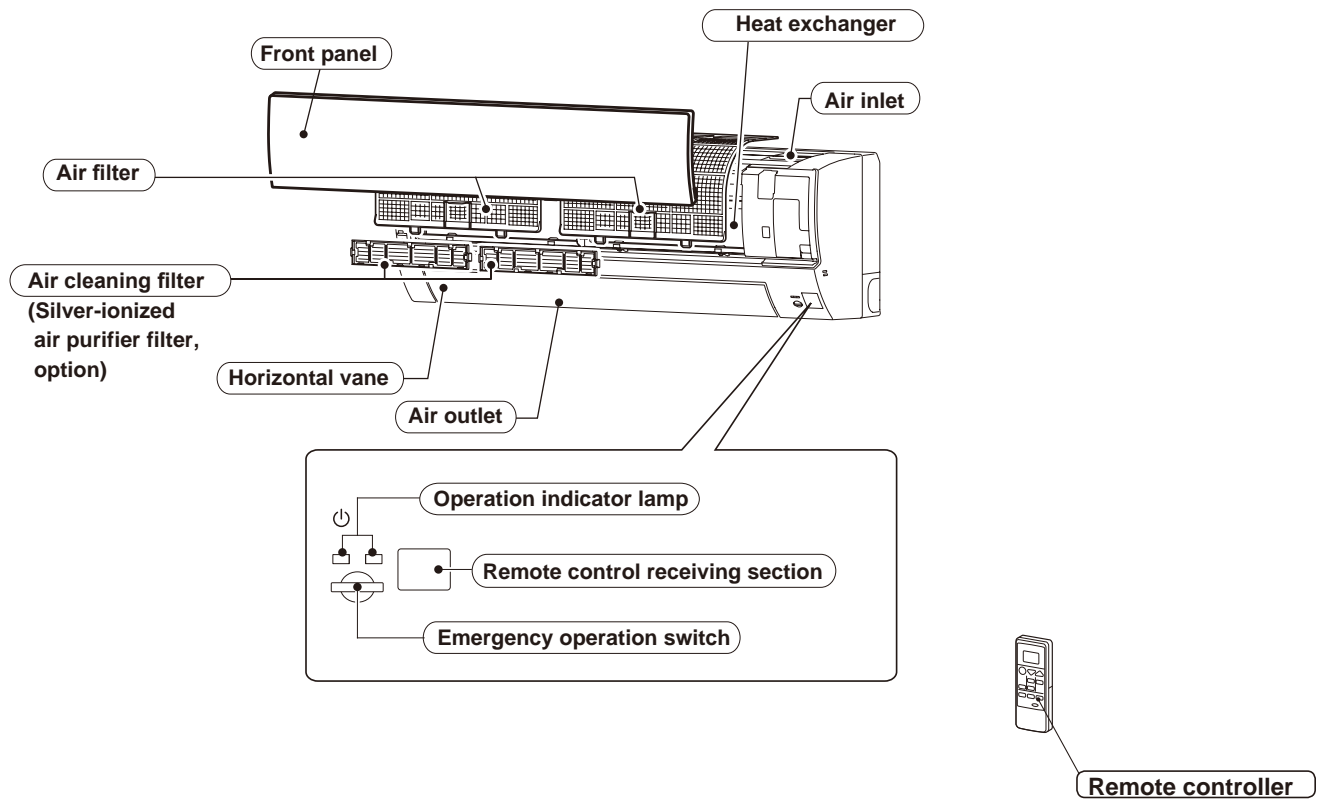

ACCESSORIES

Model	MSZ-HR25VF MSZ-HR35VF MSZ-HR42VF MSZ-HR50VF
① Installation plate	1
② Installation plate fixing screw 4 × 25 mm	5
③ Wireless remote controller	1
④ Felt tape (For left or left-rear piping)	1
⑤ Battery (AAA) for remote controller	2

3

SPECIFICATION

Indoor model				MSZ-HR25VF	MSZ-HR35VF	MSZ-HR42VF	MSZ-HR50VF	
Power supply				Single phase 230 V, 50 Hz				
Electrical data	Power input *1	Cooling	W	20	28	32	39	
		Heating		20	28	32	39	
	Running current *1	Cooling	A	0.20	0.27	0.30	0.36	
		Heating		0.20	0.27	0.30	0.36	
Fan motor	Model			RC0J30-CV				
	Current *1	Cooling	A	0.20	0.27	0.30	0.36	
		Heating		0.20	0.27	0.30	0.36	
Dimensions W × H × D			mm 838 × 280 × 228					
Weight			kg 8.5		9.0			
Special remarks	Air direction			5				
	Airflow	Cooling	Super High	m ³ /h	582	702	786	
			High		432	468	648	672
			Med.		324	336	522	
			Low		216		360	384
		Heating	Super High		606	630	804	870
			High		444		648	672
			Med.		324		474	498
			Low		198		336	366
	Sound level	Cooling	Super High	dB(A)	43	46	45	
			High		37	38	39	40
			Med.		30	31	34	36
			Low		21	22	24	28
		Heating	Super High		43	44	46	47
			High		37		40	41
			Med.		30		32	34
			Low		21		24	27
	Fan speed	Cooling	Super High	rpm	1,120	1,280	1,130	
			High		900	950	970	1,000
			Med.		730	750	830	860
			Low		550		630	660
		Heating	Super High		1,150	1,180	1,150	1,220
			High		920		970	1,000
			Med.		730		770	800
Low			520		600	640		
Fan speed regulator			4					
Remote controller model			RH18A					

NOTE: Test conditions are based on ISO 5151.

Cooling: Indoor Dry-bulb temperature 27°C Wet-bulb temperature 19°C
Outdoor Dry-bulb temperature 35°C Wet-bulb temperature 24°C

Heating: Indoor Dry-bulb temperature 20°C Wet-bulb temperature -
Outdoor Dry-bulb temperature 7°C Wet-bulb temperature 6°C

*1 Measured under rated operating frequency.

Specifications and rated conditions of main electric parts

Model		
Fuse	(F11)	T3.15AL250V
Horizontal vane motor	(MV)	12 V DC
Varistor	(NR11)	470 V
Terminal block	(TB)	3P

4

NOISE CRITERIA CURVES

MSZ-HR25VF

FUNCTION	SPL(dB(A))	LINE
COOLING	43	●—●
HEATING	43	○—○

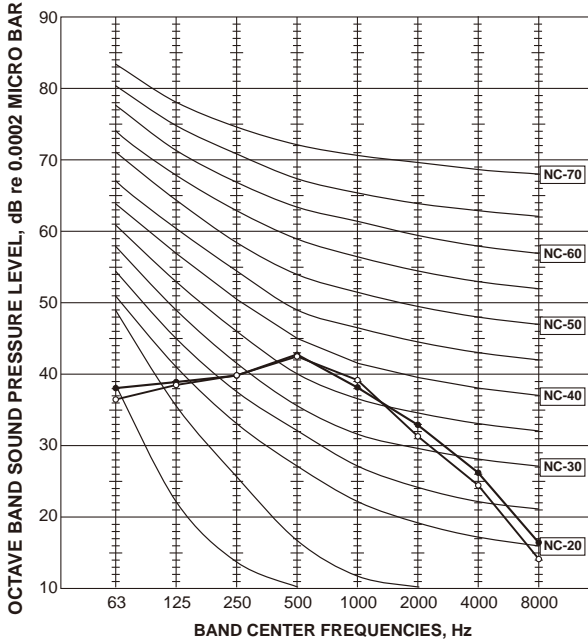

MSZ-HR35VF

FUNCTION	SPL(dB(A))	LINE
COOLING	46	●—●
HEATING	44	○—○

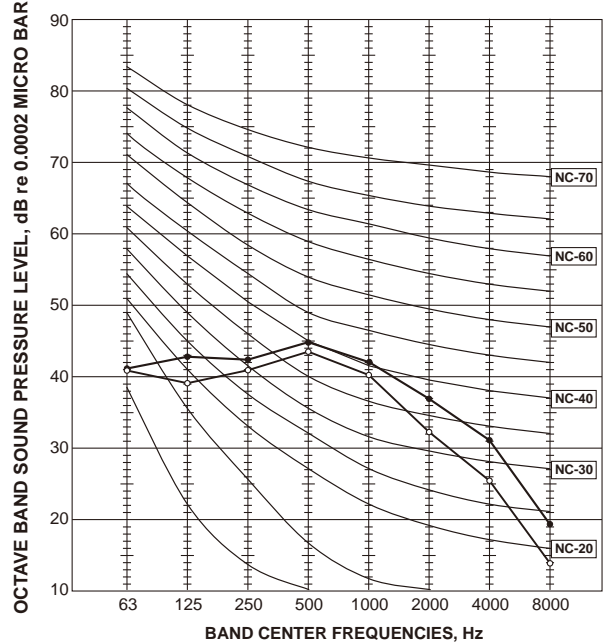

MSZ-HR42VF

FUNCTION	SPL(dB(A))	LINE
COOLING	45	●—●
HEATING	46	○—○

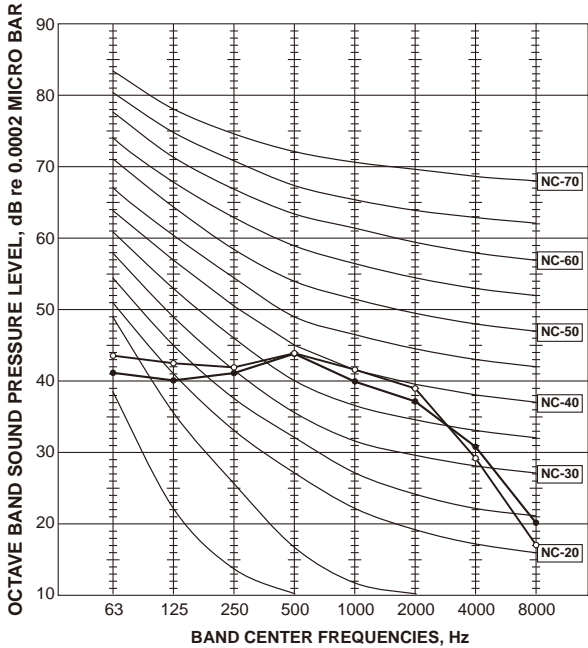

MSZ-HR50VF

FUNCTION	SPL(dB(A))	LINE
COOLING	45	●—●
HEATING	47	○—○

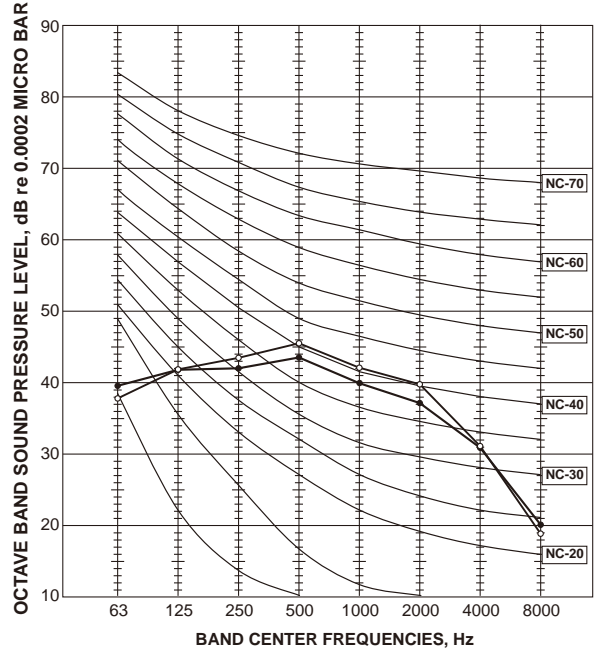

Test conditions

Cooling: Dry-bulb temperature 27°C
 Wet-bulb temperature 19°C
Heating: Dry-bulb temperature 20°C
 Wet-bulb temperature -°C

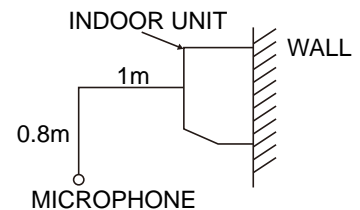

MSZ-HR25VF MSZ-HR35VF MSZ-HR42VF MSZ-HR50VF

Unit: mm

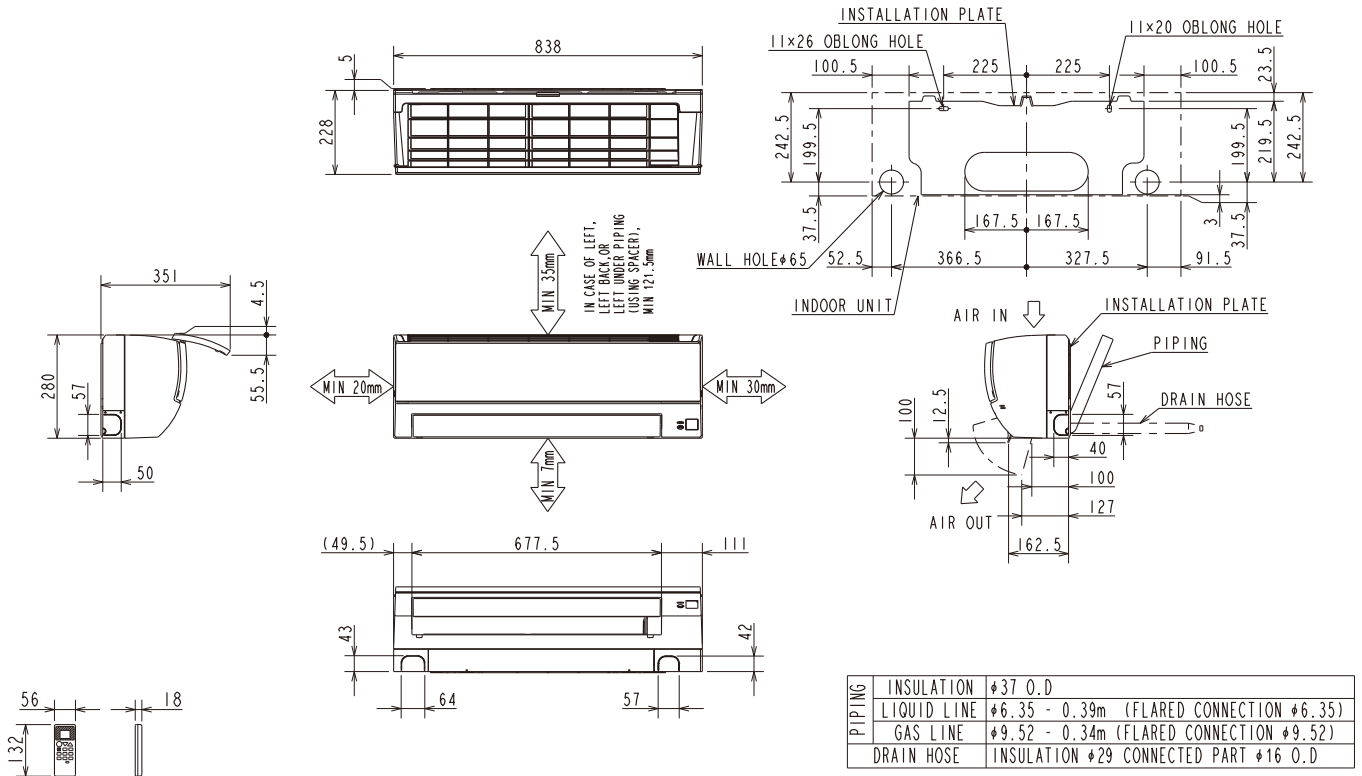

6

WIRING DIAGRAM

MSZ-HR25VF MSZ-HR35VF MSZ-HR42VF MSZ-HR50VF

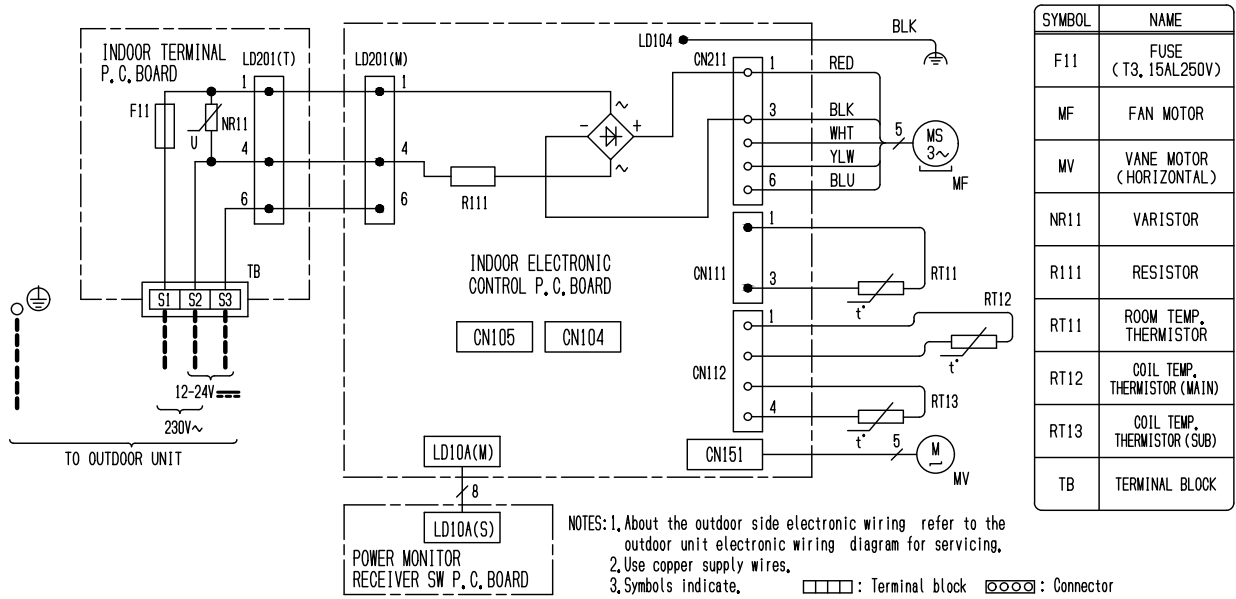

MSZ-HR25VF

Unit: mm

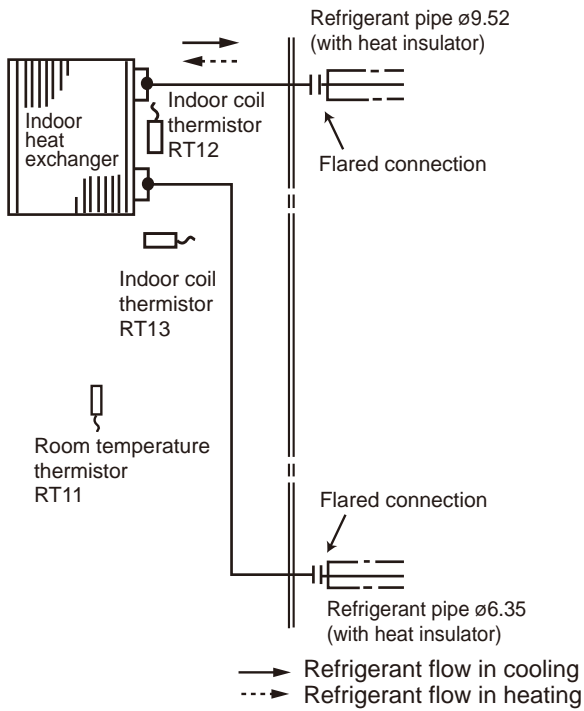

MSZ-HR35VF

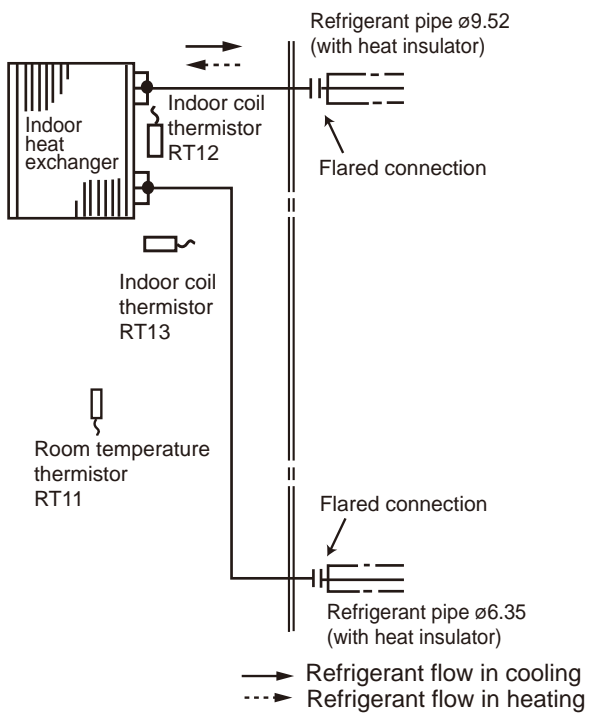

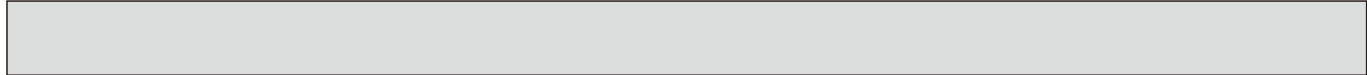

MSZ-HR42VF MSZ-HR50VF

Unit: mm

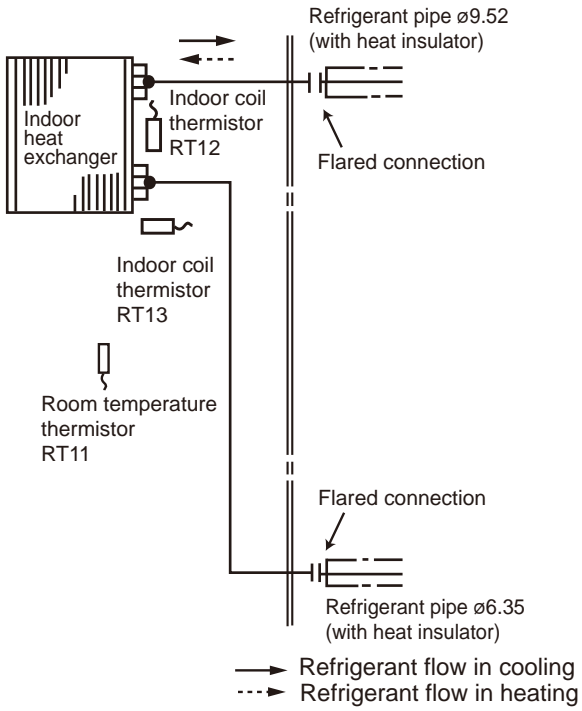

MSZ-HR25VF MSZ-HR35VF MSZ-HR42VF MSZ-HR50VF

8-1. TIMER SHORT MODE

For service, the following set time can be shortened by bridging the timer short mode point on the electronic control P.C. board. (Refer to 10-7.)

- The set time for the ON/OFF timer can be reduced to 1 second for each minute.
- After the breaker is turned on, the time for starting the compressor, which normally takes 3 minutes, can be reduced to 1 minute. Restarting the compressor, which takes 3 minutes, cannot be reduced.

8-2. P.C. BOARD MODIFICATION FOR INDIVIDUAL OPERATION

A maximum of 4 indoor units with wireless remote controllers can be used in a room.

In this case, to operate each indoor unit individually by each remote controller, P.C. boards of remote controller must be modified according to the number of the indoor unit.

How to modify the remote controller P.C. board

Remove batteries before modification.

The board has a print as shown below :

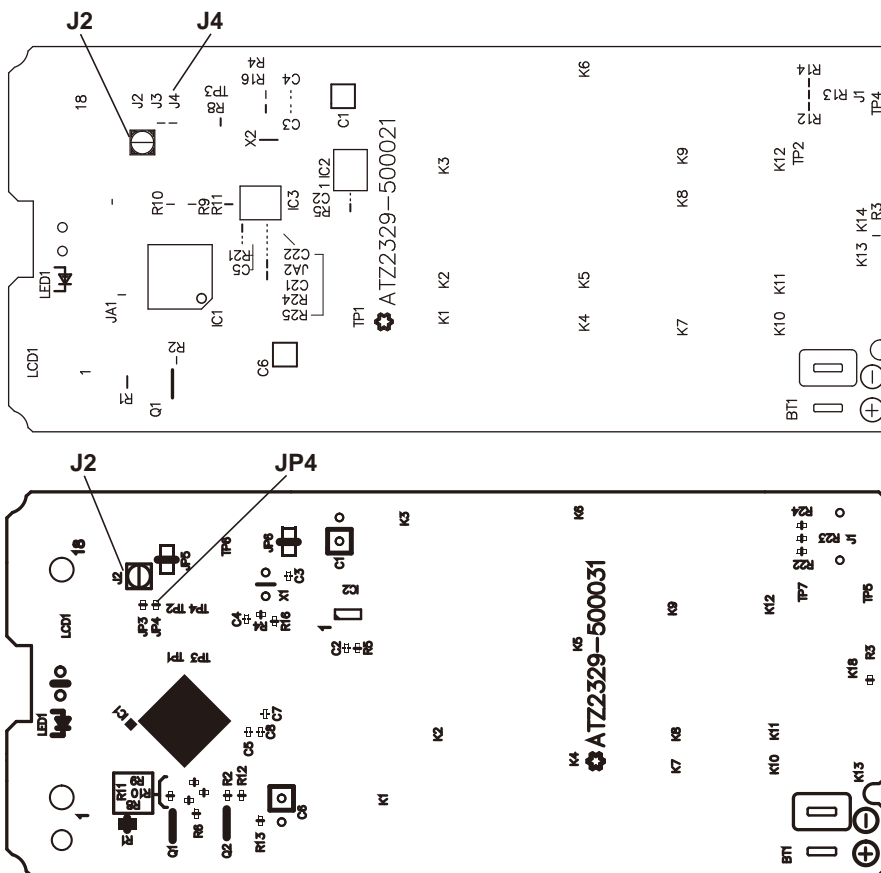

NOTE : For modification, take out the batteries and press the STOP/OPERATE/ (OFF/ ON) button 2 or 3 times at first.

After finish modification, put back the batteries then press the RESET button.

The P.C. board has the print “J2” and “J4/JP4”. Solder “J2” and “J4/JP4” according to the number of indoor unit as shown in Table 1.

After modification, press the RESET button.

Table 1

	1 unit operation	2 units operation	3 units operation	4 units operation
No. 1 unit	No modification	Same as at left	Same as at left	Same as at left
No. 2 unit	—	Solder J2	Same as at left	Same as at left
No. 3 unit	—	—	Solder J4/JP4	Same as at left
No. 4 unit	—	—	—	Solder both J2 and J4/JP4

How to set the remote controller exclusively for particular indoor unit

After you turn the breaker ON, the first remote controller that sends the signal to the indoor unit will be regarded as the remote controller for the indoor unit.

The indoor unit will only accept the signal from the remote controller that has been assigned to the indoor unit once they are set. The setting will be cancelled if the breaker is turned OFF, or the power supply is shut down.

Please conduct the above setting once again after the power has been restored.

8-3. AUTO RESTART FUNCTION

When the indoor unit is controlled with the remote controller, the operation mode, the set temperature, and the fan speed are memorized by the indoor electronic control P.C. board. "AUTO RESTART FUNCTION" automatically starts operation in the same mode just before the shutoff of the main power.

Operation

- ① If the main power has been cut, the operation settings remain.
- ② After the power is restored, the unit restarts automatically according to the memory.
(However, it takes at least 3 minutes for the compressor to start running.)

How to disable "AUTO RESTART FUNCTION"

- ① Turn off the main power for the unit.
- ② Cut the jumper wire to JR77 on the indoor electronic control P.C. board. (Refer to 10-7.)

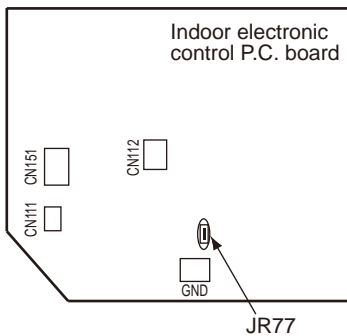

NOTE:

- The operation settings are memorized when 10 seconds have passed after the indoor unit was operated with the remote controller.
- If main power is turned OFF or a power failure occurs while AUTO START/STOP timer is active, the timer setting is cancelled.
- If the unit has been turned OFF with the remote controller before power failure, the auto restart function does not work as the power button of the remote controller is OFF.
- To prevent the breaker from tripping OFF due to the rush of starting current, systematize other home appliance not to turn ON at the same time.
- When some air conditioners are connected to the same supply system, if they are operated before power failure, the starting current of all the compressors may flow simultaneously at restart. Therefore, the special counter-measures are required to prevent the main voltage-drop or the rush of the starting current by adding to the system that allows the units to start one by one.

**MSZ-HR25VF MSZ-HR35VF MSZ-HR42VF MSZ-HR50VF
WIRELESS REMOTE CONTROLLER**

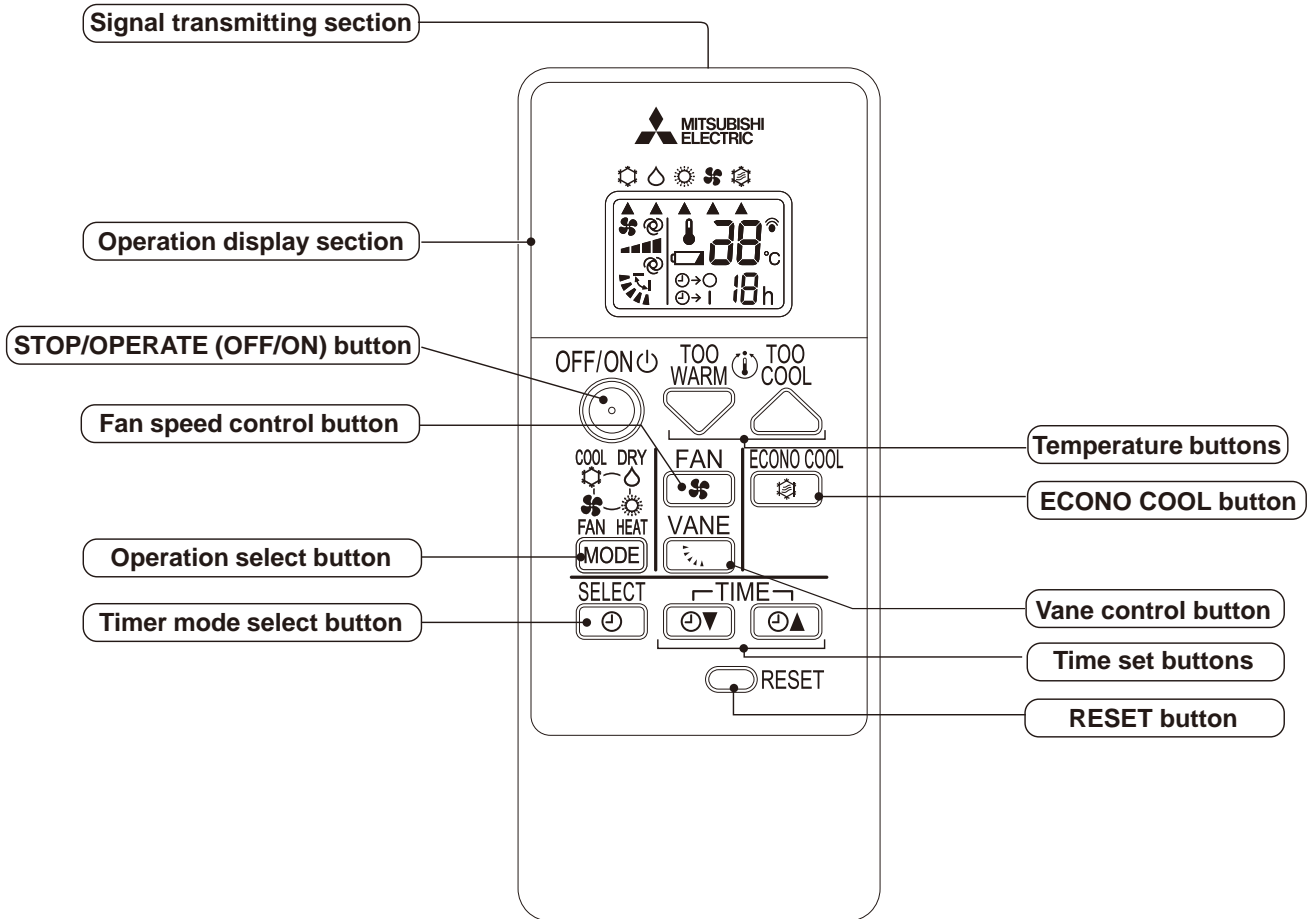

NOTE: Last setting will be stored after the unit is turned OFF with the remote controller. Indoor unit receives the signal of the remote controller with beeps.

INDOOR UNIT DISPLAY SECTION

Operation Indicator lamp

The operation indicator at the right side of the indoor unit indicates the operation state.

•The following indication applies regardless of shape of the indication.

Indication	Operation state	Room temperature
● ●	The unit is operating to reach the set temperature	About 2°C or more away from set temperature
● ○	The room temperature is approaching the set temperature	About 1 to 2°C from set temperature
● ☀	Standby mode (only during multi system operation)	—

● Lit
 ☀ Blinking
 ○ Not lit

9-1. COOL (❄️) OPERATION

- (1) Press STOP/OPERATE (OFF/ON) button.
OPERATION INDICATOR lamp of the indoor unit turns on with a beep tone.
- (2) Select COOL mode with OPERATION SELECT button.
- (3) Press TEMPERATURE buttons (TOO WARM or TOO COOL button) to select the desired temperature. The setting range is 16 - 31°C.

1. Coil frost prevention

The compressor operational frequency is controlled by the temperature of the indoor heat exchanger to prevent the coil from frosting.

When the temperature of indoor heat exchanger becomes too low, the coil frost prevention mode works.

The indoor fan operates at the set speed and the compressor stops. This mode continues until the temperature of indoor heat exchanger rises.

2. Low outside temperature operation

When the outside temperature is lower, low outside temperature operation starts, and the outdoor fan slows or stops.

9-2. DRY (☀️) OPERATION

- (1) Press STOP/OPERATE (OFF/ON) button.
OPERATION INDICATOR lamp of the indoor unit turns on with a beep tone.
- (2) Select DRY mode with OPERATION SELECT button.
- (3) The set temperature is determined from the initial room temperature.

1. Coil frost prevention

Coil frost prevention works the same way as that in COOL mode. (9-1.1.)

2. Low outside temperature operation

Low outside temperature operation works the same way as that in COOL mode. (9-1.2.)

9-3. FAN(🌀) OPERATION

- (1) Press STOP/OPERATE (OFF/ON) button.
OPERATION INDICATOR lamp of the indoor unit turns ON with a beep tone.
- (2) Select FAN mode with OPERATION SELECT button.
- (3) Select the desired fan speed. When AUTO, it becomes Low.
Only indoor fan operates. Outdoor unit does not operate.

9-4. HEAT (🔥) OPERATION

- (1) Press STOP/OPERATE (OFF/ON) button.
OPERATION INDICATOR lamp of the indoor unit turns on with a beep tone.
- (2) Select HEAT mode with OPERATION SELECT button.
- (3) Press TEMPERATURE buttons (TOO WARM or TOO COOL button) to select the desired temperature.
The setting range is 16 ~ 31°C.

1. Cold air prevention control

When the compressor is not operating or is starting, and the temperature of indoor heat exchanger and/or the room temperature is low or when defrosting is being done, the indoor fan will stop or rotate in Very Low speed.

2. High pressure protection

The compressor operational frequency is controlled by the temperature of the indoor heat exchanger to prevent the condensing pressure from increasing excessively.

When the temperature of indoor heat exchanger becomes too high, the high pressure protection works.

The indoor fan operates following the cold air prevention control. This mode continues until the temperature of indoor heat exchanger falls.

3. Defrosting

Defrosting starts when the temperature of outdoor heat exchanger becomes too low.

The compressor stops once, the indoor/outdoor fans stop, the 4-way valve reverses, and the compressor re-starts.

This mode continues until the temperature of outdoor heat exchanger rises or the fixed time passes.

9-5. MULTI SYSTEM OPERATION FOR MULTI SYSTEM AIR CONDITIONER OUTDOOR UNIT: MXZ series

Multi system air conditioner can connect 2 or more indoor units with 1 outdoor unit.

- When trying to operate 2 or more indoor units with 1 outdoor unit simultaneously, one for the cooling and the others for heating, the operation mode of the indoor unit that operates first is selected. Other indoor units cannot operate, and operation indicator lamp blinks as shown in the figure below. In this case, please set all the indoor units to the same operation mode.

OPERATION INDICATOR

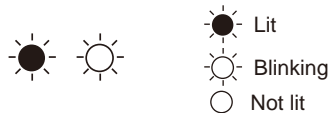

- When indoor unit starts the operation while the defrosting of outdoor unit is being done, it takes a few minutes (max. 10 minutes) to blow out the warm air.
- In the heating operation, though indoor unit is not operating, it may get warm or the sound of refrigerant flow may be heard. It is not malfunction. The reason is that the refrigerant continuously flows into it.

9-6. AUTO VANE OPERATION

1. Horizontal vane

(1) Vane motor drive

These models are equipped with a stepping motor for the horizontal vane. The rotating direction, speed, and angle of the motor are controlled by pulse signals (approximately 12 V) transmitted from indoor microprocessor.

(2) The horizontal vane angle and mode change as follows by pressing VANE CONTROL button.

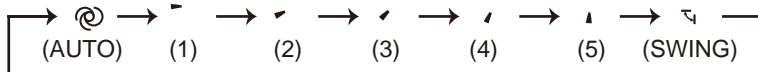

(3) Positioning

To confirm the standard position, the vane moves until it touches the vane stopper. Then the vane is set to the selected angle.

Confirmation of standard position is performed in the following cases:

- When the operation starts or finishes (including timer operation).
- When the test run starts.
- When standby mode (only during multi system operation) starts or finishes.

(4) VANE AUTO (@) mode

In VANE AUTO mode, the microprocessor automatically determines the vane angle to make the optimum room temperature distribution.

In COOL and DRY operation

Vane angle is fixed to Horizontal position.

In HEAT operation

Vane angle is fixed to Angle 4.



(5) STOP (operation OFF) and ON TIMER standby

In the following cases, the horizontal vane returns to the closed position.

- When STOP/OPERATE (OFF/ON) button is pressed (POWER OFF).
- When the operation is stopped by the emergency operation.
- When ON TIMER is ON standby.

(6) Dew prevention

During COOL or DRY operation with the vane angle at Angle 3 to 5 when the compressor cumulative operation time exceeds 1 hour, the vane angle automatically changes to Angle 2 for dew prevention.

(7) SWING () mode

By selecting SWING mode with VANE CONTROL button, the horizontal vane swings vertically.

(8) ECONO COOL () operation (ECONOMical operation)



When ECONO COOL button is pressed in COOL mode, set temperature and the air flow direction is automatically changed by the microprocessor. However, the temperature on the LCD screen on the remote controller is not changed. Also the horizontal vane swings in various cycle.

SWING operation makes you feel cooler than set temperature. So, even though the set temperature is higher, the air conditioner can keep comfort. As a result, energy can be saved.

To cancel this operation, select a different mode or press one of the following buttons in ECONO COOL operation: ECONO COOL, VANE CONTROL button.

9-7. TIMER OPERATION (ON/OFF TIMER)

1. How to set the timer

- (1) Press STOP/OPERATE/ (OFF/ON) button to start the air conditioner.
- (2) Select the timer mode by pressing the  button during operation.
Each time this button is pressed, the timer mode is changed in sequence:
☉→○ (OFF TIMER) → ☉→| (ON TIMER) → TIMER RELEASE
- (3) Set the time of the timer using the  button.
Each time this button is pressed, the set time increase or decrease by 1 hour to 12 hours.

2. To release the timer

Press the  button until ☉→○ (OFF TIMER) and ☉→| (ON TIMER) are not displayed.

NOTE :

- The OFF TIMER and the ON TIMER cannot be set at the same time.
- The displayed time is the time remaining and will decrease in 1-hour increments as time passes.

9-8. EMERGENCY/TEST OPERATION

In the case of test run operation or emergency operation, use EMERGENCY OPERATION switch in the right side of the indoor unit. Emergency operation is available when the remote controller is missing or has failed, or when the batteries in the remote controller are running down. The unit will start and OPERATION INDICATOR lamp will light up.

The first 30 minutes of operation is the test run operation. This operation is for servicing. The indoor fan runs at High speed and the temperature control does not work.

After 30 minutes of test run operation, the system shifts to EMERGENCY COOL/HEAT MODE with a set temperature of 24°C. The fan speed shifts to Med.

The coil frost prevention works even in the test run or the emergency operation.

In the test run or emergency operation, the horizontal vane operates in VANE AUTO (@) mode.

Emergency operation continues until EMERGENCY OPERATION switch is pressed once or twice or the unit receives any signal from the remote controller. In the latter case, normal operation will start.

NOTE: Do not press EMERGENCY OPERATION switch during normal operation.

Operation mode	COOL/HEAT
Set temperature	24°C
Fan speed	Med.
Horizontal vane	Auto

The operation mode is indicated by the Operation Indicator lamp as following Operation Indicator lamp

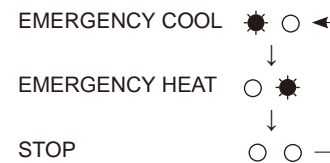

-  Lit
-  Not lit



EMERGENCY OPERATION switch —  E.O.S.W.

9-9. 3-MINUTE TIME DELAY OPERATION

When the system turns OFF, compressor will not restart for 3 minutes as 3-minute time delay function operates to protect compressor from overload.

MSZ-HR25VF MSZ-HR35VF MSZ-HR42VF MSZ-HR50VF

10-1. CAUTIONS ON TROUBLESHOOTING

1. Before troubleshooting, check the following

- 1) Check the power supply voltage.
- 2) Check the indoor/outdoor connecting wire for miswiring.

2. Take care of the following during servicing

- 1) Before servicing the air conditioner, be sure to turn OFF the main unit first with the remote controller, and after confirming the horizontal vane is closed, turn OFF the breaker and/or disconnect the power plug.
- 2) Be sure to turn OFF the power supply before removing the front panel, the cabinet, the top panel, and the P.C. board.
- 3) When removing the P.C. board, hold the edge of the board with care NOT to apply stress on the components.
- 4) When connecting or disconnecting the connectors, hold the connector housing. DO NOT pull the lead wires.

<Incorrect>



Lead wiring

<Correct>



Connector housing

3. Troubleshooting procedure

- 1) Check if the OPERATION INDICATOR lamp on the indoor unit is blinking ON and OFF to indicate an abnormality. To make sure, check how many times the OPERATION INDICATOR lamp is blinking ON and OFF before starting service work.
- 2) Before servicing, check that the connector and terminal are connected properly.
- 3) When the electric control P.C. board seems to be defective, check the copper foil pattern for disconnection and the components for bursting and discoloration.
- 4) When troubleshooting, Refer to 10-2, 10-3 and 10-4.

4. How to replace batteries

Weak batteries may cause the remote controller malfunction.

In this case, replace the batteries to operate the remote controller normally.

- ① Remove the front lid and insert batteries. Then reattach the front lid.

- ② Press RESET button with a thin instrument, and then use the remote controller.

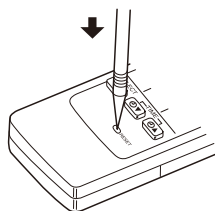
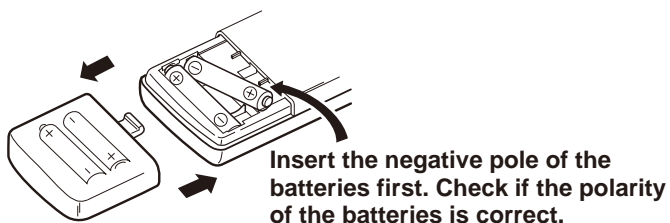

NOTE: 1. If RESET button is not pressed, the remote controller may not operate correctly.

2. This remote controller has a circuit to automatically reset the microcomputer when batteries are replaced.

This function is equipped to prevent the microcomputer from malfunctioning due to the voltage drop caused by the battery replacement.

3. Do not use the leaking batteries.

10-2. FAILURE MODE RECALL FUNCTION

Outline of the function

This air conditioner can memorize the abnormal condition which has occurred once.

Even though LED indication listed on the troubleshooting check table (10-4.) disappears, the memorized failure details can be recalled.

1. Flow chart of failure mode recall function for the indoor/outdoor unit

Operational procedure

The cause of abnormality cannot be found because the abnormality does not recur.

Setting up the failure mode recall function

Turn ON the power supply.
<Preparation of the remote controller>
① While pressing OPERATION SELECT button and TOO COOL button on the remote controller at the same time, press RESET button.
② First, release RESET button.
Hold down the other 2 buttons for another 3 seconds. Make sure that the indicators on the LCD screen shown in the right figure are all displayed. Then release the buttons.

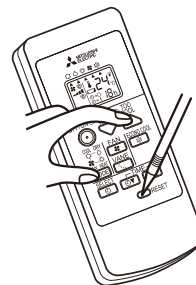

Press STOP/OPERATE (OFF/ON) button of the remote controller (the set temperature is displayed) with the remote controller headed towards the indoor unit. ※1

※1 Regardless of normal or abnormal condition, a short beep is emitted once the signal is received.

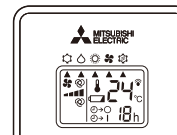

Does left lamp of OPERATION INDICATOR lamp on the indoor unit blink at the interval of 0.5 seconds?

Blinks: Either indoor or outdoor unit is abnormal.
Beep is emitted at the same timing as the blinking of left lamp of OPERATION INDICATOR lamp. ※2

No (OFF)

Indoor unit is normal.
But the outdoor unit might be abnormal because there are some abnormalities that can not be recalled with this way.
Check if outdoor unit is abnormal according to the detailed outdoor unit failure mode recall function.

NOTE: It takes up to 1 minute to indicate the outdoor unit abnormality. Even if the OPERATION INDICATOR lamp is not lighting, keep checking at least 1 minute or longer.

Judgment of indoor/outdoor abnormality

Yes (Blinks)

Before blinking, does left lamp of OPERATION INDICATOR lamp stay ON for 3 seconds?
Stays ON for 3 seconds (without beep):
The outdoor unit is abnormal.

Yes

The outdoor unit is abnormal.
Check the blinking pattern, and identify the abnormal point by referring to the table of outdoor unit failure mode recall function. (Refer to outdoor unit service manual.)
Make sure to check at least 2 consecutive blinking cycles. ※3

The indoor unit is abnormal.
Check the blinking pattern, and identify the abnormal point by referring to the table of indoor unit failure mode recall function. (Refer to 10-2.2)
Make sure to check at least 2 consecutive blinking cycles. ※2

Releasing the failure mode recall function

Release the failure mode recall function by the following procedures.
Turn OFF the power supply and turn it ON again.
Press RESET button of the remote controller.

Repair the failure parts.

Deleting the memorized abnormal condition

① After repairing the unit, recall the failure mode again according to "Setting up the failure mode recall function" mentioned above.
② Press STOP/OPERATE (OFF/ON) button of the remote controller (the set temperature is displayed) with the remote controller headed towards the indoor unit.
③ Press EMERGENCY OPERATION switch so that the memorized abnormal condition is deleted.
④ Release the failure mode recall function according to "Releasing the failure mode recall function" mentioned above.

NOTE: 1. Make sure to release the failure mode recall function after it is set up, otherwise the unit cannot operate properly.

2. If the abnormal condition is not deleted from the memory, the last abnormal condition is kept memorized.

※2. Blinking pattern when the indoor unit is abnormal:

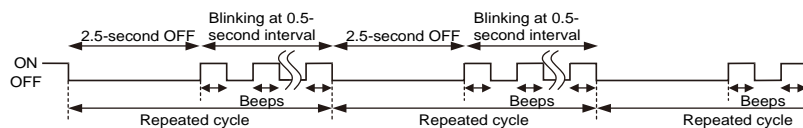

※3. Blinking pattern when the outdoor unit is abnormal:

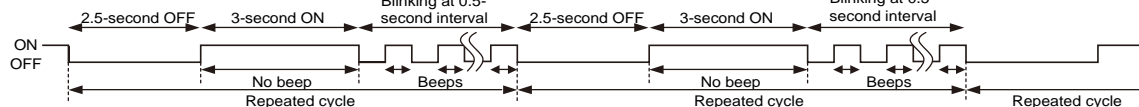



2. Table of indoor unit failure mode recall function

Left lamp of OPERATION INDICATOR lamp	Abnormal point (Failure mode)	Condition	Remedy
Not lit	Normal	—	—
1-time blink every 0.5-second	Room temperature thermistor	The room temperature thermistor short or open circuit is detected every 8 seconds during operation.	Refer to the characteristics of the room temperature thermistor (10-7.).
2-time blink 2.5-second OFF	Indoor coil thermistor	The indoor coil thermistor short or open circuit is detected every 8 seconds during operation.	Refer to the characteristics of the main indoor coil thermistor, the sub indoor coil thermistor (10-7.).
3-time blink 2.5-second OFF	Serial signal	The serial signal from outdoor unit is not received for a maximum of 6 minutes.	Refer to 10-6.Ⓒ "How to check miswiring and serial signal error".
11-time blink 2.5-second OFF	Indoor fan motor	The rotational frequency feedback signal is not emitted for the 12 seconds after the indoor fan is operated.	Refer to 10-6.Ⓐ "Check of indoor fan motor".
12-time blink 2.5-second OFF	Indoor control system	It cannot properly read data in the nonvolatile memory of the indoor electronic control P.C. board.	Replace the indoor electronic control P.C. board.

NOTE: Blinking patterns of this mode differ from the ones of TROUBLESHOOTING CHECK TABLE (10-4.).

10-3. INSTRUCTION OF TROUBLESHOOTING

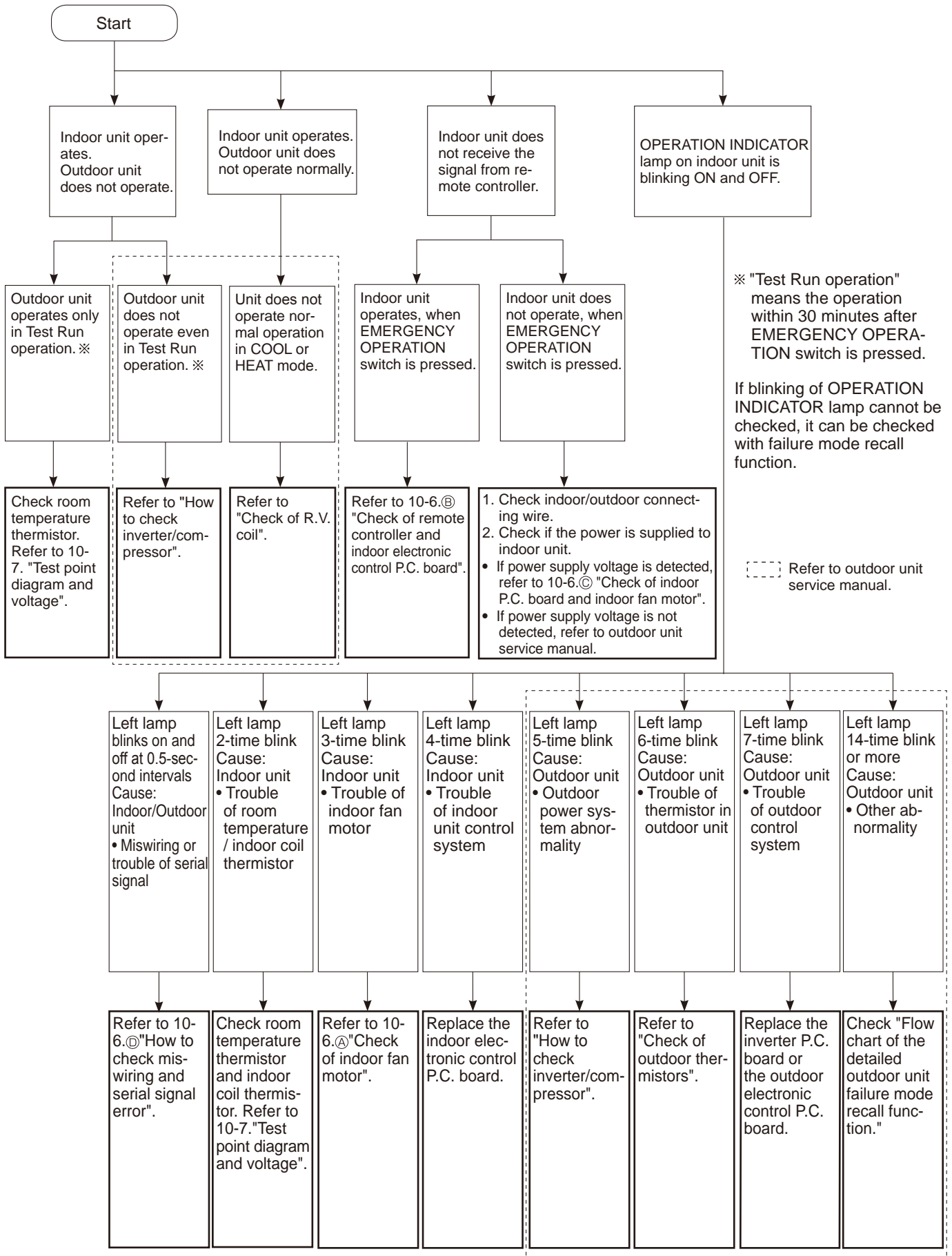

10-4. TROUBLESHOOTING CHECK TABLE



































































Before taking measures, make sure that the symptom reappears for accurate troubleshooting.

When the indoor unit has started operation and detected an abnormality of the following condition (the first detection after the power ON), the indoor fan motor turns OFF and OPERATION INDICATOR lamp blinks.

OPERATION INDICATOR



-  Lit
-  Blinking
-  Not lit

No.	Abnormal point	Operation indicator lamp	Symptom	Condition	Remedy
1	Miswiring or serial signal	Left lamp blinks. 0.5-second ON       0.5-second OFF	Indoor unit and outdoor unit do not operate.	The serial signal from the outdoor unit is not received for 6 minutes.	<ul style="list-style-type: none"> Refer to 10-6. ⑩ "How to check miswiring and serial signal error".
2	Indoor coil thermistor Room temperature thermistor	Left lamp blinks. 2-time blink        2.5-second OFF		The indoor coil or the room temperature thermistor is short or open circuit.	<ul style="list-style-type: none"> Refer to the characteristics of indoor coil thermistor, and the room temperature thermistor (10-7.).
3	Indoor fan motor	Left lamp blinks. 3-time blink         2.5-second OFF		The rotational frequency feedback signal is not emitted during the indoor fan operation.	<ul style="list-style-type: none"> Refer to 10-6. ⑪ "Check of indoor fan motor".
4	Indoor control system	Left lamp blinks. 4-time blink         2.5-second OFF		It cannot properly read data in the nonvolatile memory of the indoor electronic control P.C. board.	<ul style="list-style-type: none"> Replace the indoor electronic control P.C. board.
5	Outdoor power system	Left lamp blinks. 5-time blink         2.5-second OFF		It consecutively occurs 3 times that the compressor stops for overcurrent protection or start-up failure protection within 1 minute after start-up.	<ul style="list-style-type: none"> Refer to "How to check of inverter/compressor". Refer to outdoor unit service manual Check the stop valve.
6	Outdoor thermistors	Left lamp blinks. 6-time blink         2.5-second OFF		The outdoor thermistors short or open circuit during the compressor operation.	<ul style="list-style-type: none"> Refer to "Check of outdoor thermistor". Refer to outdoor unit service manual.
7	Outdoor control system	Left lamp blinks. 7-time blink         2.5-second OFF		It cannot properly read data in the nonvolatile memory of the inverter P.C. board or the outdoor electronic control P.C. board.	<ul style="list-style-type: none"> Replace the inverter P.C. board or the outdoor electronic control P.C. board. Refer to outdoor unit service manual.
8	Other abnormality	Left lamp blinks. 14-time blink or more             2.5-second OFF		An abnormality other than above mentioned is detected.	<ul style="list-style-type: none"> Check the stop valve. Check the 4-way valve. Confirm the abnormality in detail using the failure mode recall function for outdoor unit.
9	Outdoor control system	Upper lamp lights up 		Outdoor unit does not operate	It cannot properly read data in the nonvolatile memory of the inverter P.C. board.



OPERATION INDICATOR



- Lit
- ⊙ Blinking
- Not lit

No.	Abnormal point	Operation indicator lamp	Symptom	Condition	Remedy
1	MXZ type Operation mode setting	Left lamp lights and right lamp blinks. 2.5-second OFF	Outdoor unit operates but indoor unit does not operate.	The operation mode of the each indoor unit is differently set to COOL (includes DRY, FAN) and HEAT at the same time, the operation mode of the indoor unit that has operated at first has the priority.	<ul style="list-style-type: none"> • Unify the operation mode. Refer to outdoor unit service manual.

10-5. TROUBLE CRITERION OF MAIN PARTS

Part name	Check method and criterion	Figure				
Room temperature thermistor (RT11) Indoor coil thermistor (RT12, RT13)	Measure the resistance with a tester. Refer to 10-7. "Test point diagram and voltage", "Indoor electronic control P.C. board", for the chart of thermistor.					
Indoor fan motor (MF)	Check 10-6.Ⓐ "Check of indoor fan motor".					
Vane motor (MV)	Measure the resistance between the terminals with a tester. (Temperature: 10 - 30°C) <table border="1" style="margin-left: auto; margin-right: auto;"> <thead> <tr> <th>Color of the lead wire</th> <th>Normal</th> </tr> </thead> <tbody> <tr> <td>RED-BLK</td> <td>262 ~ 328 Ω</td> </tr> </tbody> </table>	Color of the lead wire	Normal	RED-BLK	262 ~ 328 Ω	
Color of the lead wire	Normal					
RED-BLK	262 ~ 328 Ω					

10-6. TROUBLESHOOTING FLOW

A Check of indoor fan motor

The indoor fan motor error has occurred, and the indoor fan does not operate.

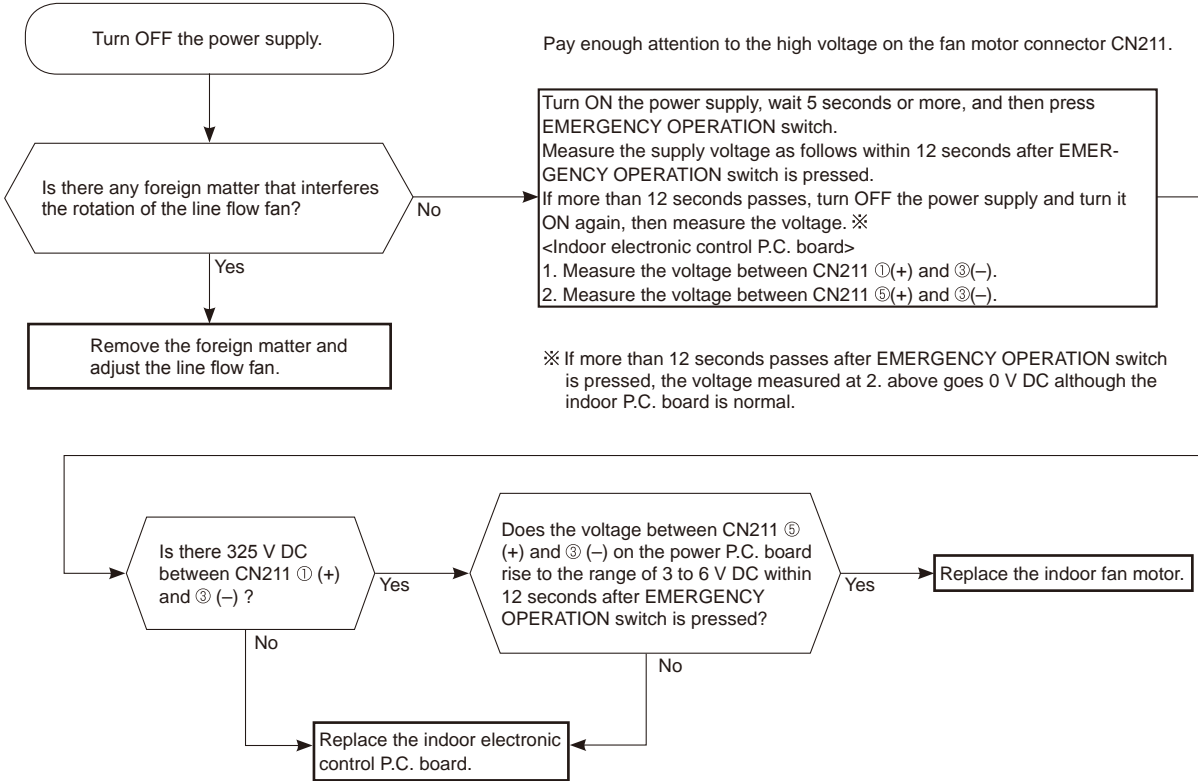

The indoor fan motor error has occurred, and the indoor fan repeats "12-second ON and 30-second OFF" 3 times, and then stops.

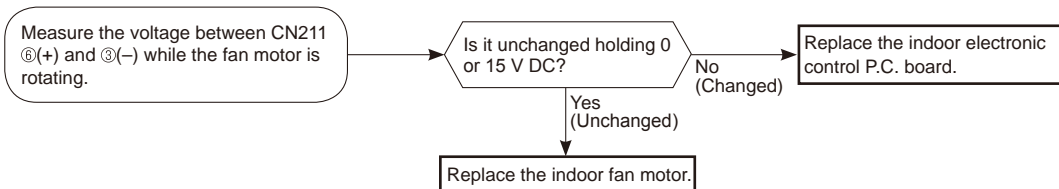

B Check of remote controller and indoor electronic control P.C. board

※Check if the remote controller is exclusive for this air conditioner.

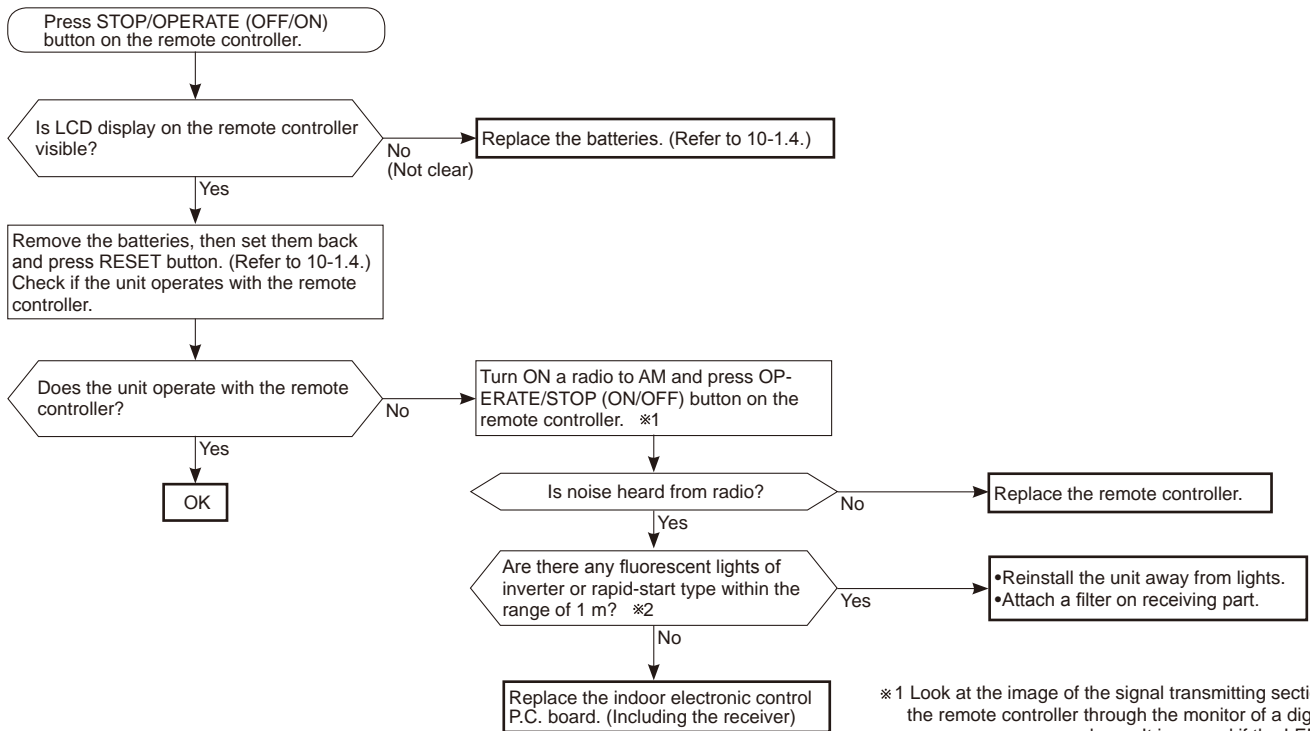

※ 1 Look at the image of the signal transmitting section of the remote controller through the monitor of a digital camera or a camera phone. It is normal if the LED of the signal transmitting section lights up when the OPERATE/STOP (ON/OFF) button on the remote controller is pressed. However, it may be difficult to see the illuminated LED of the signal transmitting section with a smartphone camera.

※ 2 If the inverter fluorescent light is turned on when the room is cool, the unit may have difficulty receiving the signal from the remote controller or may not be able to operate with it; if the inverter fluorescent light is turned on when the room is warm, the unit may be able to operate with the remote controller.

© Check of indoor P.C. board and indoor fan motor

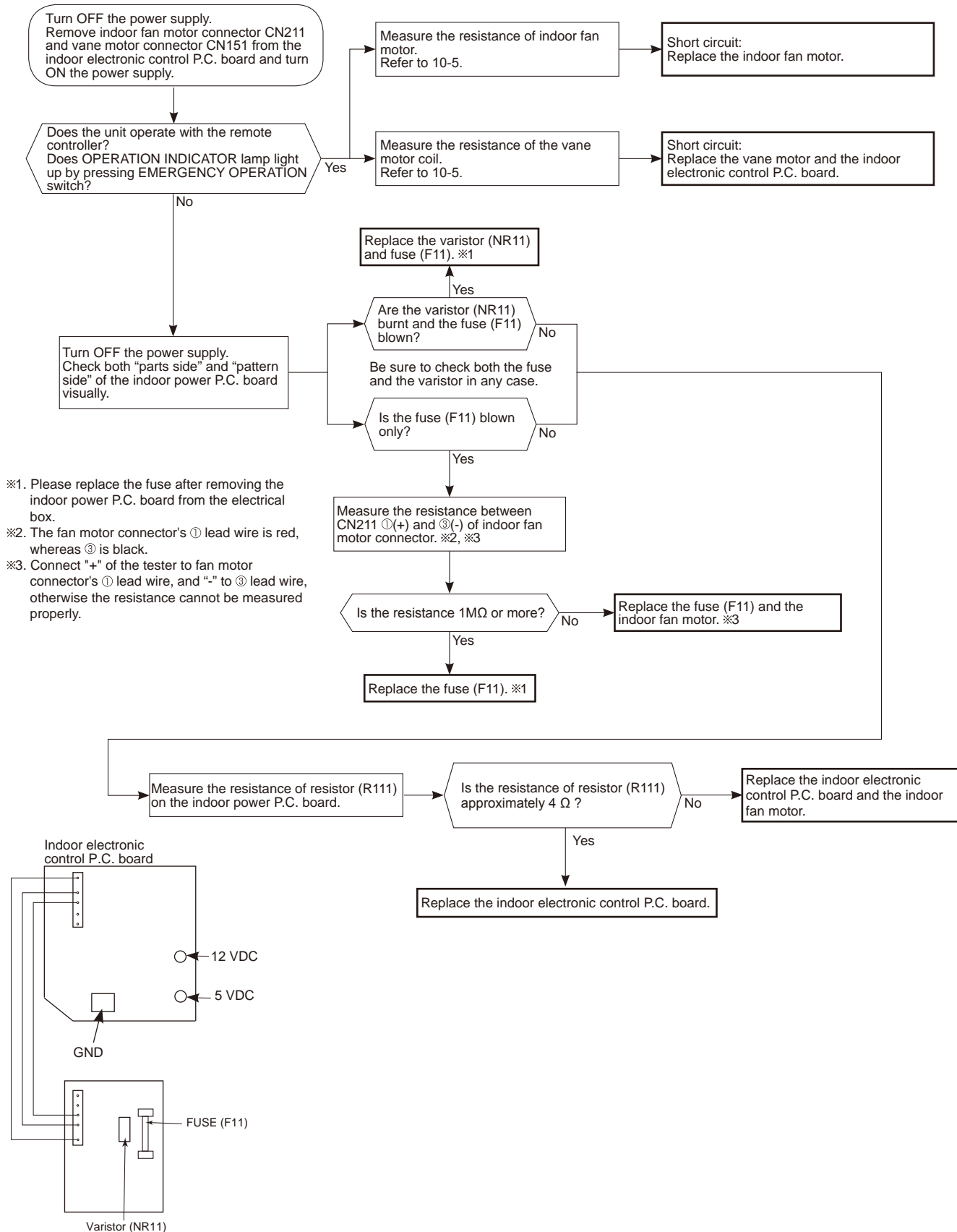

D How to check miswiring and serial signal error

NOTE: Refer to the outdoor unit service manual.

MUY Type

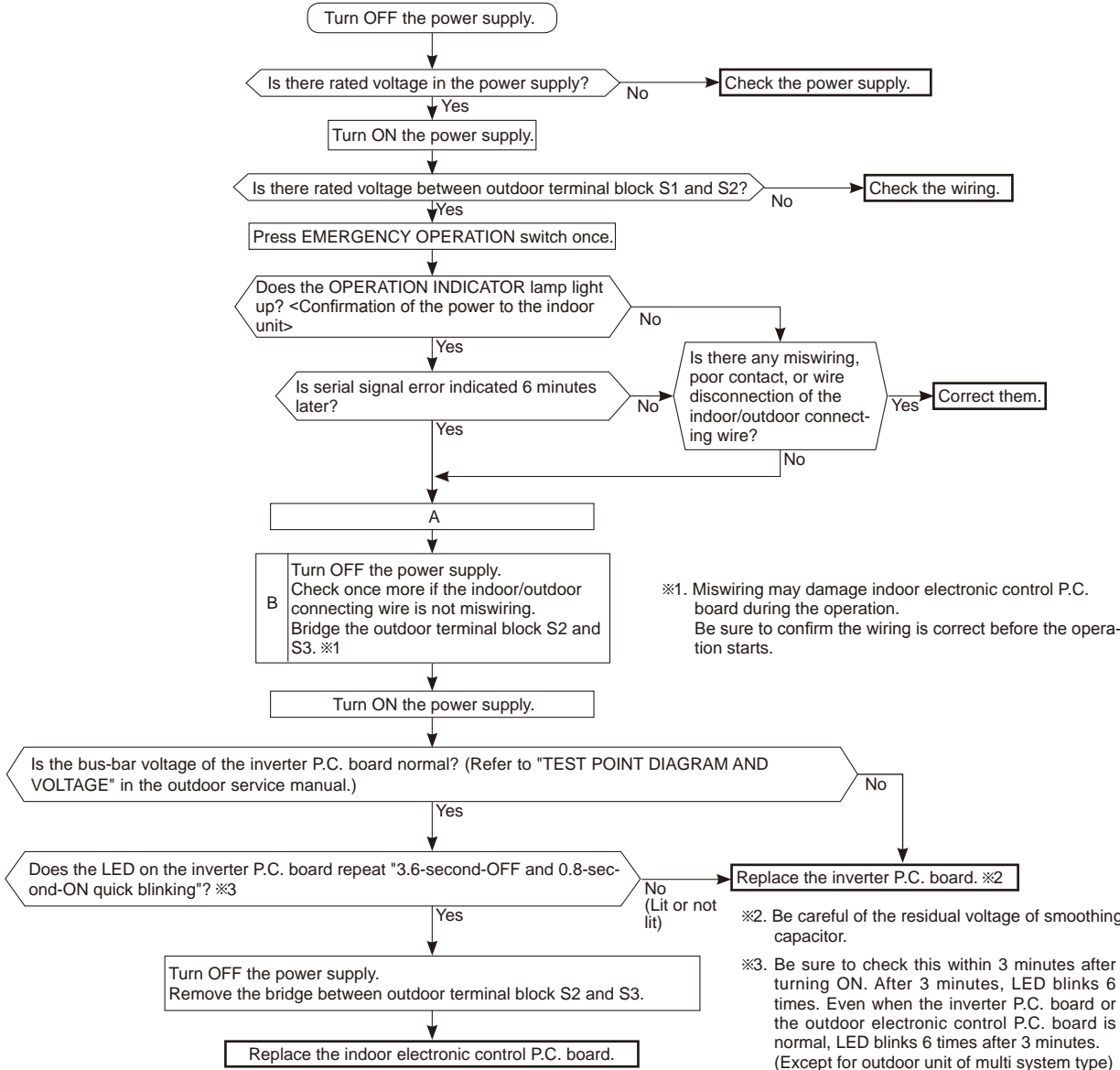

※1. Miswiring may damage indoor electronic control P.C. board during the operation. Be sure to confirm the wiring is correct before the operation starts.

※2. Be careful of the residual voltage of smoothing capacitor.

※3. Be sure to check this within 3 minutes after turning ON. After 3 minutes, LED blinks 6 times. Even when the inverter P.C. board or the outdoor electronic control P.C. board is normal, LED blinks 6 times after 3 minutes. (Except for outdoor unit of multi system type)

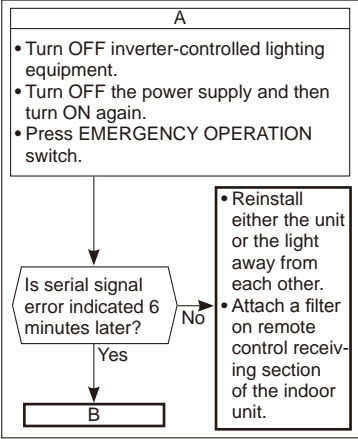

MXZ Type

LED indication for communication status

Communication status is indicated by the LED.

Unit status

Blinking: normal communication

Lighting: abnormal communication or not connected

Pattern 1 and 2 is repeatedly displayed alternately. Each pattern is displayed for 10 seconds.

NOTE: "Lighting" in the table below does not indicate abnormal communication.

Outdoor control P.C. board

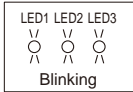

Pattern	LED 1	LED 2	LED 3
1	Unit A status	Unit B status	Lit
2	Unit C status	Unit D status	Not lit
3	Unit E status	—	Blinking

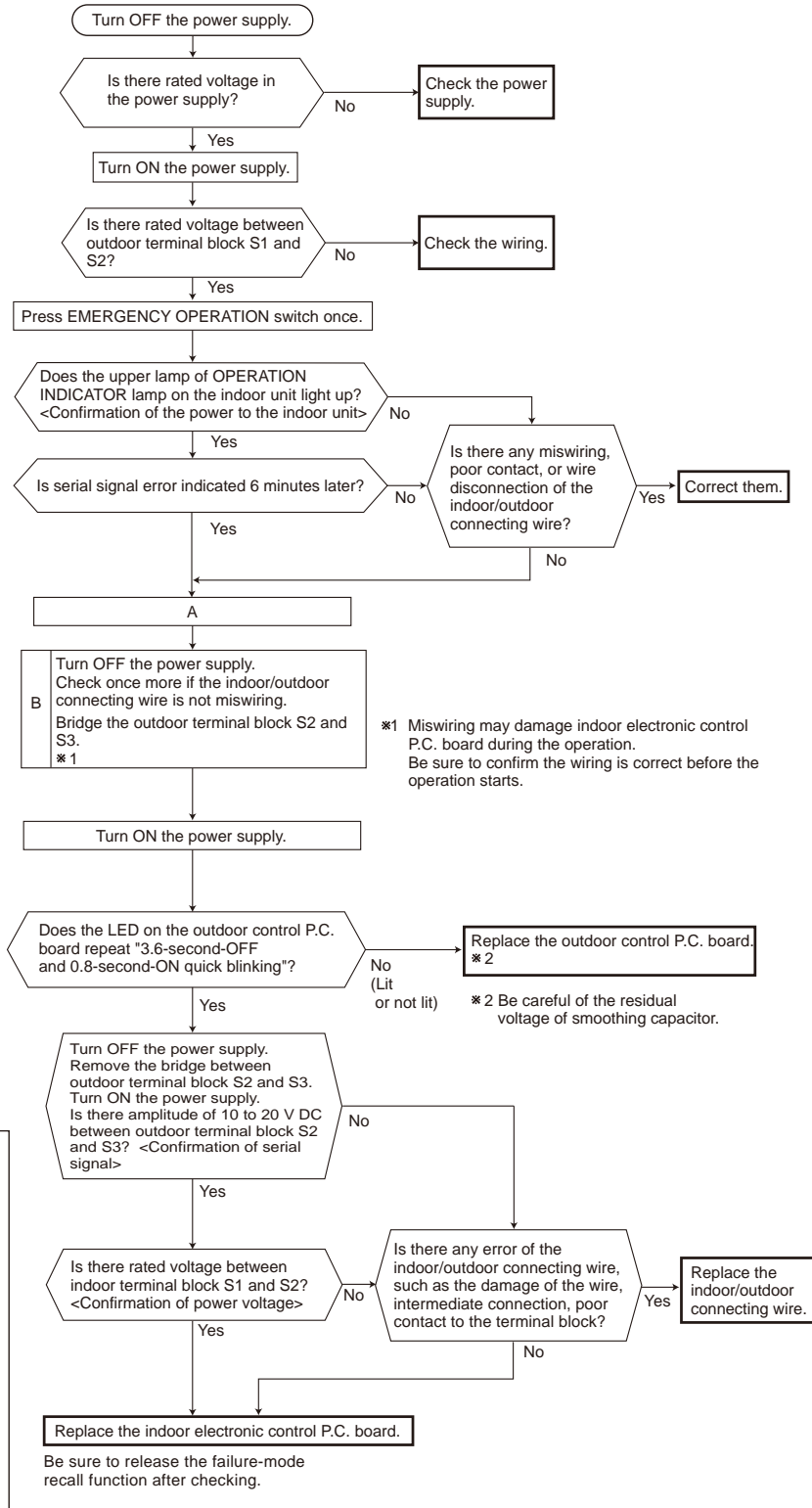

E Electromagnetic noise enters into TV sets or radios

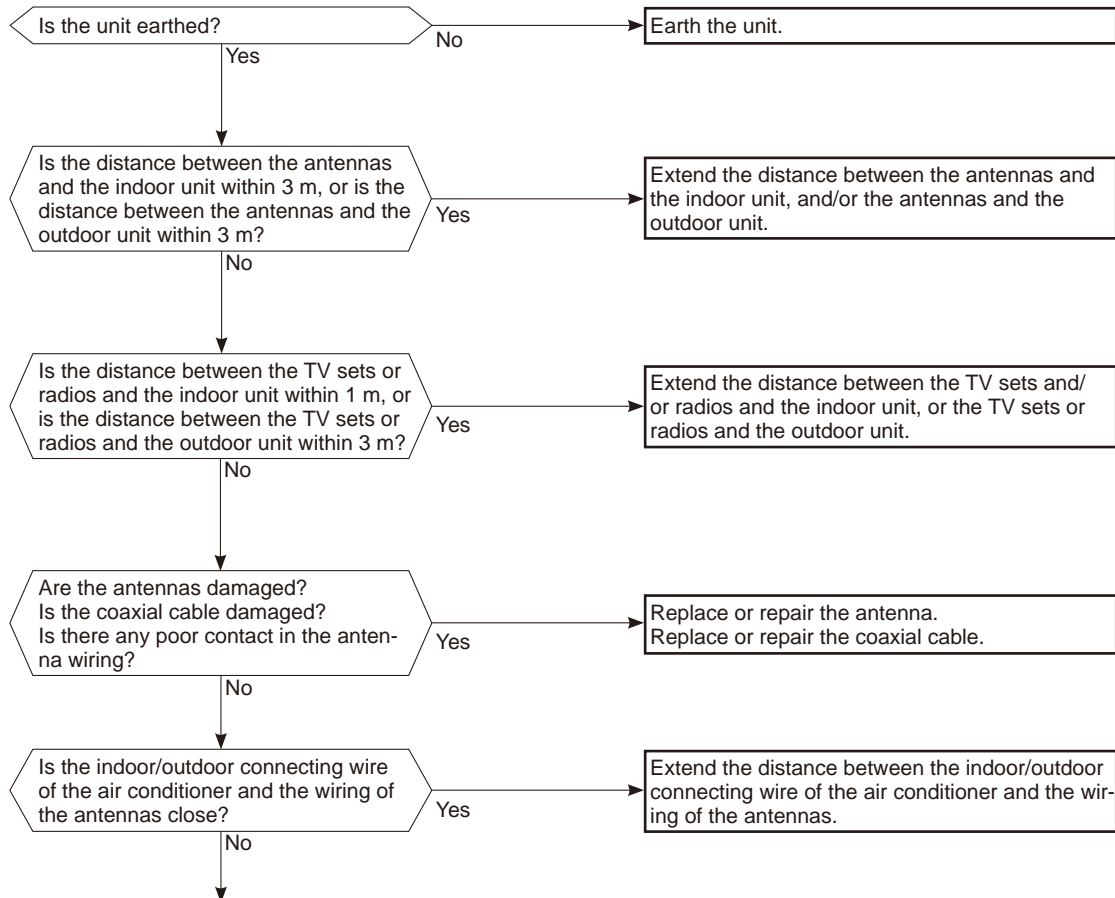

Even if all of the above conditions are fulfilled, the electromagnetic noise may enter, depending on the electric field strength or the installation condition (combination of specific conditions such as antennas or wiring).
Check the following before asking for service.

1. Devices affected by the electromagnetic noise
TV sets, radios (FM/AM broadcast, shortwave)
2. Channel, frequency, broadcast station affected by the electromagnetic noise
3. Channel, frequency, broadcast station unaffected by the electromagnetic noise
4. Layout of:
indoor/outdoor unit of the air conditioner, indoor/outdoor wiring, earth wire, antennas, wiring from antennas, receiver
5. Electric field intensity of the broadcast station affected by the electromagnetic noise
6. Presence or absence of amplifier such as booster
7. Operation condition of air conditioner when the electromagnetic noise enters in
 - 1) Turn OFF the power supply once, and then turn ON the power supply. In this situation, check for the electromagnetic noise.
 - 2) Within 3 minutes after turning ON the power supply, press STOP/OPERATE (OFF/ON) button on the remote controller for power ON, and check for the electromagnetic noise.
 - 3) After a short time (3 minutes later after turning ON), the outdoor unit starts running. During operation, check for the electromagnetic noise.
 - 4) Press STOP/OPERATE (OFF/ON) button on the remote controller for power OFF, when the outdoor unit stops but the indoor/outdoor communication still runs on. In this situation, check for the electromagnetic noise.

10-7. TEST POINT DIAGRAM AND VOLTAGE

1. Indoor electronic control P.C. board, indoor terminal P.C. board and power monitor receiver SW P.C. board MSZ-HR25VF MSZ-HR35VF MSZ-HR42VF MSZ-HR50VF

Indoor electronic control P.C. board

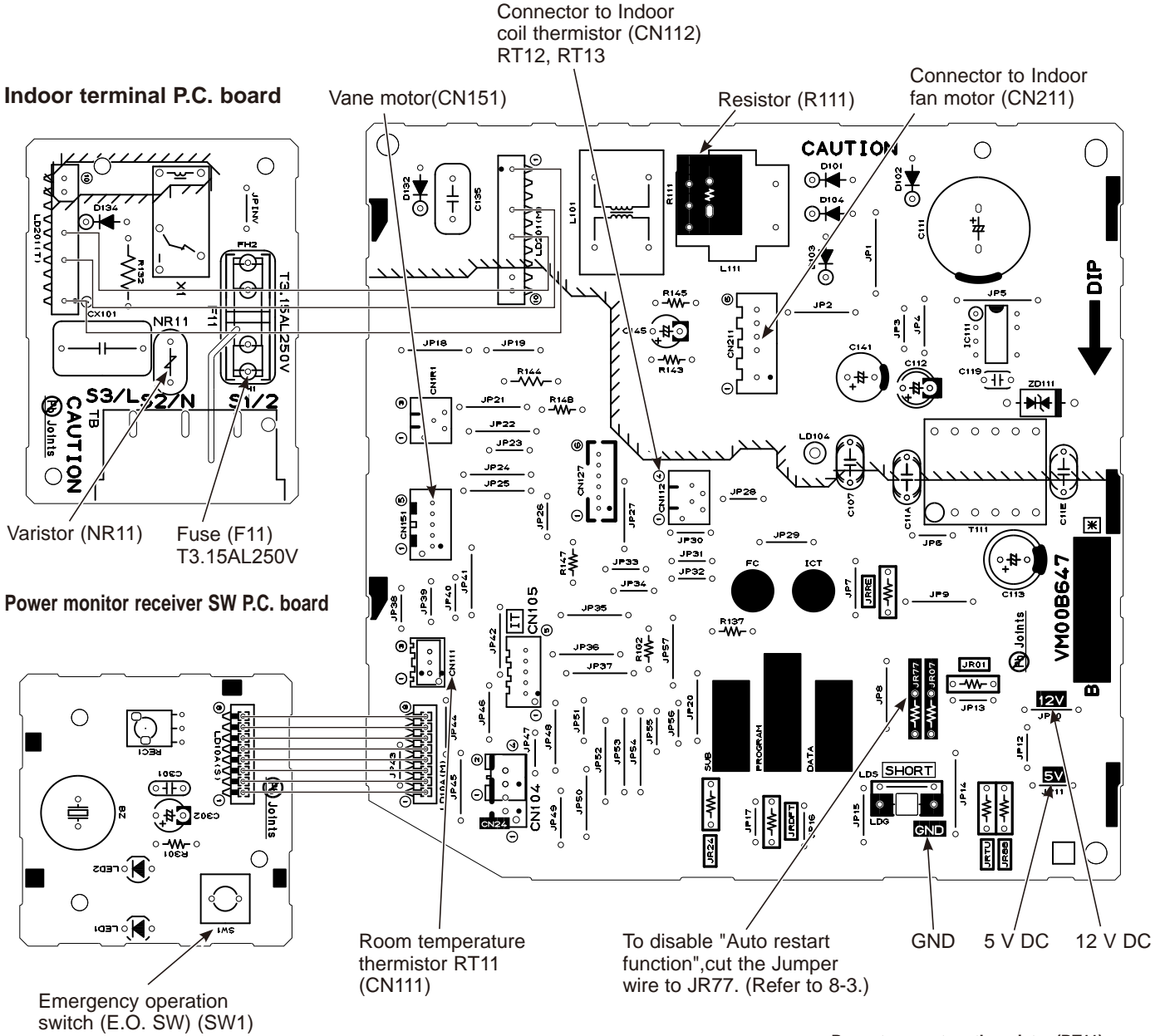

Room temperature thermistor (RT11)
Indoor coil thermistor (RT12, RT13)

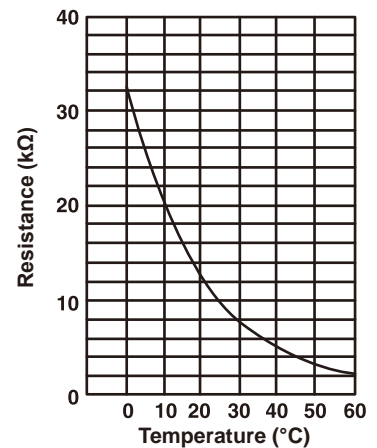

<Detaching method of the terminal with locking mechanism>

The terminal which has the locking mechanism can be detached as shown below.

There are following 2 types of the terminal with locking mechanism.

The terminal without locking mechanism can be detached by pulling it out.

Check the shape of the terminal before detaching.

(1) Slide the sleeve and check if there is a locking lever or not.

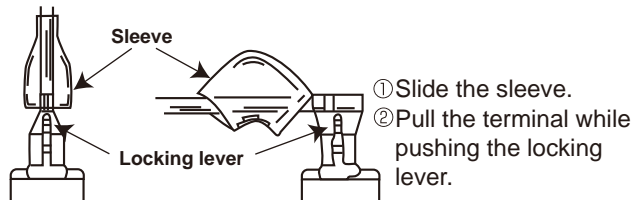

(2) The terminal with this connector shown below has the locking mechanism.

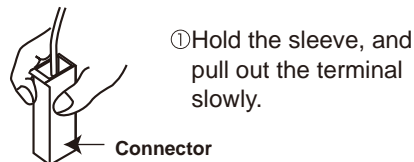

11-1. MSZ-HR25VF MSZ-HR35VF MSZ-HR42VF MSZ-HR50VF

NOTE: Turn OFF the power supply before disassembly.

→ : Indicates the visible parts in the photos/figures.
---→ : Indicates the invisible parts in the photos/figures.

OPERATING PROCEDURE	PHOTOS/FIGURES
<p>1. Removing the panel</p> <p>(1) Remove the screw caps on the panel and remove the screws of the panel.</p> <p>(2) Pull the panel slightly toward you, and then remove the panel by pushing it upward.</p>	<p>Photo 1</p>

OPERATING PROCEDURE

2. Removing the indoor terminal P.C. board, indoor electronic control P.C. board, and power monitor receiver SW P.C. board and the electrical box

<Removing the electrical box>

- (1) Remove the panel. (Refer to section 1.)
Remove the right corner box.
- (2) Remove the screw of the V.A. clamp.
Remove the V.A. clamp and the indoor/outdoor connecting wire.
- (3) Remove the screws of the electrical cover and electrical cover.
- (4) Remove the connector of the coil thermistor from the indoor electronic control P.C. board.
Remove the wires of the indoor coil thermistors from the water cover, and remove the tab of the earth wire.
- (5) Remove the water cover.
- (6) Remove the following connectors from the indoor electronic control P.C. board:
CN151 (Vane motor)
CN211 (Fan motor)
- (7) Remove the upper catch of the electrical box, and pull out the electrical box.

NOTE:

To attach the electrical box, pass the wires connecting the indoor power monitor receiver SW P.C. board and the indoor electronic control P.C. board through A. Pass the lead wires of the fan motor through B as shown in the Photo 3.

<Removing the indoor terminal P.C. board, indoor electronic control P.C. board, and power monitor receiver SW P.C. board>

- (8) Remove the screw of the terminal block and remove the earth wire connected to the electrical box from the indoor electronic control P.C. board.
- (9) Remove the power monitor receiver SW P.C. board holder from the electrical box.
- (10) Unhook the hooks of the power monitor receiver switch P.C. board holder (Photo 4) and remove the power monitor receiver SW P.C. board.
- (11) Remove the room temperature thermistor from the electrical box .
Remove the indoor terminal P.C. board and the indoor electronic control P.C board from the electrical box.

*1: Remove the insulations when replace the indoor electric control P.C. board.

Photo 4

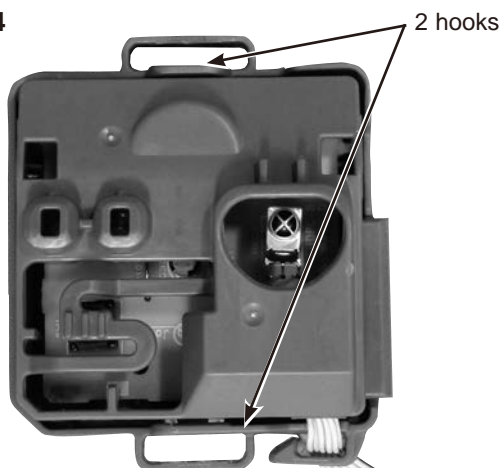

PHOTOS/FIGURES

Photo 2

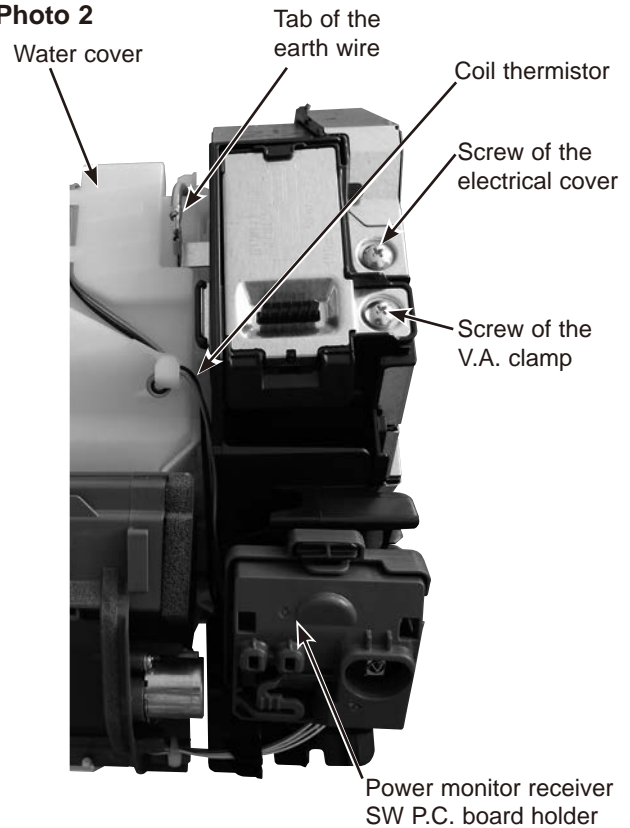
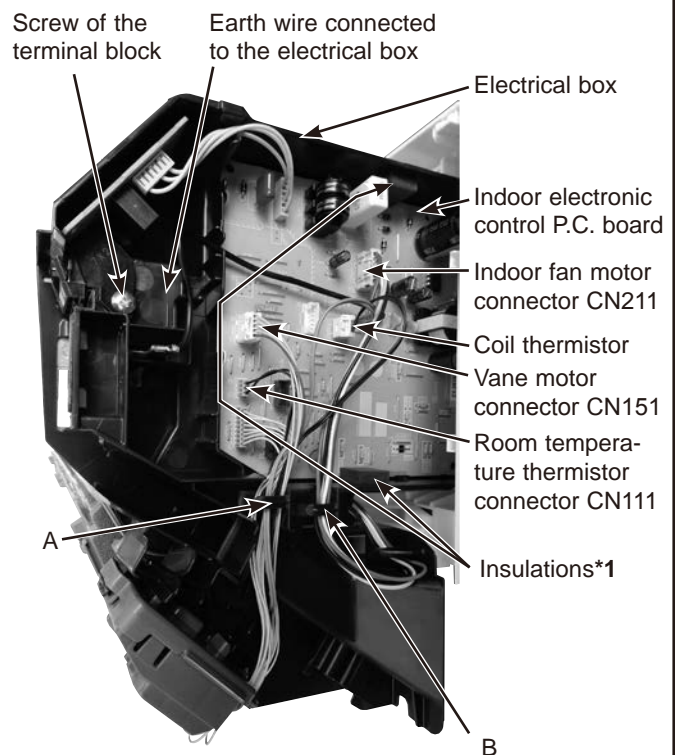

Photo 3



OPERATING PROCEDURE

3. Removing the nozzle assembly and the vane motor

<Removing the nozzle assembly>

- (1) Remove the panel (Refer to section 1.) and the corner box.
- (2) Remove the V.A. clamp, and then the indoor/outdoor connecting wire. (Refer to section 2.)
- (3) Remove the electrical cover. (Refer to section 2.)
- (4) Disconnect the following connectors on the electronic control P.C. board:
CN151 (Vane motor)
- (5) Pull out the drain hose from the nozzle assembly and remove the nozzle assembly.

<Removing the vane motor>

- (6) Cut the fixing band of the vane motor wire. (Photo 5)
- (7) Remove the screws of the vane motor and remove the vane motor. (Photo 6)
- (8) Disconnect the connector from the vane motor.

PHOTOS/FIGURES

Photo 5

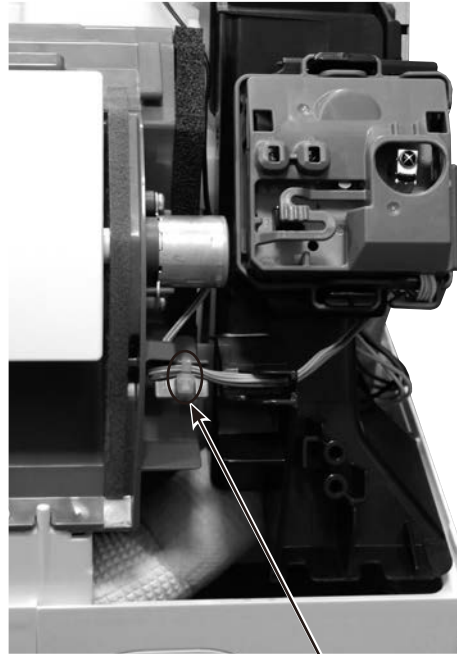

Fixing band of the vane motor wire

Photo 6



Screws of the vane motor

OPERATING PROCEDURE

4. Removing the indoor fan motor, the indoor coil thermistor and the line flow fan

- (1) Remove the panel. (Refer to section 1.)
Remove the corner box.
- (2) Remove the electrical box and the nozzle assembly.
(Refer to section 2,3.)
- (3) Remove the screws fixing the motor bed.
- (4) Loosen the screw fixing the line flow fan.
- (5) Remove the motor bed together with the indoor fan motor and the motor band.
- (6) Disconnect the lead wire of the fan motor from the motor band.
- (7) Disengage the hooks of the motor band and remove the motor band. Pull out the indoor fan motor.
- (8) Remove the indoor coil thermistor from the heat exchanger.
* Install the indoor coil thermistor in its former position when assembling it.
- (9) Remove the screws fixing the left side of the heat exchanger.
- (10) Lift the heat exchanger, and pull out the line flow fan to the lower-left.
* When attaching the line flow fan, screw the line flow fan so 4 mm gap is provided between the right end of the line flow fan and the right wall of the air passage of the box (Figure 1).

Figure 1

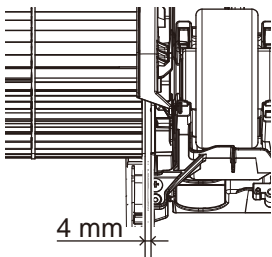
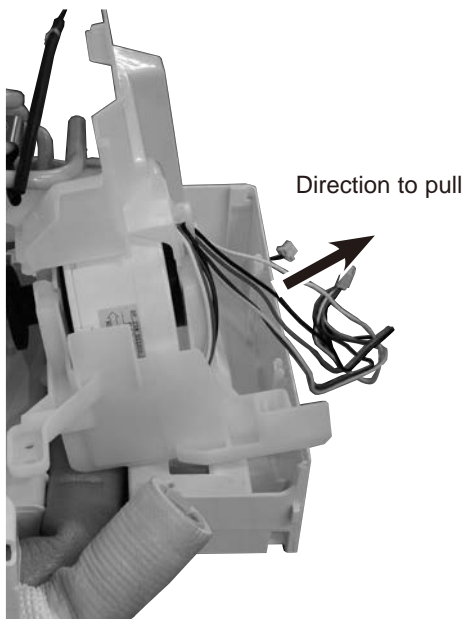
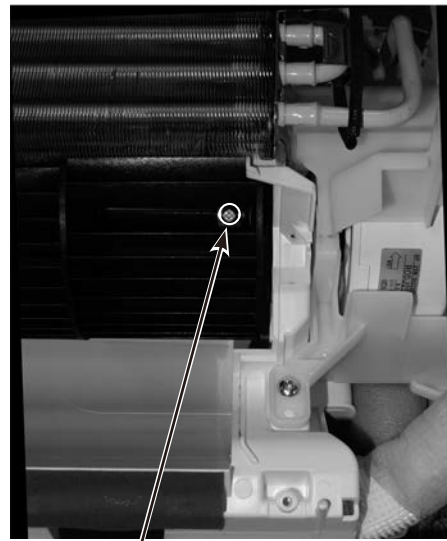

Photo 10



PHOTOS/FIGURES

Photo 7



Screw of the line flow fan

Photo 8

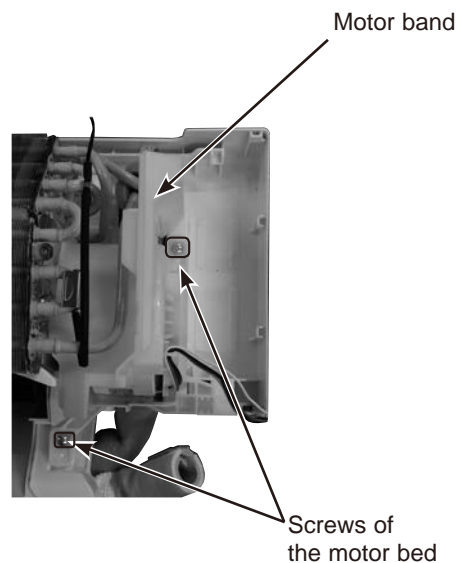
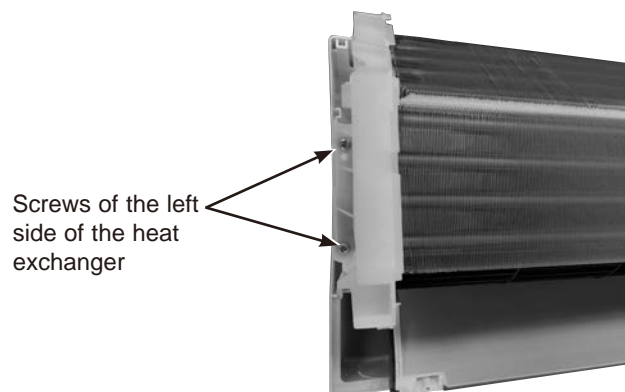

Photo 9



Fixing the indoor coil thermistor

※ There are 2 forms of parts for fixing the indoor coil thermistor.

Clip shape



Holder shape



When fixing the indoor coil thermistor to the clip-shape/holder-shape part, the lead wire should point down.

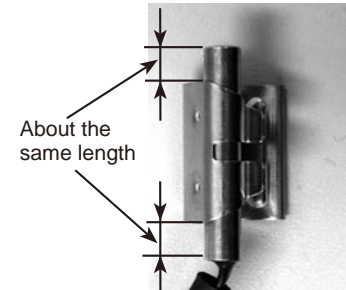

Position and procedure for mounting the clip-shape part

1. Set the indoor coil thermistor in the center of the clip-shape part.



2. Check the (marked) mounting position.



3. Mount the clip-shape part.



NOTE:

- Take care to avoid loss and accidental falling of the clip-shape part inside the unit.
- Mount the clip-shape part on the marked position.
- Do not pull the lead wire when removing the indoor coil thermistor.

mitsubishi electric corporation

HEAD OFFICE: TOKYO BUILDING, 2-7-3, MARUNOUCHI, CHIYODA-KU, TOKYO 100-8310, JAPAN

© Copyright 2019 MITSUBISHI ELECTRIC CORPORATION

Published: Aug. 2019. No. OBH844

Made in Japan

Specifications are subject to change without notice.